

# NT620S/620C

## Programmable Terminal

### Operation Manual

*Revised August 1997*

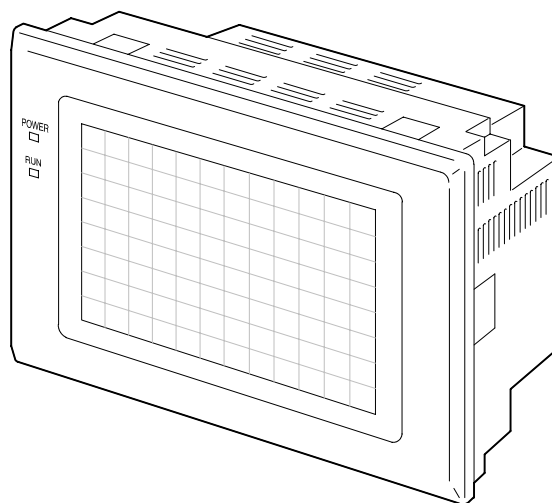



## **OMRON Product References**

All OMRON products are capitalized in this manual. The word "Unit" is also capitalized when it refers to an OMRON product, regardless of whether or not it appears in the proper name of the product.

The abbreviation "Ch," which appears in some displays and on some OMRON products, often means "word" and is abbreviated "Wd" in documentation in this sense.

The abbreviation "PC" means Programmable Controller and is not used as an abbreviation for anything else.

The abbreviation "Host" means PC that controls NT620S/620C.

## **Visual Aids**

The following headings appear in the left column of the manual to help you locate different types of information.

- |                   |   |
|-------------------|---|
| <b>Note</b>       | Indicates information of particular interest for efficient and convenient operation of the product. |
| <b>1, 2, 3...</b> | 1. Indicates lists of one sort or another, such as procedures, checklists, etc.                     |

## **© OMRON, 1997**

All rights reserved. No part of this publication may be reproduced, stored in a retrieval system, or transmitted, in any form, or by any means, mechanical, electronic, photocopying, recording, or otherwise, without the prior written permission of OMRON.

No patent liability is assumed with respect to the use of the information contained herein. Moreover, because OMRON is constantly striving to improve its high-quality products, the information contained in this manual is subject to change without notice. Every precaution has been taken in the preparation of this manual. Nevertheless, OMRON assumes no responsibility for errors or omissions. Neither is any liability assumed for damages resulting from the use of the information contained in this publication.



# TABLE OF CONTENTS

<b>PRECAUTIONS</b> .....	<b>xi</b>
1 Intended Audience .....	xii
2 General Precautions .....	xii
3 Safety Precautions .....	xii
<b>SECTION 1</b>	
<b>Functions of the NT620S/620C</b> .....	<b>1</b>
1-1 Role and Operation of NT620S/620C .....	2
1-2 Functions of NT620S/620C .....	4
1-3 System Configuration .....	8
1-4 Communication Using the Direct Connection Function .....	11
1-5 Communication Using the Memory Link .....	17
1-6 Before Operating .....	19
<b>SECTION 2</b>	
<b>Hardware Settings and Connections</b> .....	<b>21</b>
2-1 Description of Parts and Settings .....	22
2-2 Installation .....	25
2-3 Connecting to the Support Tool .....	29
2-4 Installing the System Program .....	30
2-5 Connection to a PC by the Host Link .....	32
2-6 Connection to a PC by the NT Link (1:1) .....	44
2-7 Connection to a PC by the NT Link (1:N) .....	49
2-8 Communication with the Host Using Memory Link .....	56
2-9 Connecting a Printer .....	57
<b>SECTION 3</b>	
<b>System Menu Operation</b> .....	<b>58</b>
3-1 Operation Flow by the System Menu .....	59
3-2 Starting the NT620S/620C .....	60
3-3 Operation Modes and the System Menu .....	61
3-4 Initializing Memory .....	65
3-5 Setting the Conditions of Communications with the PC by Using the Memory Switches .....	72
3-6 Registering the Screen Data .....	80
3-7 Starting the Operation .....	84
3-8 Various System Settings .....	85
3-9 System Maintenance .....	96
<b>SECTION 4</b>	
<b>NT620S/620C Functions</b> .....	<b>117</b>
4-1 Creating and Transmitting Screen Data .....	118
4-2 Outline of Functions .....	124
4-3 Screen Display .....	135
4-4 Memory Tables .....	139
4-5 Graphs .....	145
4-6 LAMP .....	157

4-7	Touch Switches .....	161
4-8	Numeral Setting .....	170
4-9	Character-String Setting .....	182
4-10	Pop-Up Window Function .....	185
4-11	Alarm List & History Display Functions .....	192

## **SECTION 5**

### **Using Host Link/NT Link ..... 199**

5-1	Outline of Host Link / NT Link Operation .....	200
5-2	Memory Tables and Graphs .....	215
5-3	Lamps and Touch Switches .....	231
5-4	Numeral and Character-string Setting .....	241
5-5	Alarm Lists .....	247
5-6	Clock Function .....	251
5-7	NT620S/620C Status Control .....	257
5-8	Notification of the Operating Status to the PC (Determining the NT620S/620C Operating Status) .....	263

## **SECTION 6**

### **Using Memory Link ..... 267**

6-1	Operation of the Memory Link .....	268
6-2	Outline of Communications .....	271
6-3	Commands/Responses .....	275

## **SECTION 7**

### **Troubleshooting and Maintenance ..... 297**

7-1	Hardware Faults .....	298
7-2	Responding to Displayed Error Messages .....	300
7-3	Maintenance of the NT620S/620C .....	304
7-4	Inspection and Cleaning .....	310

## **APPENDICES ..... 313**

A.	Specifications .....	313
B.	Dimensions .....	321
C.	Handling the RS-232C/RS-422 Converter Unit .....	324
D.	NT620S/620C Installation Environment .....	326
E.	Transporting and Storing the NT620S/NT620C .....	328
F.	NT620S/620C Internal Processing .....	329
G.	Method for Making the Cable for Connection to the PC .....	332
H.	Making the Cable for Connection to the Support Tool .....	343
I.	Connecting to an RS-232C/RS-422 Converter Unit .....	344
J.	Model List .....	346
K.	Option List .....	351
L.	PC Memory Map .....	354
M.	Special Characters .....	355

## **INDEX ..... 358**

## ***About this Manual:***

This manual describes the basic functions and operation procedures of the NT-series programmable terminal NT620S/620C, its operations when connected to a PC or a Host, and includes the sections described below.

Please read this manual carefully and be sure you understand the information provided before attempting to install and operate the NT-series programmable terminal NT620S/620C.

**Section 1** describes the operation functions, system configuration, and the direct connection function of the NT620S/620C.

**Section 2** describes the hardware settings, installation to an operation panel, connection to optional devices and PC.

**Section 3** describes the operation of the System Menu and the maintenance of the NT620S/620C.

**Section 4** describes the functions of the NT620S/620C when it is connected to a PC.

**Section 5** describes how to use the NT620S/620C when it is connected to the PC using the host link or NT link.

**Section 6** describes how to use the NT620S/620C when it is connected to a Host using the memory link.

**Section 7** describes the procedures to follow when the NT620S/620C does not operate correctly.

**APPENDIX** describes the specifications and the method for making connecting cables, and includes an area list for the PC.

## ***Related Manuals and Their Contents:***

The related manuals are listed below.

The □ symbol at the end of the manual number is the revision history symbol.

### **[Operating the programmable terminal and communicating with the host]**

- NT620S/NT620C Programmable Terminal Operation Manual (V033-E1-□)  
..... This manual

This operation manual is the manual for the NT620S/620C itself.

The NT620S/620C is a unit which integrates a programmable terminal body and host interface unit. This operation manual describes the functions and handling of both the programmable terminal body and the host interface function.

### **[Creating and transferring screen data]**

- NT-series Support Tool Operation Manual (V028-E1-□)

The screens displayed on the NT620S/620C are created with the support tool and transferred to the NT620S/620C. This manual describes how to create and transfer screen data.



# PRECAUTIONS

This section provides general precautions for using the Programmable Terminal.

**The information contained in this section is important for the safe and reliable application of the Programmable Terminal. You must read this section and understand the information contained before attempting to set up or operate a Programmable Terminal.**

- 1 Intended Audience ..... xii
- 2 General Precautions ..... xii
- 3 Safety Precautions ..... xii

## 1 Intended Audience

This manual is intended for the following personnel, who must also have knowledge of electrical systems (an electrical engineer or the equivalent).

- Personnel in charge of installing FA systems.
- Personnel in charge of designing FA systems.
- Personnel in charge of managing FA systems and facilities.

## 2 General Precautions

The user must operate the product according to the performance specifications described in the operation manuals.

Before using the product under conditions which are not described in the manual or applying the product to nuclear control systems, railroad systems, aviation systems, vehicles, combustion systems, medical equipment, amusement machines, safety equipment, and other systems, machines, and equipment that may have a serious influence on lives and property if used improperly, consult your OMRON representative.

Make sure that the ratings and performance characteristics of the product are sufficient for the systems, machines, and equipment, and be sure to provide the systems, machines, and equipment with double safety mechanisms.

This manual provides information for using the Programmable Terminal. Be sure to read this manual before attempting to use the software and keep this manual close at hand for reference during operation.

 **WARNING** It is extremely important that Programmable Terminals and related devices be used for the specified purpose and under the specified conditions, especially in applications that can directly or indirectly affect human life. You must consult with your OMRON representative before applying Programmable Terminals to the abovementioned applications.

 **WARNING** Do not use input functions such as PT touch switches for applications where danger to human life or serious damage is possible, or for emergency switch applications.

## 3 Safety Precautions

Read these safety precautions carefully and make sure you understand them before using the Programmable Terminal so that you can use it safely and correctly.

### Safety Conventions and their Meanings

This operation manual uses the following conventions and symbols to indicate cautions, warnings, and dangers in order to ensure safe use of the PT. The cautions, warnings, and dangers shown here contain important information related to safety. The instructions in these cautions, warnings, and dangers must be observed.

The conventions used and their meanings are presented below.

 **DANGER!** Indicates information that, if not heeded, is likely to result in loss of life or serious injury.

 **WARNING** Indicates information that, if not heeded, could possibly result in loss of life or serious injury.

 **CAUTION** Indicates information that, if not heeded, could result in relatively serious or minor injury, damage to the product, or faulty operation.

 **WARNING:**

- Do not disassemble the unit or touch parts inside while the power is ON. You could sustain an electric shock.
- Turn the backlight off before replacing it. Otherwise you could sustain an electric shock.

 **Caution:**

- Be sure to switch the power OFF before replacement.
- Do not use the PT touch switch input functions for applications where danger to human life or serious property damage is possible, or for emergency switch applications.
- On unpacking the NT620S/NT620C, check its external appearance and confirm that there is no damage. Also confirm that there is no abnormal noise on shaking the NT620S/NT620C lightly.  
The product may malfunction if it is damaged.
- Before inserting or removing the connectors, make sure that the NT620S/NT620C and the PC are turned OFF.
- The thickness of applicable operation panel is 1.6 mm to 4.8 mm. All fittings must be tightened uniformly to a torque of 0.5 to 0.6 N·m in order to ensure water- and dust-resistance. The panel must not be soiled or warped, and must be able to support an installation that will remain secure and strong.
- During work at the panel, take care to ensure that no metal scraps enter the unit. Otherwise, the product may malfunction.
- After connecting the communication cable, be sure to lock the connectors with the screws. Otherwise the cable may disconnect, causing operation to fail.
- The cable's tensile load is 30 N. Do not subject it to loads greater than this. Otherwise a discontinuity may occur, causing operation to fail.
- Do not install the NT620S/NT620C at sites subject to the following conditions. Otherwise, the product may malfunction.

Severe temperature variations

Temperatures or humidities outside the ranges stated in the specifications

High humidity, condensation

Splashing chemical agents

Severe oil splashing

Corrosive or flammable gases

Strong vibrations or shocks

Direct exposure to wind and rain (outdoor sites)

Strong ultra-violet irradiation

- Take adequate measures to ensure shielding if the NT620S/NT620C is used at a location subject to any of the following conditions. Otherwise, the product may malfunction.

Static electricity, or noise from other equipment

Strong electromagnetic fields

Nearby power cables

Potential exposure to radioactivity

- Carry out grounding correctly in order to prevent misoperation due to noise.
  - When installing the PT in the operation panel, observe the following points.
    - Do not install the unit in locations directly exposed to chemicals or steam, or locations where there is excessive dust.
    - Do not install the unit at location where the ambient temperature goes outside the range 0 to 45 °C in the case of the NT620S and 0 to 40 °C in the case of the NT620C, or where the relative humidity goes outside the range 35 to 85% RH.
- If the ambient temperature exceeds the range indicated above, install a fan or an air conditioner.
- Do not install the unit directly above equipment that generates a lot of heat (heaters, transformers, large capacity resistors, etc.)
- Take the following points into account in order to prevent noise.
    - (1) Avoid installing the unit in panels in which high-voltage equipment is also installed.
    - (2) Install the unit at a distance of at least 200 mm from power lines.
    - (3) If the unit is installed next to equipment that generates a strong electric or magnetic field (solenoids, etc.), provide a gap of at least 40 mm.

- Provide sufficient space for ventilation
- Do not install the unit in locations where it will be subject to strong vibration or severe shock.
- To ensure that the unit can be operated and maintained without difficulty, install it at a distance from high-voltage equipment and power equipment.
- After changing the switch settings, always press the reset switch or turn the power off and back on.  
Otherwise the system will not operate as expected.
- Confirm system safety before turning the power ON/OFF or resetting.  
Otherwise the system may operate unpredictably.
- Check that the current capacity of the equipment to be supplied is within 150 mA before using the +5 V output of pin No.6. The +5 V output of NT620S/NT620C delivers +5 V  $\pm$  5% and 150 mA maximum.  
Do not use the +5 V output of the RS-232C interface unit.

- Press touch switches with a force of no greater than 20 N. Applying higher force may cause glass to break, cause injuries, and prevent operation.
- If touch switches are pressed in rapid succession, their inputs may not be successfully received.  
Confirm that the input of a touch switch has been successfully received before moving on to the next operation.
- Do not press touch switches carelessly while the backlight is off or while nothing is displayed on the screen. Otherwise the system may operate unpredictably.  
Only press touch switches after confirming system safety.
- When the numeral values entered are confirmed, upper/lower limits are checked. Otherwise the system may operate unpredictably.
- Do not disassemble the NT620S/NT620C for repairs or modification. Otherwise, the product may malfunction.
- The disposal of the NT620S/NT620C (and used backlights) may be regulated by national and local authorities. Dispose of them in accordance with the laws and regulations of the relevant country and local authority.
- To ensure system safety, be sure to periodically read the PT operating status bit from the host in order to ensure that the PT is always operating normally.
- Never short the battery terminals, attempt to charge the battery or take it apart, heat it, or discard it into fire. In the worst case, explosion may occur.
- Never short the “+” and “-” terminals of the battery. Do not recharge, take apart, or heat the battery, or discard it into open flame. Attempting any of these will lead to hazards such as fire, leakage of electrolyte, rupture, etc.  
When replacing a battery, ensure that the battery terminal does not touch the board in the NT620S/NT620C.



---

# SECTION 1

## Functions of the NT620S/620C

NT620S/620C is a new programmable terminal (PT) which incorporates a host interface unit and a RS-232C interface unit in a programmable terminal body. It can be easily installed and used.

This section gives the operation examples and characteristics of the NT620S/620C so that you will understand the applications of the NT620S/620C.

1-1	Role and Operation of NT620S/620C .....	2
1-1-1	Operation of an NT620S/620C at an FA Production Site .....	2
1-1-2	Operations of NT620S/620C .....	3
1-2	Functions of NT620S/620C .....	4
1-2-1	Features .....	4
1-2-2	Comparison between NT620S and NT620C .....	5
1-2-3	Principal Functions of NT620S/620C .....	6
1-2-4	Displays .....	7
1-3	System Configuration .....	8
1-4	Communication Using the Direct Connection Function .....	11
1-4-1	Direct Connection Function .....	11
1-4-2	NT Link .....	12
1-4-3	Functions of the Allocated Bits and Words .....	13
1-5	Communication Using the Memory Link .....	17
1-5-1	Memory Link .....	17
1-5-2	Differences with Respect to Direct Connection .....	18
1-6	Before Operating .....	19

## 1-1 Role and Operation of NT620S/620C

NT620S/620C is a programmable terminal used to display and transmit the information in an FA site. The following gives a general description of the role and operation of the NT620S/620C for those who use a programmable terminal (PT) for the first time.

### 1-1-1 Operation of an NT620S/620C at an FA Production Site

#### Production Line Status Monitoring

The NT620S/620C displays real-time information about the system and equipment operating status, etc.

Production Control Chart (3)		Date Time	April 5, 1995 14:15:32
Product	NT20S	NT620S	
Today's target	560 units	441 units	
Current Production	305 units	275 units	
% achieved	54.5 %	63.0 %	
Defective units	2	8	
Repaired units	7	15	

#### Messages

The NT620S/620C warns of system or equipment failures and prompts the appropriate remedial action.

Alarm

Assembly line B

-

Positioning pin

is defective.                      The line has stopped.

Check the following:

1. Pin L3 defective?
2. Position of dog M2
3. Mounting of photosensor P5



**Panel Switch Functions**

Setting touch switches on the NT620S/620C allows workers to use the NT620S/620C as an operating panel. Production data input to the NT620S/620C can be transmitted to a PC.

Electroplating Control							
Transport				Electroplating head	Washing head	Anti-corrosion head	
←		↑	Clamp	UP	UP	UP	
→		↓	Unclamp	DOWN	DOWN	DOWN	
Inter-mediate stop	Forward Reverse	Electro-lyte	Washing water	Anti-corrosive agent	Stop buzzer	Alarm	Reset

**1-1-2 Operations of NT620S/620C**

**Displays Screens**

The information to be displayed (screen data) can be created on a computer by using support tools and stored in the NT620S/620C. The screen data can be displayed on the NT620S/620C in response to the instructions from a PC or touch switch operation.

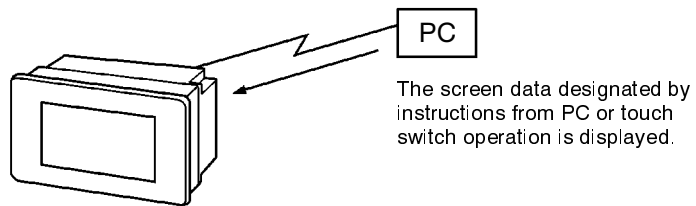

**Receives Data from a PC**

NT620S/620C can be connected to a PC by a host link, NT link or memory link and receive necessary data from the PC.

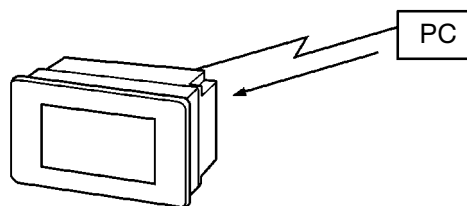

**Sends Data to a PC**

Data input through a touch panel can be sent to a PC.

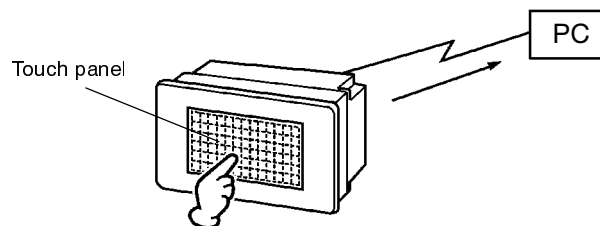

**Screen Data**

The screen data to be displayed on the NT620S/620C can be created by a computer by using support tools. Connect the NT620S/620C to a PC/AT with an RS-232C cable so that the screen data are transferred to the NT620S/620C.

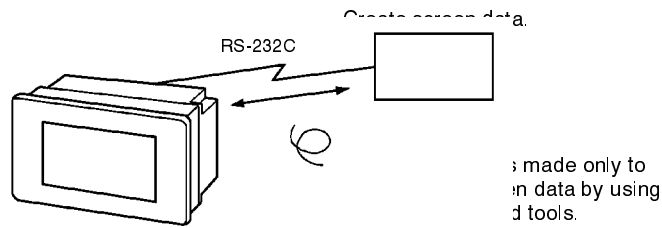

**1-2 Functions of NT620S/620C**

The features and main functions of the NT620S/NT620C are described below.

**1-2-1 Features**

- Construction best suited to the FA environment
  - The NT620S features an amber EL display panel and the NT620C has an STN color LCD panel.
  - Its backlight unit and battery can be replaced at the FA site.
  - Waterproofed to a standard equivalent to IP65 (NEMA4).

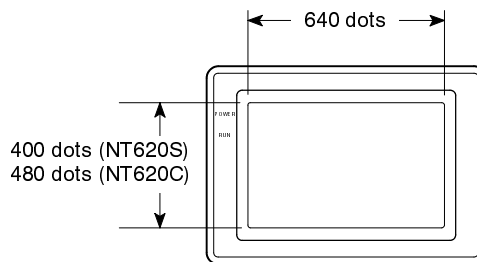

- Easy-to-use system configuration
  - A variety of communication methods including the 1:N connection NT link enable communication with a variety of hosts.
  - All you have to do is connect to the host; no complicated installation work is necessary.
  - A flash memory is used for the screen data memory, making battery backup unnecessary.
- Easy adjustment to system program version upgrades and system configuration changes
  - The system program is installed using the system installer.
  - The following communication methods can be used: host link (direct), NT link, and memory link.

- Touch switch operation

The System Menu can be displayed by using the touch switches located in four corners of the screen.

- Compatibility with NT61□G/610C

Existing screen data, ladder programs, and support tools are compatible.  
(NT61□G ↔ NT620S, NT610C ↔ NT620C)

## 1-2-2 Comparison between NT620S and NT620C

Two NT620 models – the NT620S, which is capable of versatile graphic displays, and the NT620C, which is also capable of color display – are available. The differences between the NT620S and NT620C are tabled below.

Function	NT620S	NT620C
Display panel	Amber EL display type	STN color LCD type (with backlight)
Display size	192 mm horizontally × 120 mm vertically (8.9 in.)	197 mm horizontally × 149 mm vertically (9.4 in.)
Number of display dots	640 dots horizontally × 400 vertically	640 dots horizontally × 480 vertically
Number of touch switches	32 switches horizontally × 16 vertically	32 switches horizontally × 24 vertically
Touch switch size	20 dots horizontally × 25 vertically	20 dots horizontally × 20 vertically
Communication interface	RS-232C connector	
External dimensions (W, H, D)	275 × 192 × 71 mm	275 × 196 × 76.8 mm
Recommended panel cutout size	263.5 mm (width) × 180.5 mm (height)	
Replaceable backlight type	(No backlight)	NT620C-CFL01
Anti-glare sheet type	NT600M-KBA04	NT620C-KBA04
Chemical-resistant cover type	NT600S-KBA01	NT620C-KBA01
Screen data/ladder program compatibility	NT610G/NT612G	NT610C

### 1-2-3 Principal Functions of NT620S/620C

The following are the principal functions of the NT620S/620C:

#### Functions relating to data display

##### Character display

Characters of various sizes can be displayed. Characters can be flashed and highlighted.

##### Figure display

Solid lines, squares, polygons, circles, circular arcs, fan shapes can be displayed. They can also be painted with various patterns, flashed, or highlighted.

##### Memory data display

The contents of character-string memory table and of the numeral table can be displayed. The memory table contents can be changed from the PC.

##### Graph display

Not only bar graphs but also broken line graphs (Note) and trend graphs (Note) can be displayed, using the numeral table.

##### Lamp display

Lamps can be turned on or flashed as controlled by the PC.

##### Alarm list display (Note)

In response to the state of PC contact, warning messages are automatically listed, plus when and how many times the messages appeared can also be displayed.

#### Function relating to data output

##### Buzzer

A built-in buzzer can be sounded.

##### Screen printing

A hardcopy of the screen may be printed onto the printer connected to the NT620S/620C.

#### Functions relating to data input

##### Input by the touch switch

Data can be input by simply touching the screen. There are various touch switch functions such as sending input data to the PC.

##### Pop-up window function

A window overlaying the currently displayed screen can be alternately opened and closed by pressing a touch switch.

In addition to fixed displays, numeric keys and character keys can be set inside the window. Since the window need only be opened when input is required, the screen can be used effectively.

##### Numeric value/character string setting function

Touch switch keys can be assigned numeric values or character strings so that these values and character strings may be input at the operation site or even written onto the numeric/character-string table and sent to the host.

#### Function relating to communication

##### Communications with PC

The NT620S/620C communicates with PC, through various host I/F units or NT link so that data or control commands may be received from PC or information entered from touch switches may be sent to the PC.

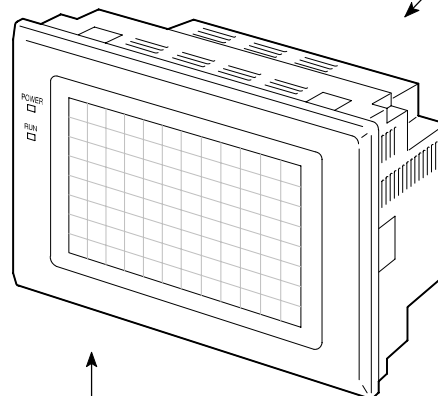

#### Functions relating to the system

##### System functions

System settings and maintenance can be performed by selecting from system menus displayed on the screen.

##### Creation of screen data

Screen data created by using a support tool on a personal computer can be transferred and stored to the image data memory installed to the NT620S/620C.

##### System program installation function

By using the optional system installer, the NT620S/NT620C system program can be changed.

### 1-2-4 Displays

The NT620S/620C can display various kinds of elements such as characters, numeric value, lamps, touch switches, and bar graphs on a screen. The screen data displayed on the NT620S/620C are created by using support tools on a computer.

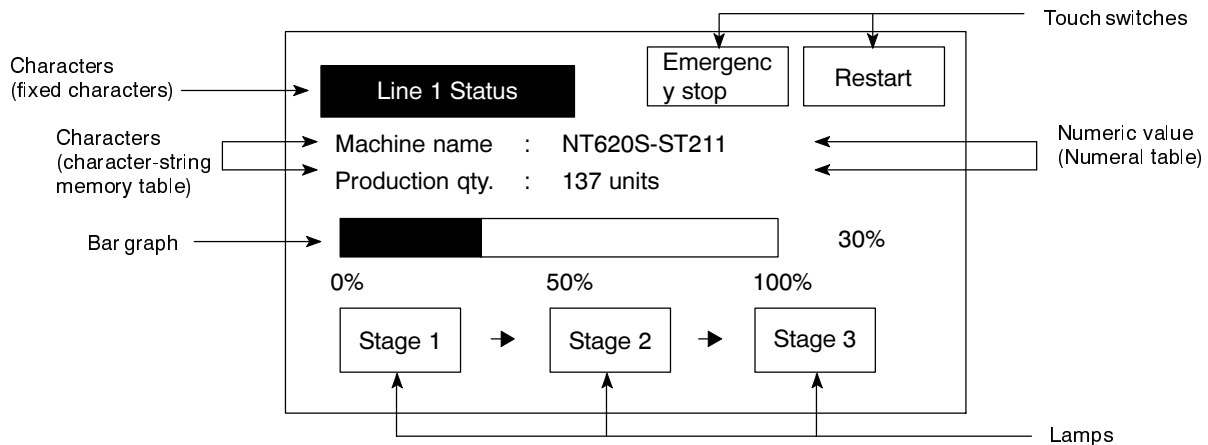

- Characters (fixed characters)
 

Marks and image data which do not need to be changed can be written directly to the screen.
- Characters (character-string memory table)
 

Character-strings stored in the character-string memory table are displayed. The display characters can be changed by changing the data stored in the character-string memory table.
- Numeric Values (numeral memory tables)
 

Numbers stored in the numeral memory table are displayed. The display numbers can be changed by changing the data stored in the numeral table. Hexadecimal values can also be displayed.
- Lamps
 

Lamps indicate the operating status. They are controlled by the PC and can be lit (reversed) or made flash (alternates normal with reversed displays).
- Touch switches
 

These switches can be set at any location on the screen. Pressing the part of the screen where a touch switch has been set can have the following effects: notification of the fact that the switch has been pressed to the PC (PC notification function); screen switching; input of a numerical value or character-string (guide key function input key function); copying of a numerical value or character-string (copy key function); shifting to another numerical value or character-string input field (cursor moving key function); obtaining a hard copy of the screen (screen print key function). Touch switches are controlled from the PC and can be made to light or flash in the same way as lamps.
- Graphs
 

Bar graphs, trend graphs and broken line graphs can be displayed in accordance with numerical values stored in numeral memory tables. These values can also be represented as percentage values displayed together with the graphs.

## 1-3 System Configuration

This section gives the basic configuration of a system which uses an NT620S/620C. Use an RS-232C cable to connect to a PC. Refer to the manual for individual device for information on the equipment other than the NT620S/620C in the system.

---

**Reference**

For details on setting the method and conditions for communication between the NT620S/NT620C and the host, refer to Section 3-5 "Setting the Conditions of Communications with the PC by Using the Memory Switches" (page 72). It is not possible to connect the personal computer used to run the support software and the host at the same time (when using an RS-232C cable).

Representative optional devices available for use with NT620S/NT620C are listed below.

Replacement backlight	NT620C-CFL01 (for NT620C)
Anti-glare sheet	NT600M-KBA04 (for NT620S) NT620C-KBA04 (for NT620C)
Chemical-resistant cover	NT600S-KBA01 (for NT620S) NT620C-KBA01 (for NT620C)
Replacement battery	C500-BAT08

---

Host Link, NT Link (1:1), and Memory Link Systems

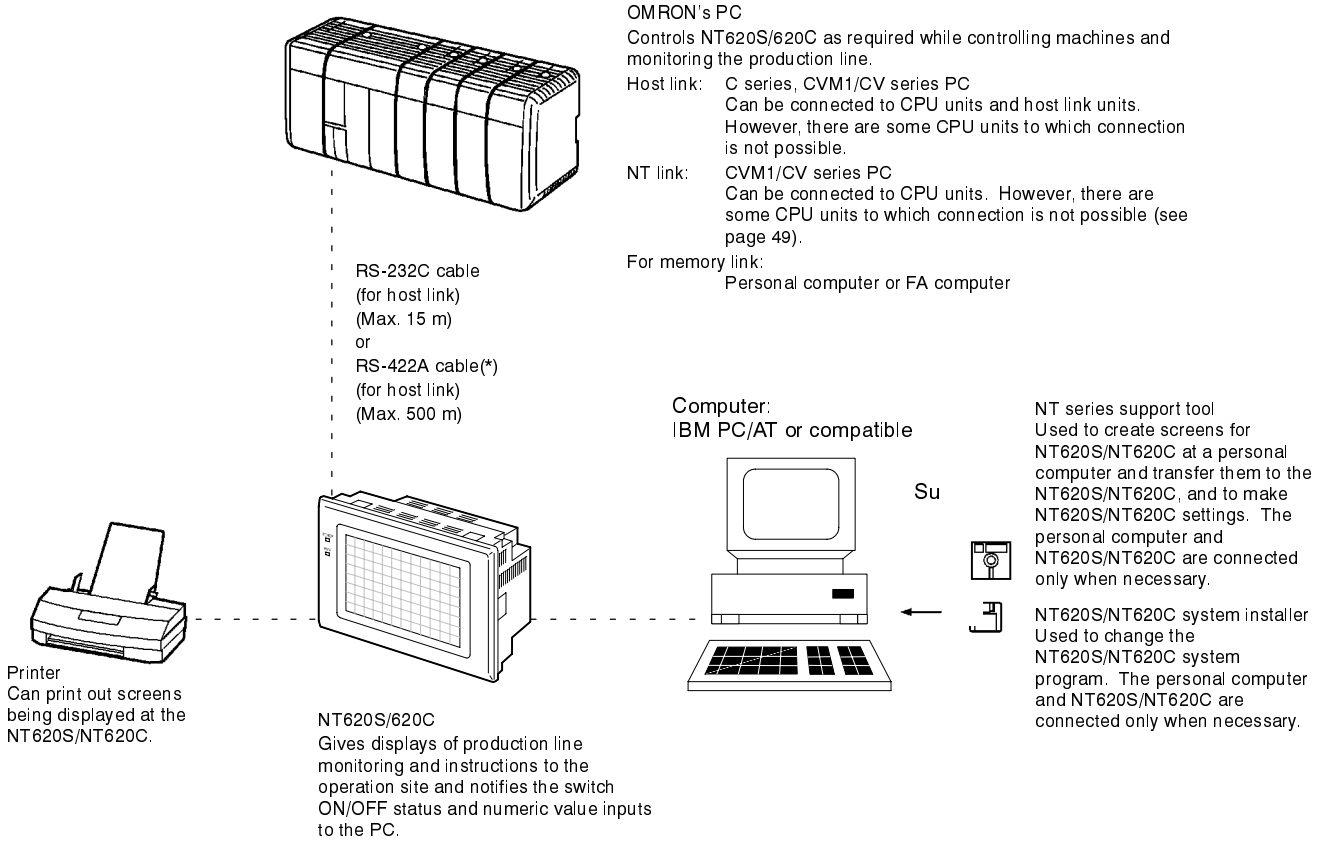

\* When the NT620S/NT620C is used with RS-422A, an RS-232C/RS-422 converter unit (NT-AL001) is required.

Reference

In host link and NT link (1:1) communications, it is possible to connect to RS-422A via an RS-232C/RS-422 converter unit (NT-AL001) but not to RS-485. For details on wiring with RS-422A, see Appendix I "Connecting to an RS-232C/RS-422 Converter Unit" (page 344).

NT Link (1:N) Systems

When NT600S units are connected to a PC in a 1:N connection, use an RS-232C cable and RS-422A/485 cables.

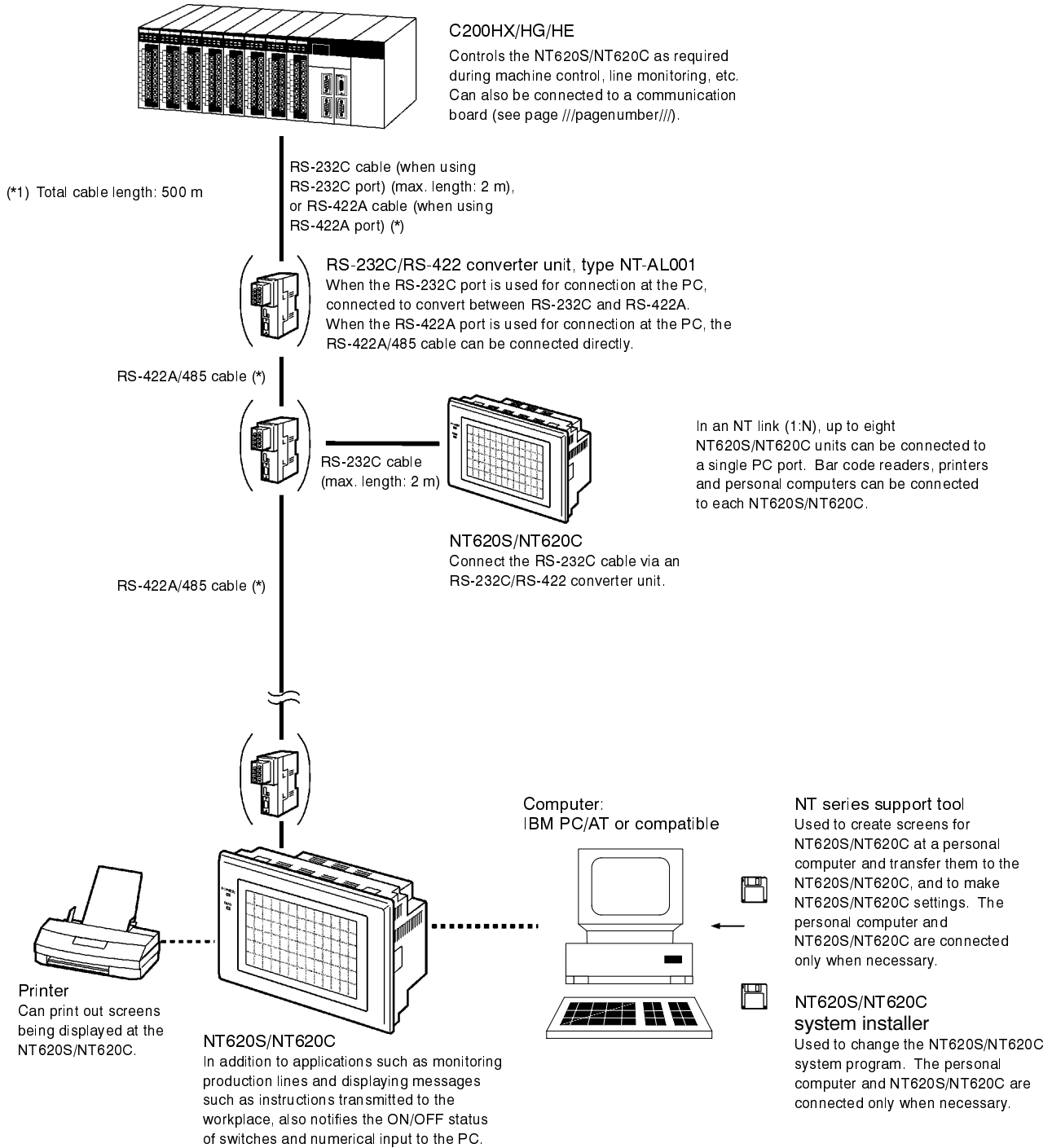



## 1-4 Communication Using the Direct Connection Function

### 1-4-1 Direct Connection Function

The communication method applied between the NT620S/620C and the PC is either a host link or NT link.

The NT620S/620C can be used to refer to the contents necessary for the display information or to allocate the bits and words used for storing the input data to any area in the PC. The NT620S/620C can directly write and read such allocated bits and words so as to change the display elements, control the operating status, and notify the status.

This function is called the “direct connection function”. The NT620S/620C is designed exclusively for use with the direct connection.

The bits and words allocated by the direct connection function are called “allocated bit” and “allocated word” respectively.

This function allows to read the information to be displayed on the NT620S/620C from the memory area in the PC and to write it to the memory table in the NT620S/620C. Also, the data input on the NT620S/620C can be written to the PC’s memory area. The NT620S/620C screen status can be switched according to the PC’s memory area, and the NT620S/620C’s status data can be written to the PC’s memory area.

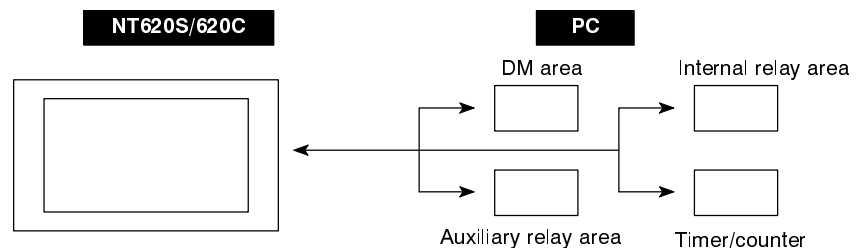

#### Features of the Direct Connection Function

- The bits and words referring to operating status and work instruction information and those for storing input data can be freely allocated to almost any part of the PC memory. Bits and words in the PC can be referenced from any memory table.
- The NT620S/620C can directly refer to PC bit and word data so that it can be connected to a PC without changing the PC program which controls currently running production line.
- The area used for control and notification of NT620S/620C statuses, including displayed screens, whether the screen display is on or off, buzzer output, etc., can be freely allocated to any part of the PC memory.

The direct connection function allows the NT620S/620C to directly read and write almost all bits and words in the PC and to automatically change the NT620S/620C screen display. This function can reduce the load on the PC so that the program development efficiency of the PC improves.

## 1-4-2 NT Link

The NT link is a new communication method applied between the NT620S/620C and a PC.

The PCs that can be connected using the NT link are as follows.

- When using the built-in host link of the CPU unit  
CPM1 (RS-232C adapter required), CQM1, C200HS, C200HX/HG/HE, CVM1/CV series PCs.
- When using a communication board  
C200HX/HG/HE

When using the NT620S/NT620C in an NT link, two communications modes are possible: a single NT620S/NT620C can be connected to one PC (1:1 NT link), or alternatively, up to eight NT620S/NT620C units can be connected to a single PC port (1:N NT link).

However, the 1:N connection NT link can be used with C200HX/HG/HE only. In the following sections, the NT link communication mode in general will be indicated by the term "NT link", a 1:1 connection NT link will be indicated by "NT link (1:1)", and a 1:N connection NT link will be indicated by "NT link (1:N)".

### Features of the NT Link

- High speed communications with specific types of PCs can be executed.
- Writing in units of bits to the PC memory area is possible. (\*)  
This enables another bit of a word data to which a touch switch has been allocated to be used for other purpose (e.g., to allocate a lamp).
- This can be used even when the PC is in the RUN mode.  
When using the host link, the operation mode changes to the monitor mode.
- Provided the PT used is one that supports the NT link (1:N) (i.e., NT30/NT30C/NT20S/NT600S/NT620S/NT620C), up to eight PTs can be connected to a single PC port.
- When using C200HX/HG/HE, by installing an expansion communication board in the option slot of the CPU unit, it is possible to connect up to three NT link (1:N) systems (comprising a total of 24 NT620S/NT620C units). For details on communication boards, refer to the "SYSMAC C200HW-COM01 to 06-E Communication Board OPERATION MANUAL" (W304-E1-□).

(\*) Except a DM area.

The NT link function is compatible with the host link function with respect to screen data. The NT620S/620C screen data and the PC programs handled by the host link direct connection can be used with for the NT link as they are.

### 1-4-3 Functions of the Allocated Bits and Words

Elements displayed on the NT620S/620C and the NT620S/620C status can be allocated to the bits and words of the PC. By changing the contents of the bits and words, the NT620S/620C can be controlled by the PC. It is also possible to send data to the PC by pressing the touch switches on the NT620S/620C.

- Controlling the NT620S/620C by a PC

The following NT620S/620C functions can be controlled by a PC.

- Screens : Display of designated screens, confirmation of screen numbers, etc.
- Memory tables : Writing to a memory table, copying from a memory table to another memory table, etc.
- Lamps and touch switches : Display instructions, confirmation of display status, etc.
- System control : Buzzer ON/OFF, ON/OFF of backlight or EL display, and other NT620S/620C status

- Notifying from the NT620S/620C to a PC

Data in the NT620S/620C is sent to a PC when a touch switch is pressed. The following types of data are sent to a PC.

- NT620S/620C status
- Touch switch status
- Numeric values and character-strings input with numeral/character-string settings by using touch switches.
- Changes in a memory table after copying between memory tables

#### Functions of Display Elements

- Lamps

Allocation destination: Bit

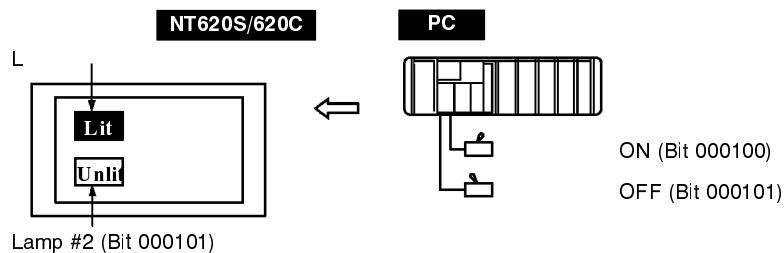

PC's bit status is displayed by the "Lamp" on the NT620S/620C.

The lamp comes on (flashes) when the PC's bit status is ON (1), and goes off when it is OFF (0).

For image and library data, the displayed image or library item can be switched in accordance with the ON (1) or OFF (0) status of a PC bit (lamp bit).

- Touch switches

Allocation destination: Bit

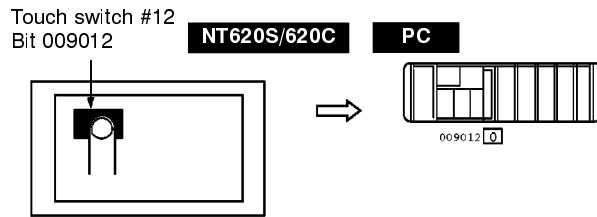

The lamp comes on (flashes) when the PC's control bit is ON (1) and goes off when it is OFF (0). While the touch switch is pressed, the PC's notification bit turns ON (1), and when it is released, the bit turns OFF (0).

- Numeral memory table

Allocation destination: Word

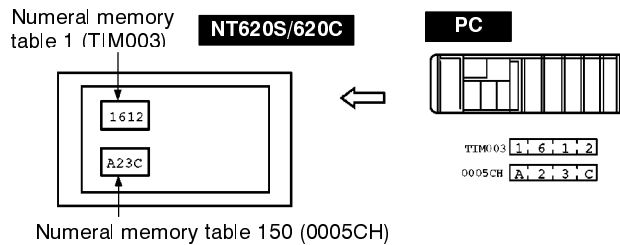

Allocate numeral memory tables to arbitrary words in the PC. If word contents change when corresponding numeral memory table is displayed on the screen, the value on the screen will also change. Monitoring of words can also be made easily.

Reading and writing are executed so that the contents of allocated words are always the same as those of the numeral memory tables.

- Character-string memory table

Allocation destination: Word

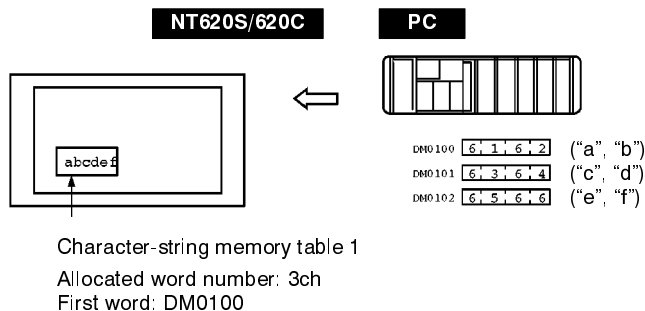

Allocate character-string memory tables to arbitrary words in the PC. If word contents change when corresponding character-string memory table is displayed on the screen, the value on the screen will also change. Messages can be displayed easily.

Reading and writing are executed so that the contents of allocated words are always the same as those of the character-string memory tables.

- Alarm list (bit memory table)
- Allocation destination: Bit

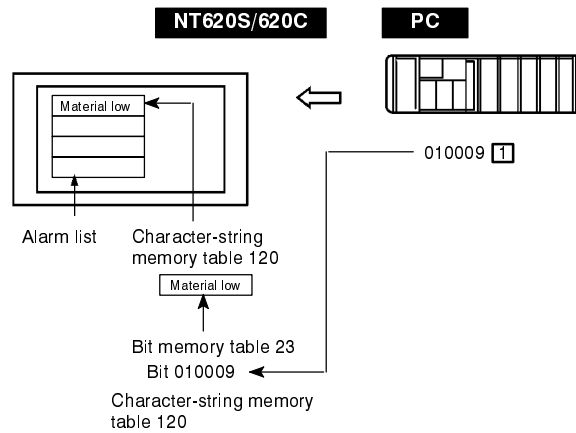

When the PC bit comes ON (1), the contents of the character-string memory table registered for the bit memory table are displayed in the alarm list. When the bit returns to the OFF (0) status, the character-string memory table display is automatically cleared.

**Functions of the PT Status Control Area (PC to NT620S/620C)**

The “PT status control area” is used to control the NT620S/620C status. When data is written to this area in the PC, the NT620S/620C reads the contents and operates according to the contents.

**[Example of the PT status control area application]**

When data is written to the PT status control area, the NT620S/620C will operate as given below.

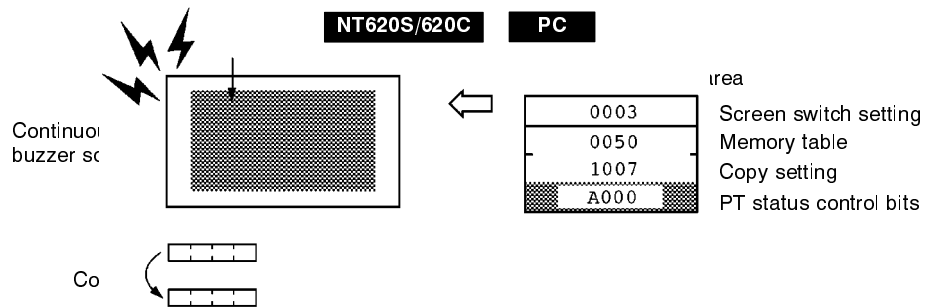

**Functions of the PT Status Notify Area (NT620S/620C to PC)**

The “PT status notify area” is used to notify the changes of the NT620S/620C status.

When a change is made in the NT620S/620C status, the change is written to this area in the PC. By reading the data from the area, the NT620S/620C status can be checked.

**[Example of the PT status notify area application]**

When a change is made in the NT620S/620C status, such change will be notified to the PT status notify area as mentioned below.

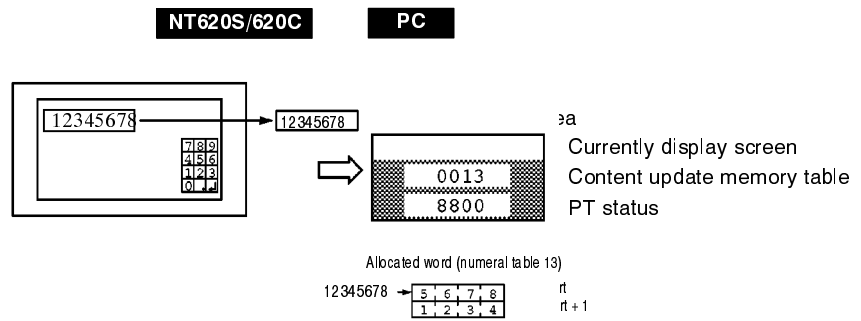

## 1-5 Communication Using the Memory Link

This section describes the “memory link” communication method, which is distinct from memory link in direct connection.

**Reference** Use of the memory link can be enabled by rewriting the system program of the NT620S/NT620C using the system installer.

### 1-5-1 Memory Link

In a memory link, communication with an NT620S/NT620C is executed from a personal computer or FA computer using RS-232C/422A communication.

When memory link is used, the NT620S/NT620C has a memory area called the “PT memory” which is treated as an area within a virtual PC. This means that pseudo-direct connection can take place between the PT memory and the NT620S/NT620C display elements.

By reading from and writing to the PT memory, the host can execute NT620S/NT620C processing via the PT memory.

In addition, dedicated commands are available for reading and writing of frequently used numeral memory tables and character-string memory tables.

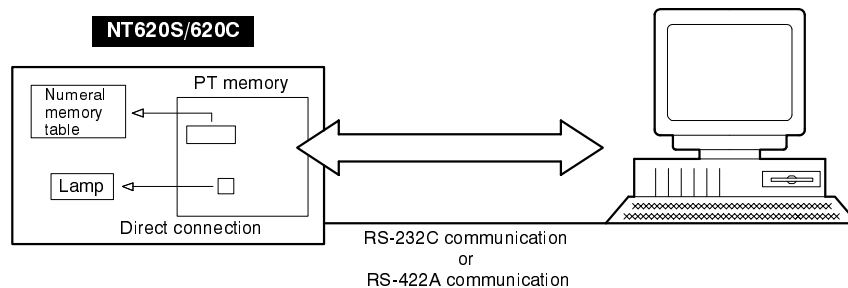

Seen from the perspective of the NT620S/NT620C, when using the memory link method it makes no difference whether the “object” communicated with in direct connection is external or internal, and therefore screen data for direct communication can be used without alteration by merely changing the object of communication.

## **1-5-2 Differences with Respect to Direct Connection**

There are the following two major differences between the memory link method and normal direct connection.

- a) With the memory link method, commands must be used for the final stage of communications with the host. Because of this, in comparison with the direct connection method – which can be used with almost no requirement for a program – the burden on the host is much greater. However, because the memory link method gives unrestricted access to the extensive functions of direct connection from a variety of equipment capable of RS-232C/RS-422A communications – such as personal computers and FA computers – it expands the range of use of the PT.
- b) Since the PT memory is a single area, there is no division into different types of area as there is in the actual areas in a PC; there is only one type of area. In the memory link method, the PT memory is made a virtual I/O relay area. Therefore, even when screen data is created, display elements must always be allocated to the I/O relay area.

For details on communication between the host and NT620S/NT620C using the memory link, see Section 6 “Using Memory Link”, and for details on how to use screens and display elements, and other information, refer to Section 5 “Using Host Link/NT Link”.



# 1-6 Before Operating

Follow the procedure given below to start the system of the NT620S/620C.

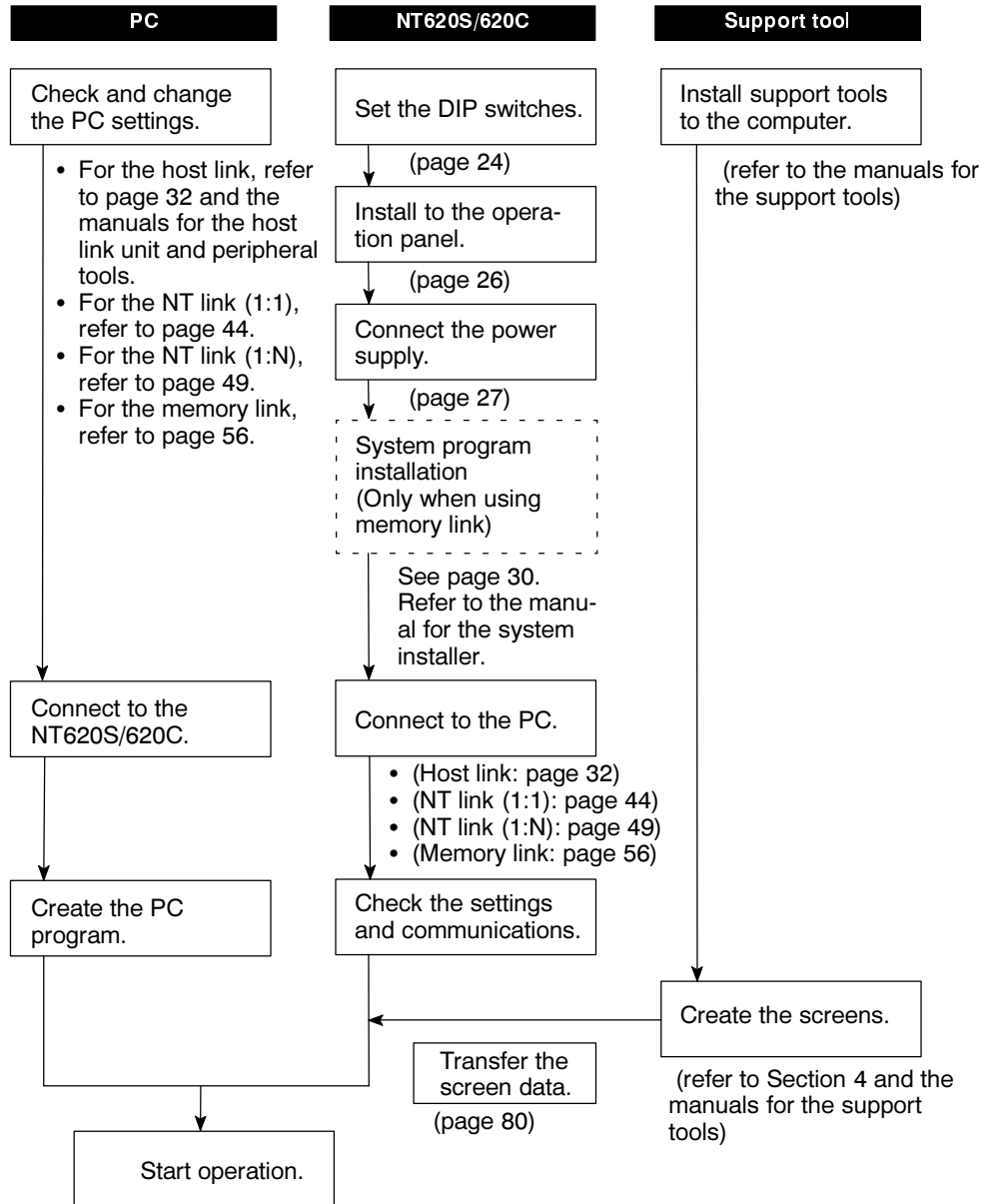

**Reference**

- Use support tool NT Series Support Tool Ver. 2 (type NT-ZA3AT-EV2).
- Use the NT620S/NT620C system installer.

Refer to the following manuals for equipment and software.

Equipment or Software	Manual Title	Manual Number
System installer	NT620S/NT620C system installer/instruction manual	Instruction manual supplied with the product
Support tools	NT series support tool Ver.2.□ Operation Manual	V028-E1-□
PCs	SYSMAC CPM1 Operation Manual	W262-E1-□
	SYSMAC C20H/C28H/C40H/C60H Operation Manual (Programming/RS-232C Interface)	W176-E1-□
	SYSMAC C200H Operation Manual (Programming)	W130-E1-□
	SYSMAC C200HS Installation Guide	W236-E1-□
	SYSMAC C200HS Operation Manual	W235-E1-□
	SYSMAC C200HX/HG/HE Installation Guide	W302-E1-□
	SYSMAC C200HX/HG/HE Operation Manual	W303-E1-□
	SYSMAC C1000H/C2000H Operation Manual (Programming)	W140-E1-□
	SYSMAC CQM1 Programming Manual	W228-E1-□
	SYSMAC CV500/CV1000/CV2000 Operation Manual (Ladder Diagrams) * If using a CVM1 series PC, refer to the SYSMAC CV500/CV1000/CV2000 Operation Manual.	W202-E1-□
Peripheral tools	SYSMAC Support Software Operation Manual (C-series PCs)	W248-E1-□
	SYSMAC Support Software Operation Manual (CVM1 PCs)	W249-E1-□
Host link Unit	SYSMAC C Series Host Link Unit System Manual	W143-E1-□
	SYSMAC CVM1/CV Series Host Link Operation Manual	W205-E1-□

---

## SECTION 2

# Hardware Settings and Connections

This section describes the settings of the NT620S/620C, connections to a PC, and other hardware settings.

2-1	Description of Parts and Settings .....	22
2-1-1	Description of Parts .....	22
2-1-2	DIP Switch Settings .....	24
2-2	Installation .....	25
2-2-1	Installation to the Operation Panel .....	26
2-2-2	Power Supply Connection .....	27
2-2-3	Grounding .....	28
2-3	Connecting to the Support Tool .....	29
2-4	Installing the System Program .....	30
2-5	Connection to a PC by the Host Link .....	32
2-5-1	Compatible PCs .....	32
2-5-2	Connecting the NT620S/620C .....	33
2-5-3	PC Switch Settings .....	35
2-6	Connection to a PC by the NT Link (1:1) .....	44
2-6-1	Compatible PCs .....	44
2-6-2	Connecting the NT620S/620C .....	45
2-6-3	PC Switch Settings .....	46
2-7	Connection to a PC by the NT Link (1:N) .....	49
2-7-1	Compatible PCs .....	49
2-7-2	Connecting the NT620S/NT620C Units .....	49
2-7-3	PC Switch Settings .....	55
2-8	Communication with the Host Using Memory Link .....	56
2-8-1	Connection Method .....	56
2-8-2	Host Settings .....	56
2-9	Connecting a Printer .....	57
2-9-1	How to Connect .....	57

## 2-1 Description of Parts and Settings

Before getting to the operation, confirm the names and functions of parts. Also set the DIP switches on the NT620S/620C.

### Caution

On unpacking the NT620S/NT620C, check its external appearance and confirm that there is no damage. Also confirm that there is no abnormal noise on shaking the NT620S/NT620C lightly.

The product may malfunction if it is damaged.

### 2-1-1 Description of Parts

#### Front View

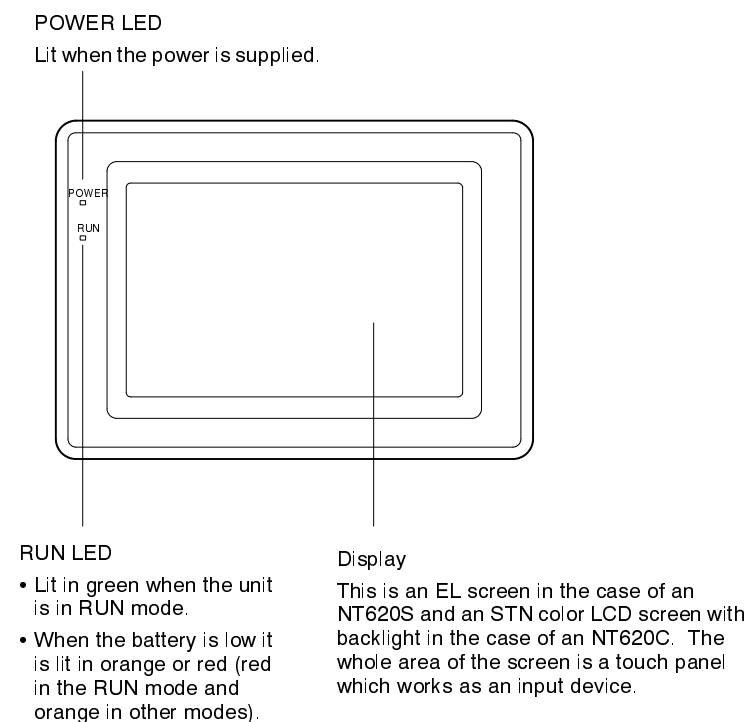

#### Reference

The NT620S/620C comes in two body colors.

NT620S	NT620C	Body Color
NT620S-ST211-E	NT620C-ST141-E	Beige
NT620S-ST211B-E	NT620C-ST141B-E	Black

Rear View

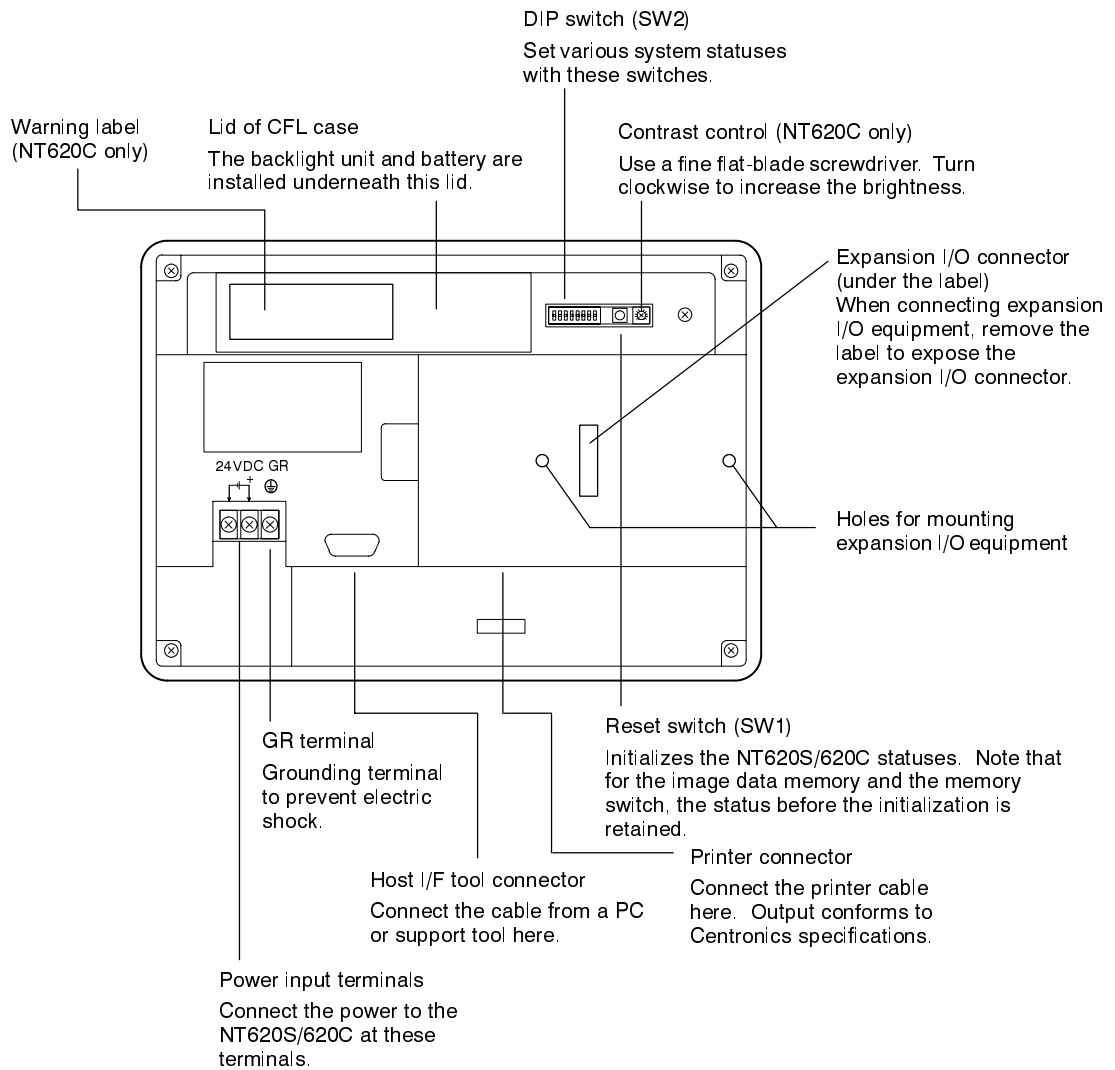

➔ Contrast control is available only for the following models:

- NT620C-ST141-E
- NT620C-ST141B-E

## 2-1-2 DIP Switch Settings

Set the NT620S/620C operation status with the DIP switches located in the bottom right corner on the rear side of the body.

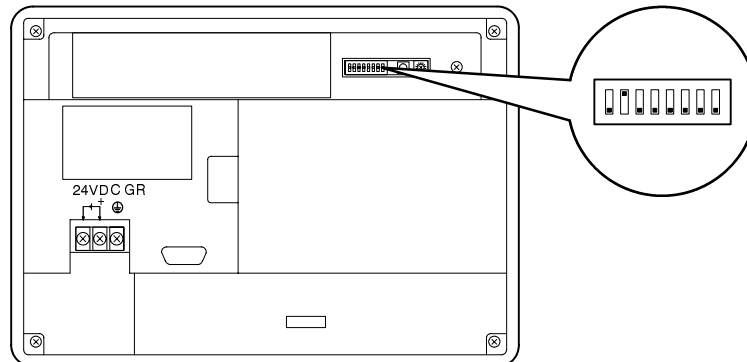

Switch #	Function	
SW2-1	Screen data forced initialize effective/ineffective	
	ON	The NT620S/620C will start in a special RUN mode in which the screen data memory is initialized. When it is started, the memory initialization menu will be displayed. For the initialization procedure, refer to Section 3-4 Initializing Memory (page 65).
	[OFF]	The NT620S/620C will start in normal RUN mode.
SW2-2	System Reserved	
	[ON]	Displays the messages for the installer in English when SW2-8 is ON.
	OFF	Uses Japanese messages.
SW2-3	Switching to the System Menu enabled/disabled	
	ON	The System Menu cannot be displayed. If an error occurs during a start-up, the System Menu will be automatically displayed. However, "RUN Mode" cannot be entered.
	[OFF]	The System Menu can be displayed.
SW2-4	Automatic reset in the event of a communication error	
	ON	When a communication error occurs an error message is displayed and operation stops.
	[OFF]	When a communication error occurs, no error message is displayed and operation continues.
SW2-5 ~ SW2-7	System Reserved	
	ON	
	[OFF]	This switch must be set to the OFF position.
SW2-8	System installation effective/ineffective.	
	ON	System program installation is effective (special mode) at the time when the power turns ON.
	[OFF]	Starts normal RUN mode.

[ ] indicates factory setting.

**⚠ Caution**

- After changing the switch settings, always press the reset switch or turn the power off and back on. Otherwise, the product may malfunction.
- Confirm system safety before turning the power ON/OFF or resetting. Otherwise the system may operate unpredictably.

**Reference**

- In addition to the DIP switches, set also the “Comm. Method”, “Host Link Speed”, etc. at the memory switches. For these settings, refer to Section 3-5 “Setting the Conditions of Communications with the PC by Using the Memory Switches” (page 72).
- The DIP switch settings may have to be changed after the NT620S/NT620C has been installed in an operation panel. Bear this in mind when selecting the installation location in the panel.

## 2-2 Installation

Install the NT620S/620C to the operation panel and connect the power to the NT620S/620C as described below.

### Installation Environment

Observe the following points when installing the NT620S/NT620C in an operation panel.

**⚠ Caution**

- Do not install the NT620S/NT620C at sites subject to the following conditions. Otherwise, the product may malfunction.
  - Severe temperature variations
  - Temperatures or humidities outside the ranges stated in the specifications
  - High humidity, condensation
  - Splashing chemical agents
  - Severe oil splashing
  - Corrosive or flammable gases
  - Strong vibrations or shocks
  - Direct exposure to wind and rain (outdoor sites)
  - Strong ultra-violet irradiation
- Take adequate measures to ensure shielding if the NT620S/NT620C is used at a location subject to any of the following conditions. Otherwise, the product may malfunction.
  - Static electricity, or noise from other equipment
  - Strong electromagnetic fields
  - Nearby power cables
  - Potential exposure to radioactivity

### 2-2-1 Installation to the Operation Panel

The NT620S/620C can be flush mounted to an operation panel.

Use the panel fittings and tools included in the product package and follow the procedure below.

**⚠ Caution**

- During work at the panel, take care to ensure that no metal scraps enter the unit. Otherwise, the product may malfunction.
- The thickness of applicable operation panel is 1.6 mm to 4.8 mm. All fittings must be tightened uniformly to a torque of 0.5 to 0.6 N·m in order to ensure water- and dust-resistance. The panel must not be soiled or warped, and must be able to support an installation that will remain secure and strong.

- (1) Open a hole, shown below, in the panel and install the NT620S/620C from the front side of the panel.

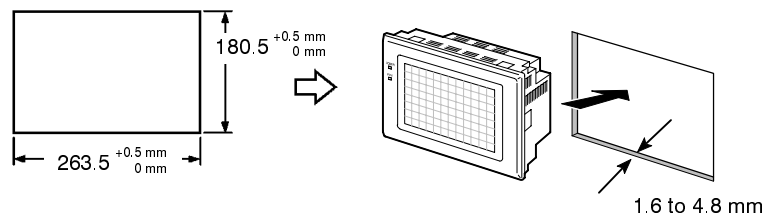

- (2) Attach the panel fittings at four positions for the upper/lower sides and at two positions for the right and left sides, shown below, on the rear side of the NT620S/620C.

Fit the hook of the fitting in the square hole in the body and tighten the screw with a Phillips head screwdriver while lightly pulling the fitting.

If there is no special need for dust- and water-resistance, two fittings indicated by (\*) are not required.

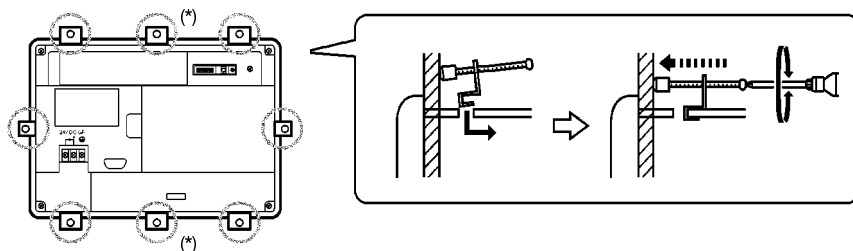



## 2-2-2 Power Supply Connection

Connect a 24 VDC power supply to the power input terminals.

**Note**

- Check the wiring carefully before turning on the power.
- Do not connect an AC power supply to the power supply terminals.
- Use a DC power supply with low voltage fluctuation.
- If complying with EC directives (low voltage directives), observe the following points:
  1. Use a power supply with reinforced insulation to supply power to the PT.
  2. If using the EL display type, embed the rear part of the PT in a control panel so that, after the product has been made ready for installation, the user cannot touch any part of it other than the part where PT operations are performed (the front panel).

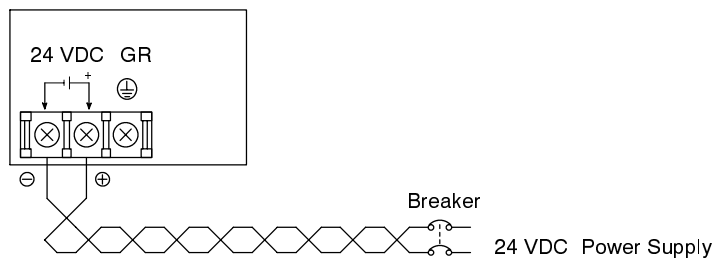

- Power supply

In order to comply with EC directives, use a SELV power supply.

Applicable power supply specifications are as follows.

Item	Value
Power supply voltage	24 VDC
Allowable power supply voltage fluctuation range	20.4 VDC to 26.4 VDC (24 VDC -15%, +10%)
Power supply capacity	20 W or over

**Note**

- Parts used for connection

- For the connection to the power supply terminal block, twisted wires of 0.2 mm<sup>2</sup> or greater cross sectional area and M3.5 size crimp terminals must be used. Tighten the screws on the terminal block to a torque of 0.5 N·m.
- Do not connect wires that are twisted together directly to the power input terminals. This can cause fire and other hazards.

Use the recommended M3.5 size crimp terminals.

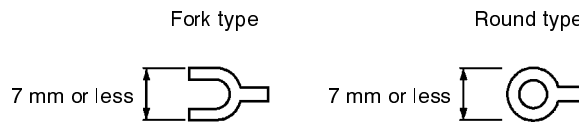

[Recommended terminals]

Maker	Type (fork type)	Type (round type)	Applicable Wire (stranded wire)
Japan Solderless Terminal MFG	2-YS3A	2-3.5	2.0 to 2.63 mm <sup>2</sup>
Fuji Terminal	2-YAS3.5	V2-S3.5	
Nichifu Terminal	2Y-3.5	2-3.5	

### 2-2-3 Grounding

The NT620S/620C has a GR terminal.

The GR terminal is the earth grounding terminal; connect the special grounding wire (2 mm<sup>2</sup> or larger) to this terminal to prevent electric shock. Carry out class 3 grounding (grounding resistance must be less than 100 Ω).

Grounding wire length should be less than 20 m.

Note that if grounding wire is used in common with other equipment, or if it is connected to a beam of a building, for example, the NT620S/620C might be adversely affected by this grounding.

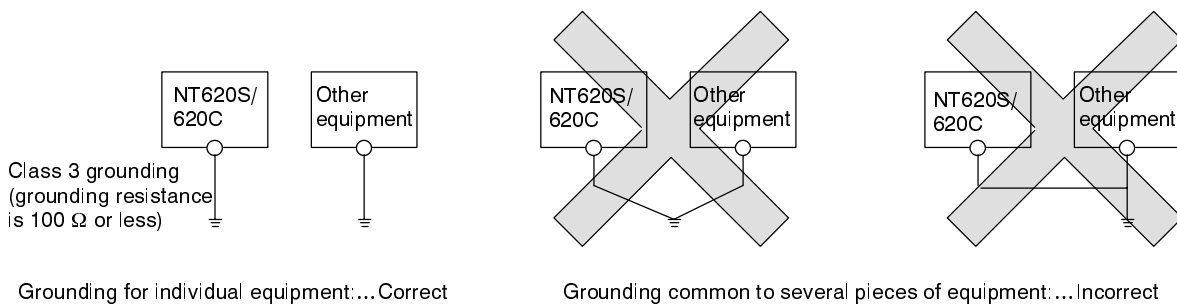

**⚠ Caution**

Carry out grounding correctly in order to prevent misoperation due to noise.

**Note**

Carry out class 3 grounding, connecting the grounding wire to the GR terminal. If grounding is not carried out there will be a danger of electric shock.

## 2-3 Connecting to the Support Tool

Connect the NT620S/620C to a computer with an RS-232C cable to transfer the screen data created by using a support tool to the NT620S/620C.

It is impossible to connect a computer and a PC at the same time to the NT620S/620C. Connect a computer only to transfer the screen data.

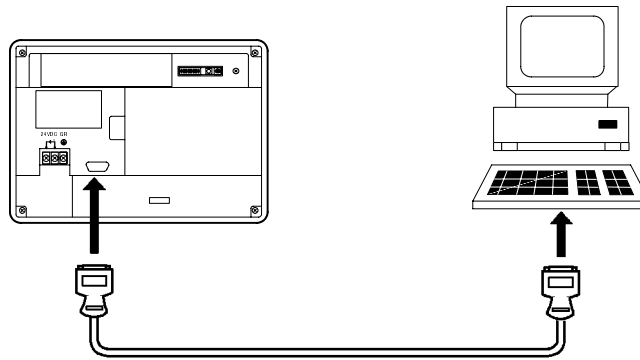

- Communication conditions

Communication conditions are set when a support tool is started.

---

**Reference**

To make a connector cable, refer to Appendix G "Method for Making the Cable for Connection to the PC" (page 332).

---

## 2-4 Installing the System Program

With the NT620S/620C, the system program is not fixed and different programs can be installed. This makes it easy to change the system program when a new version becomes available, or in order to respond to changes in system configuration.

### Reference

When using the memory link, install the system program for the memory link.

The following software is used for system installation.

NT620S/NT620C system installer

Model	Applicable Personal Computer	Communication Method	Remarks
NT-ZS3AT-EV1	IBM PC/AT or compatible	Host link, NT link (1:1)	Installed in the ST□□□-E on shipping.
NT620-ZS3AT-EV1		Host link, NT link (1:1, 1:N)	
NT620-ZS3AT-EMV1	IBM PC/AT or compatible	Memory link	

### Reference

- The system installer differs depending on the communication method used.

A brief description of the method for installing the system program is presented here. For details on the procedure for setting up the system installer in the personal computer and its operation, refer to the manual provided with the system installer.

- Procedure for installing the system program

The procedure for installing the system program in the NT620S/NT620C is presented below.

- (1) Initialization of the NT620S/NT620C

If there is another system program already installed, first delete this program. While the power to the NT620S/NT620C is off, turn DIP switch 2-8 ON, then turn the power to the NT620S/NT620C back on. When the confirmation message is displayed, select "Yes".

- (2) Setting the NT620S/NT620C on standby for installation

Turn the power to the NT620S/NT620C off, and return DIP switch 2-8, whose setting was changed in (1) above, to "OFF". After that, turn the power to the NT620S/NT620C back on.

The NT620S/NT620C will enter the standby status for installation of the system program.

- (3) System program transfer

Connect a personal computer to the NT620S/NT620C, start up the system installer, and transfer the system program to the NT620S/NT620C to install it. For details on the operation involved, refer to the manual provided with the system installer.

- Tool settings of the system installer

In the tool settings of the system installer, specify the type of PT in which the system program is being installed.

Set "NT620S" or "NT620C" for "NT type". Set the other settings in accordance with the environment in which the system installer is to be used.

- Selecting the system program to be transferred

Select the required system program name from the various communication methods displayed in the system program list of the system installer.

For details, refer to the instruction manual provided with the system installer.

## 2-5 Connection to a PC by the Host Link

Connect the NT620S/620C to an OMRON PC by the host link method. To connect the NT620S/620C to a PC by the host link method, the NT620S/620C memory switch for “Comm. Method” must be set for the host link. For the “Comm. Method” setting, refer to “Selecting the Host Communication Method” (page 74).

### 2-5-1 Compatible PCs

Some models and series of OMRON PCs have the host link function built in and some do not. In the C200HX/HG/HE series, there are some CPU models which can be connected by the host link method after adding an expansion communication board.

Check the model and series of the PC against the type of host link unit before making the connections.

The PCs that can be connected to NT620S/NT620C with the RS-232C type host link are indicated below.

PC Series	Units with Built-in Host Link Function		CPU Units Connectable with Expansion Communication Board	Connectable to
	Host Link Unit	CPU Unit		
C series		C20H/C28H/ C40H/C60H		C□□ H
	C120-LK201-V1			C120 C200H C500 (F) C1000H C2000 (H)
	C200H-LK201-V1			C200H
	C200H-LK201-V1	C200HS-CPU21-E C200HS-CPU23-E C200HS-CPU31-E C200HS-CPU33-E		C200HS
	C200H-LK201-V1	C200HE-CPU42-E	C200HE-CPU32-E C200HE-CPU42-E	C200HE
	C200H-LK201-V1	C200HG-CPU43-E C200HG-CPU63-E	C200HG-CPU33-E C200HG-CPU43-E C200HG-CPU53-E C200HG-CPU63-E	C200HG
	C200H-LK201-V1	C200HX-CPU44-E C200HX-CPU64-E	C200HX-CPU34-E C200HX-CPU44-E C200HX-CPU54-E C200HX-CPU64-E	C200HX
C series	C500-LK201-V1 C500-LK203			C500 (F) C1000H (F) C2000 (H)
		CPM1-10CDR-□ CPM1-20CDR-□ CPM1-30CDR-□		CPM1
		CQM1-CPU21-E CQM1-CPU41-E CQM1-CPU42-E CQM1-CPU43-E CQM1-CPU44-E		CQM1

PC Series	Units with Built-in Host Link Function		CPU Units Connectable with Expansion Communication Board	Connectable to
	Host Link Unit	CPU Unit		
CV series (*)	CV500-LK201	CV500-CPU01-EV1		CV500
	CV500-LK201	CV1000-CPU01-EV1		CV1000
	CV500-LK201	CV2000-CPU01-EV1		CV2000
CVM1 series (*)	CV500-LK201	CVM1-CPU01-EV□ CVM1-CPU11-EV□ CVM1-CPU21-EV□		CVM1

\*:Connection to the CPU units of CVM1/CV series PCs whose model names are not suffixed with “-EV□” is not possible. Connect CPU units without the suffix “-EV□” to an NT620S/NT620C by using a host link unit.

### 2-5-2 Connecting the NT620S/620C

Refer to the illustrations below to select the appropriate cable for the unit connectors and connect the NT620S/620C to the PC.

To make a connector cable, refer to Appendix G “Method for Making the Cable for Connection to the PC” (page 332).

**Note**

- Before inserting or removing the connectors, make sure that the NT620S/620C and the PC are turned OFF.

**Caution**

- After connecting the communication cable, be sure to lock the connectors with the screws. Otherwise the cable may disconnect, causing operation to fail.
- The cable’s tensile load is 30 N. Do not subject it to loads greater than this. Otherwise a discontinuity may occur, causing operation to fail.

#### Connecting to a PC with a 25-pin Connector

Use a connector cable with a 25-pin connector on one end and a 9-pin connector on the other end (NT620S/620C side) to connect the NT620S/620C to a PC with a 25-pin connector.

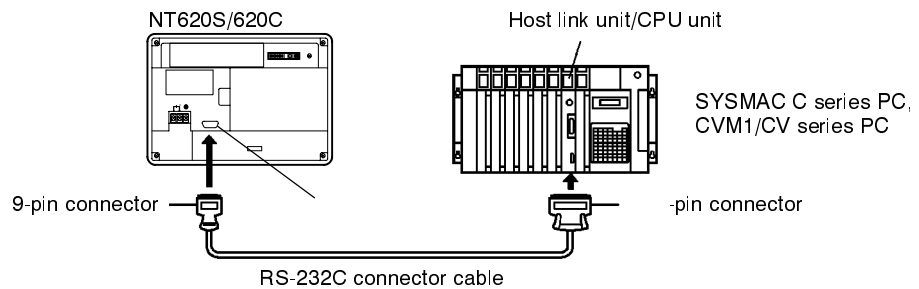

Use the following recommended cables (OMRON);

Connector Specification	Type	Cable Length	Applicable Host Link Unit
25-pin to 9-pin	XW2Z-200S	2 m	C500-LK203 C500-LK201-V1 C120-LK201-V1
	XW2Z-500S	5 m	C200H-LK201(-V1) CV500-LK201

**Connecting to a PC with a 9-pin Connector**

Use a connector cable with a 9-pin connector on both ends to connect the NT620S/620C to a PC with a 9-pin connector.

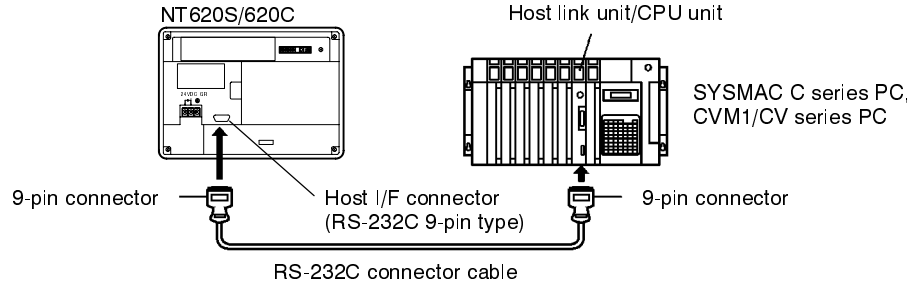

The connector cable wiring for the C series CPU unit (C□□H) is different from that for the other PCs. For details, refer to Appendix G “Method for Making the Cable for Connection to the PC” (page 332).

**Connecting the NT620S/620C to a CVM1/CV Series Host Link Unit**

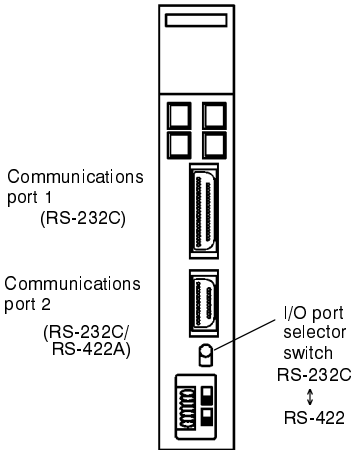

Two types of connectors are provided to CV500-LK201 host link unit. Both of these connector types can connect to the NT620S/620C with an RS-232C connector cable. Select the connector cable which matches the connector type.

- To connect to communication port 1  
This is a 25-pin RS-232C connector. Use a connector cable with a 25-pin connector on one end and a 9-pin connector on the other end (NT620S/620C side).
- To connect to communication port 2  
This is a 9-pin RS-232C/RS-422 connector. Use a connector cable with a 9-pin connector on both ends.  
Set the I/O port selector switch to the RS-232C side (upper side) to use this port.

**Connecting the NT620S/620C to a C Series CQM1 Unit**

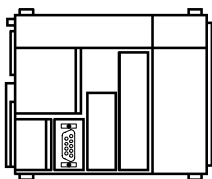

CQM1 can connect to the NT620S/620C by the RS-232C method. Use an RS-232C 9-pin type connector cable.

- To connect to the RS-232C port  
This is a 9-pin RS-232C connector. Use a connector cable with a 9-pin connector on both ends.

**Connecting to C Series C200HX/HG/HE**

When using C series C200HX/HG/HE models, the NT620S/NT620C can be connected to the standard port of the CPU unit, or to ports A and B of the expansion communication board.

Procure an RS-232C 9-pin type connection cable for the connection. For details on the specifications, installation method, etc., of the communication board used for the connection, refer to the “SYSMAC C200HX/HG/HE Installation Guide” (W302-E1-1).



**Connecting to C Series CPM1**

The CPM1 is connected via an RS-232C adapter (type CPM1-CIF01). Procure an RS-232C 9-pin type connection cable for the connection.

**When a connector cable of 5 m or longer is required**

When a connector cable of 5 m or longer is required, please make the cable. However, note that the maximum transmission distance is 15 m.

To make a connector cable, refer to Appendix G “Method for Making the Cable for Connection to the PC” (page 332).

**When Long-Distance Transmission is Required**

When transmission over a distance exceeding the RS-232C specification is required, it can be achieved by using an RS-232C/RS-422A converter unit (type NT-AL001) to switch to RS-422A communication (RS-485 communication cannot be used).

For details, refer to Appendix I “Connecting to an RS-232C/RS-422 Converter Unit” (page 344 of the appendix).

**2-5-3 PC Switch Settings**

When the NT620S/620C and PC are connected to each other, set the conditions at the PC host link unit or the CPU as given in the table below.

The following is a general description of switch settings.

Refer to the manual for respective units for the details of the switch settings.

Item	Switch Setting
I/O port	RS-232C
Baud rate	Set the same baud rate as the NT620S. (*1)
Transfer code	ASCII 7 data bits, 2 stop bits
Parity	Even
1-to-1/1-to-N	1-to-N (*2)
Instruction level	Level 1, 2, 3
Unit #	00

- Note**
- \*1. Set the host link baud rate at 9600 bps or 19200 bps with the memory switch for “host link baud rate”. For the details, refer to “Selecting the Host Link Communication Speed” (page 76).
  - \*2. The 1-to-N setting enables BCC (Block Check Character). The 1-to-N connection cannot be used to connect the NT620S/620C to one host link unit.

---

**Correct use** When using CVM1/CV series, always set “CPU execution processing (execution control 2)” in the PC system settings to “simultaneous processing”.

---

**Connecting to a Host Link Unit**

Two types of host link units are available: a rack-mounting type and a CPU-mounted type. The switch settings differ according to the type of host link unit. Set the switches according to the unit type.

- C200H rack-mounting type: C200H-LK201 (-V1)

**[Setting the front switches]**

Set each switch with a flat blade screwdriver so that the values or symbols in the setting value window agree with the following.

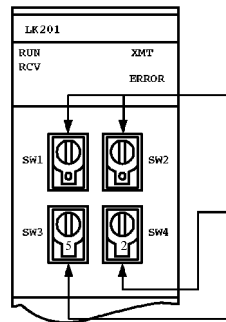

- Unit # (SW1, SW2)  
Set these switches to "0".
- Instruction level, parity, and transfer code (SW4)  
Set this switch to "2".
- Baud rate (SW3)  
Set this switch to "5" to select 9600 bps.  
Set this switch to "6" to select 19200 bps.

**[Setting the rear switches]**

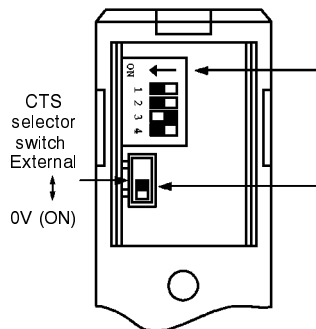

- 1-to-1/1-to-N selection (DIP switch)  
Set #3 to "ON".
- CTS selection (selector switch)  
Set this always to "0V" (ON).

- C500F/C1000HF/C2000 (H) rack-mounting type: C500-LK201-V1

**[Setting the front switches]**

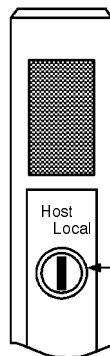

- Mode control (key switch)  
Set this to "host link".

[Setting the rear switches]

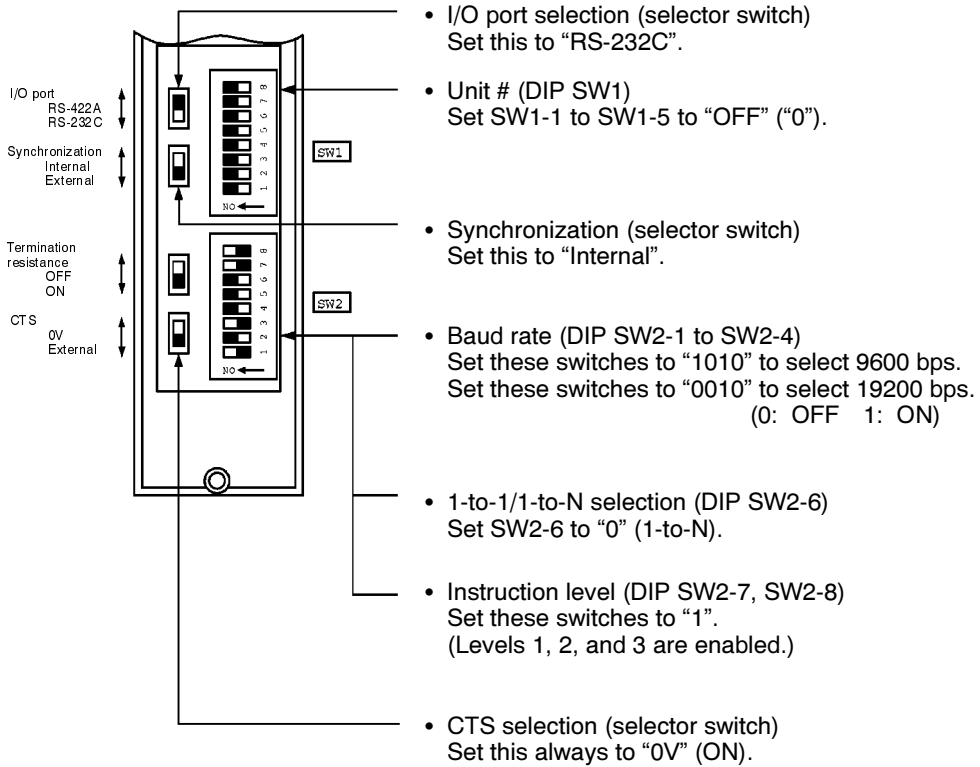

- C500/C1000H/C2000H rack-mounting type: C500-LK203

**[Setting the rear switches]**

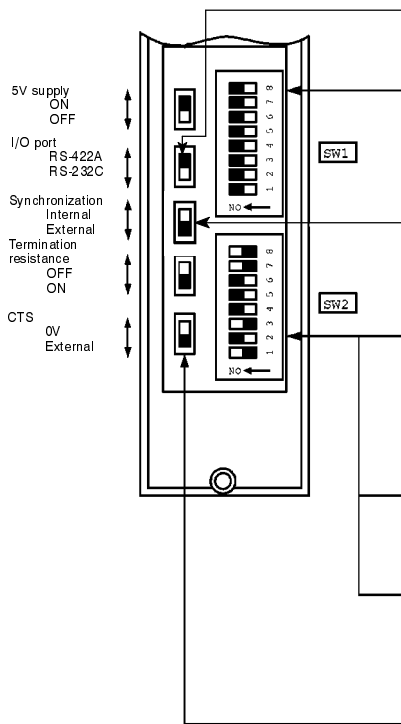

- I/O port selection (selector switch)  
Set this to "RS-232C".
- Unit#, parity, and transfer code (DIP SW1-1 to SW1-7)  
Set SW1-1 to SW1-7 to "OFF" ("0").
- Synchronization (selector switch)  
Set this to "Internal".
- Baud rate (DIP SW2-1 to SW2-4)  
Set these switches to "1010" to select 9600 bps.  
Set these switches to "0010" to select 19200 bps.  
(0: OFF 1: ON)
- 1-to-1/1-to-N selection (DIP SW2-6)  
Set SW2-6 to "0" (1-to-N).
- Instruction level (DIP SW2-7, SW2-8)  
Set these switches to "1".  
(Levels 1, 2, and 3 are enabled.)
- CTS selection (selector switch)  
Set this always to "0V" (ON).

- CPU-mounted type: C120-LK201-V1

**[Setting the rear switches]**

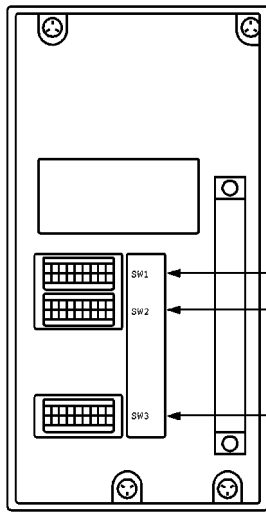

- Unit#, parity, and transfer code (DIP SW1-1 to SW1-5)  
Set SW1-1 to SW1-5 to "OFF" ("0").  
\* Parity is fixed at Even Parity. Transfer code is fixed at ASCII 7 data bits and 2 stop bits.
- Baud rate (DIP SW2-1 to SW2-4)  
Set these switches to "1010" to select 9600 bps.  
Set these switches to "0010" to select 19200 bps.  
(0: OFF 1: ON)
- 1-to-1/1-to-N selection (DIP SW2-6)  
Set SW2-6 to "0" (1-to-N).
- Instruction level (DIP SW2-7, SW2-8)  
Set these switches to "1".  
(Levels 1, 2, and 3 are enabled.)
- CTS selection (DIP SW3-1 and SW3-2)  
Set SW3-1 to "ON" (1) and SW3-2 to "OFF" (0). (Set this always to "0V".)
- Synchronization (DIP SW3-3 to SW3-6)  
Set SW3-3, SW3-5, and SW3-6 to "ON" (1), and SW3-4 to "OFF" (0). (Set these to "Internal".)

- CVM1/CV series backplate mounted type: CV500-LK201

**[Setting the front switches]**

Set the operating conditions with the PC System Setting functions when a CVM1/CV series host link unit is connected to the NT620S/620C. The PC system settings can be made directly from the peripheral tool (LSS etc.) or the PC system setting information created with a peripheral tool can be transferred to the CPU.

The following describes the switch settings so as to enable the PC system settings. For the details of the PC system settings, refer to the “SYSMAC CVM1/CV Series Support Software Operation Manual (Details)” (W196-E1).

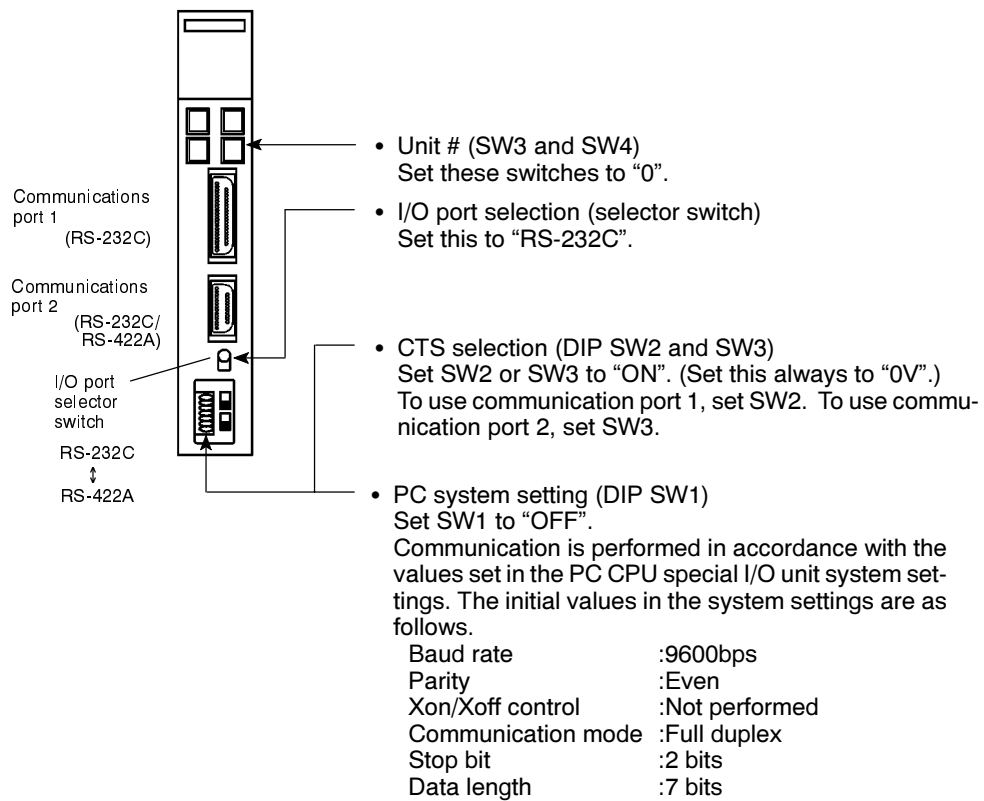

Connecting to a CPU

- C-series C□□H, CVM1/CV-series (-EV1)

Set the operating conditions with the PC System Setting functions when a C □□ H, CVM1/CV-series host link unit is connected to the NT620S/620C. The PC system settings can be made directly from the peripheral tool (LSS etc.) or the PC system setting information created with a peripheral tool can be transferred to the CPU.

The following describes the switch settings so as to enable the PC system settings. For the details of the PC system settings, refer to the "SYSMAC C□□H User's Manual (Programming)" (W176-E1) and the "SYSMAC CVM/CV-Series Support Software Operation Manual (Details)" (W196-E1).

- (1) C-series C□□H : C20H/C28H/C40H/C60H

No switch settings are required when connecting to a C-series C□□H CPU.

- (2) CVM1/CV-series : CV500-CPU01-EV1  
CV1000-CPU01-EV1  
CV2000-CPU01-EV1  
CVM1-CPU01-EV□  
CVM1-CPU11-EV□  
CVM1-CPU21-EV□

Only the CVM1/CV-series CPUs of the "-EV1" or later version can be connected to the NT620S/620C.

When connecting to a CVM1/CV-series CPU, set the switches as given below.

[Setting the front switches]

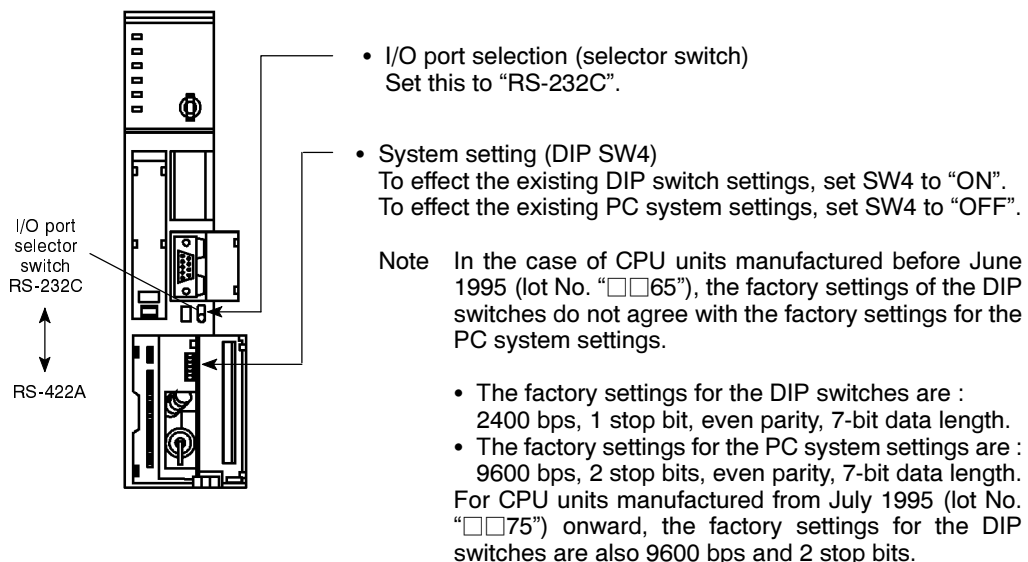

**[Making the PC system settings]**

The possible settings and existing settings which can be set by the PC system setting are as given below.

Item	Possible Setting	Existing Setting
Baud rate	1200/2400/4800/9600/19200 bps	9600/19200 bps
Stop bit	1 or 2 stop bits	2 stop bits
Parity	Even/odd/non-parity	Even parity
Data length	ASCII 7 bits	ASCII 7 bits
Unit #	00 to 31	Unit #00

- C-series C200HS, C200HX/HG/HE, CPM1, CQM1

When connecting an NT620S/NT620C and a C200HS, C200HX/HG/HE, CPM1, or CQM1 CPU unit, set the communication conditions in the PC system setting area. Write the settings directly from the peripheral tool (e.g. SYSMAC support tool) to the PC system setting area (data memory).

The switch settings made to enable “PC system setting” are described here. For details on PC system setting area operations, refer to the manual for the PC you are using (page 20).

**[Switch settings] (C200HX/HG/HE, CQM1)**

CPU unit DIP switch settings



RS-232C port communication condition settings  
Set DIP switch 5 to OFF (right side) to enable the PC system settings.

**[Switch settings] (CPM1)**

Set the mode setting switch to the “HOST” (upper) position.

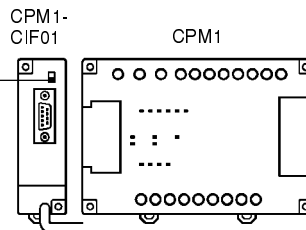



**[PC system setting area settings]**

Write settings to the PC system setting area (data memory) according to the port used to connect to the NT620S/620C.

- When using the RS-232C port of a C200HX/HG/HE

Channel #	Writing Value	Settings
DM6645	0001	Host link mode and conditions are set.
DM6646	0303	Data length: 7 bits, 2 stop bits, even parity, baud rate: 9600 bps
	0304	Data length: 7 bits, 2 stop bits, even parity, baud rate: 19200 bps
DM6648	0000	Unit # 0

- When using port A of C200HX/HG/HE

Channel #	Writing Value	Settings
DM6555	0001	Host link mode Set the conditions with the contents of DM.
DM6556	0303	Data length: 7 bits, 2 stop bits, even parity, baud rate: 9600 bps
DM6558	0000	Unit No. 0

- When using port B of C200HX/HG/HE

Channel #	Writing Value	Settings
DM6550	0001	Host link mode Set the conditions with the contents of DM.
DM6551	0304	Data length: 7 bits, 2 stop bits, even parity, baud rate: 19200 bps
DM6553	0000	Unit No. 0

- When using CPM1

Channel #	Writing Value	Settings
DM6650	0001	Host link mode Set the conditions with the contents of DM.
DM6651	0304	Data length: 7 bits, 2 stop bits, even parity, baud rate: 19200 bps
DM6653	0000	Unit No. 0

## 2-6 Connection to a PC by the NT Link (1:1)

Connect the NT620S/NT620C to an OMRON PC in a 1:1 connection by the NT link method.

To do this, the following settings must be made:

NT620S/NT620C      “Comm. Method” memory switch:NT Link

For details on setting the “Comm. Method” memory switch, refer to “Selecting the Host Communication Method” (page 74) and for details on setting the DIP switches, refer to “DIP Switch Settings” (page 24).

### 2-6-1 Compatible PCs

Some models and series of OMRON PCs have the NT Link function built in and some do not. In the C200HX/HG/HE series, there are some CPU models which can be connected by the NT link method after adding an expansion communication board.

Check the model and series of the PC against the type of NT link unit before making the connections.

The PCs that can be connected to NT620S/NT620C are indicated below.

PC Series	CPU Unit	CPU Units Connectable with Expansion Communication Board	Connectable to
C series	CPM1-10CDR-□ CPM1-20CDR-□ CPM1-30CDR-□		CPM1
	CQM1-CPU41-E CQM1-CPU42-E CQM1-CPU43-E CQM1-CPU44-E		CQM1
	C200HS-CPU21-E C200HS-CPU23-E C200HS-CPU31-E C200HS-CPU33-E		C200HS
	C200HE-CPU42-E	C200HE-CPU32-E C200HE-CPU42-E	C200HE
	C200HG-CPU43-E C200HG-CPU63-E	C200HG-CPU33-E C200HG-CPU43-E C200HG-CPU53-E C200HG-CPU63-E	C200HG
	C200HX-CPU44-E C200HX-CPU64-E	C200HX-CPU34-E C200HX-CPU44-E C200HX-CPU54-E C200HX-CPU64-E	C200HX
CV series	CV500-CPU01-EV1		CV500
	CV1000-CPU01-EV1		CV1000
	CV2000-CPU01-EV1		CV2000
CVM1 series	CVM1-CPU01-EV□ CVM1-CPU11-EV□ CVM1-CPU21-EV□		CVM1

## 2-6-2 Connecting the NT620S/620C

Refer to the illustrations below to select the appropriate cable for the unit connectors and connect the NT620S/620C to the PC.

A host link connector cable can also be used. To make a connector cable, refer to Appendix G “Method for Making the Cable for Connection to the PC” (page 332).



**Caution**

Before inserting or removing the connectors, make sure that the NT620S/620C and the PC are turned OFF.

### RS-232C Cable

Use a connector cable with a 9-pin connector on both ends to connect the NT620S/620C to a PC with a 9-pin connector.

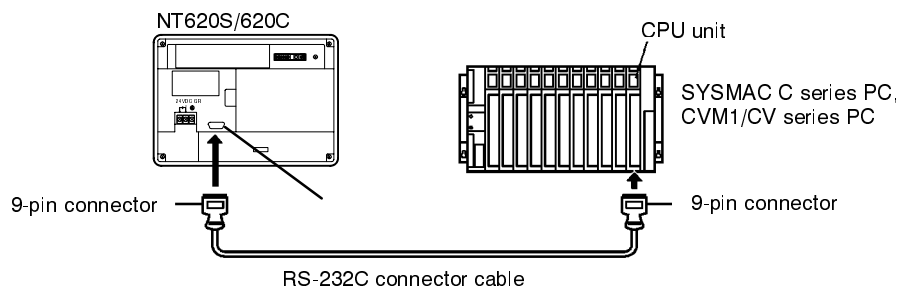

The following are the recommended cables.

Connector Specification	Model	Cable Length
9-pin to 9-pin	XW2Z-200T	2 m
	XW2Z-500T	5 m



**Caution**

- After connecting the communication cable, be sure to lock the connectors with the screws. Otherwise the cable may disconnect, causing operation to fail.
- The cable’s tensile load is 30 N. Do not subject it to loads greater than this. Otherwise a discontinuity may occur, causing operation to fail.

### If a Cable Longer Than 5 m is Required

If a cable longer than 5 m is required, a connector cable will have to be made. Refer to Appendix E “Method for Making the Cable for Connection to the PC” (page 332).

The maximum transmission distance is 15 m.

### When Long-Distance Transmission is Required

When transmission over a distance exceeding the RS-232C specification is required, it can be achieved by using an RS-232C/RS-422A converter unit (type NT-AL001) to switch to RS-422A communication (RS-485 communication cannot be used).

For details, refer to Appendix I “Connecting to an RS-232C/RS-422 Converter Unit” (page 344 of the appendix).

### 2-6-3 PC Switch Settings

When the NT620S/620C and PC are connected to each other, set the conditions at the PC CPU so as to enable the NT link communications.

The settings at the PC are the same regardless of whether the connection at the NT620S/NT620C is an RS-232C type or RS-422A type. The following is a brief description of the setting method.

- C-series C200HS, C200HX/HG/HE, CPM1, CQM1

When connecting an NT620S/NT620C and a C200HS, C200HX/HG/HE, CPM1, or CQM1 CPU unit, set the communication conditions in the PC system setting area. Write the settings directly from the peripheral tool (e.g. SYSMAC support tool) to the PC system setting area (data memory).

The switch settings made to enable “PC system setting” are described here. For details on PC system setting area operations, refer to the manual for the PC you are using (page 20).

#### [Switch settings] (C200HX/HG/HE, CQM1)

DIP switch settings

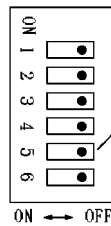

RS-232C port communication condition settings  
Set DIP switch 5 to OFF (right side) to enable the PC system settings.

#### [PC system setting area settings] (C200HX/HG/HE, CPM1, CQM1)

In accordance with the CPU unit and port used for connection to the NT620S/NT620C, write the appropriate numerical value to the PC system setting area (data memory).

PC side	Channel #	Writing Value	Settings
RS-232C port of C200HX/HG/HE, CQM1	DM6645	4000	NT link (1:1) is used.
Port A of C200HX/HG/HE	DM6655		
Port B of C200HX/HG/HE	DM6550		
CPM1	DM6650		

- CVM1/CV-series (-EV□)

When connecting to a CVM1/CV-series (-EV□) CPU, set the switches as given below.

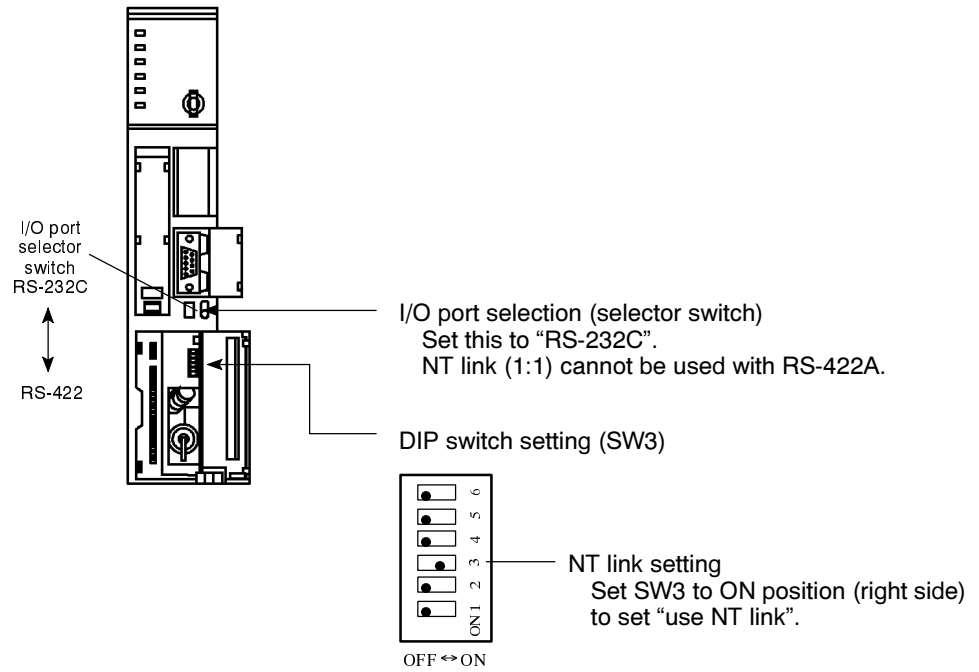

---

**Correct use** When using CVM1/CV series, always set "CPU execution processing (execution control 2)" in the PC system settings to "simultaneous processing".

---

- RS-232C/RS-422 converter unit (NT-AL001)

When an NT620S/NT620C is connected in an RS-422A type 1:1 connection, set the DIP switches of the RS-232C/RS-422A converter unit (NT-AL001) used as a relay as follows.

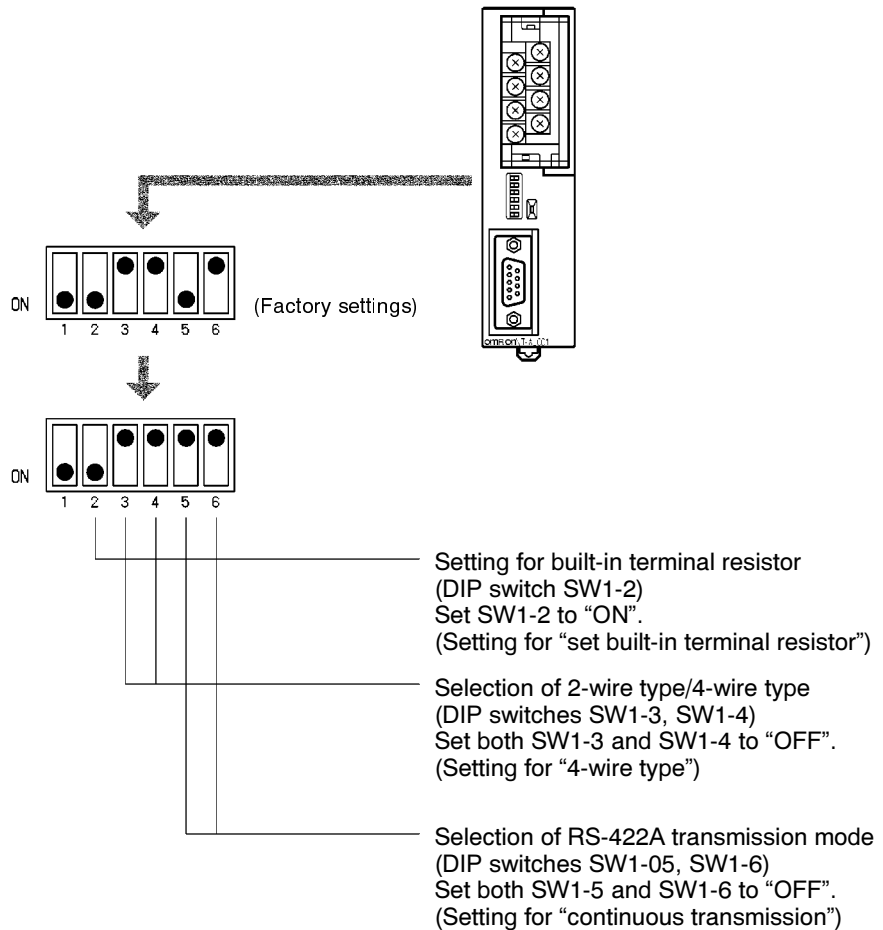

## 2-7 Connection to a PC by the NT Link (1:N)

Connect NT620S/NT620C units to an OMRON PC in a 1:N connection by using the NT link method.

To do this, the communication conditions must be set with the memory switches.

- Setting NT link (1:N)  
(Refer to “Setting the Host Communication Method” (page 74))
- Setting the unit No. of the connected NT620S/NT620C  
(Setting Unit Numbers (NT Link 1:N Only) (page 77))

With NT link (1:N), both RS-422A type (4-wire) and RS-485 type (2-wire) connections are possible. The NT link (1:N) cannot be used with the system programs installed in NT620S-ST211(B) and NT620C-ST141(B) on shipment. The system program must be changed by using the NT620-ZS3AT-EMV system installer.

### 2-7-1 Compatible PCs

The only OMRON PCs that can be connected in an NT link (1:N) are the C series C200HX/HG/HE models.

When making a connection, check the series and model of the PC to which the connection is being made, and the type of CPU unit that is installed. The following is a list of the PCs that can be connected to the NT620S/NT620C via an NT link (1:N).

PC Series	CPU Unit with Built-in NT Link Function	CPU Units Connectable Using an Expansion Communication Board	Connectable to
C series	C200HE-CPU42-E	C200HE-CPU32-E C200HE-CPU42-E	C200HE
	C200HG-CPU43-E C200HG-CPU63-E	C200HG-CPU33-E C200HG-CPU43-E C200HG-CPU53-E C200HG-CPU63-E	C200HG
	C200HX-CPU44-E C200HX-CPU64-E	C200HX-CPU34-E C200HX-CPU44-E C200HX-CPU54-E C200HX-CPU64-E	C200HX

### 2-7-2 Connecting the NT620S/NT620C Units

Referring to the illustrations below and using a cable appropriate for the CPU unit’s connector, connect the NT620S/NT620C units and the PC using RS-232C/RS-422 converter units (type NT-AL011).

A host link connection cable can be used as the RS-232C cable. For details on making a connection cable, refer to Appendix G “Method for Making the Cable for Connection to the PC” (page 332 of the appendix).



**Caution**

- After connecting the communication cable, be sure to lock the connectors with the screws. Otherwise the cable may disconnect, causing operation to fail.
- The cable’s tensile load is 30 N. Do not subject it to loads greater than this. Otherwise a discontinuity may occur, causing operation to fail.

**Reference**

Read the instruction manual provided with the NT-AL001 carefully.

Connection Diagram

As shown in the figure below, connect multiple NT620S/NT620C units to one PC via RS-232C/RS-422 converter units. In an NT link (1:N), up to eight NT620S/NT620C units can be connected to one PC port.

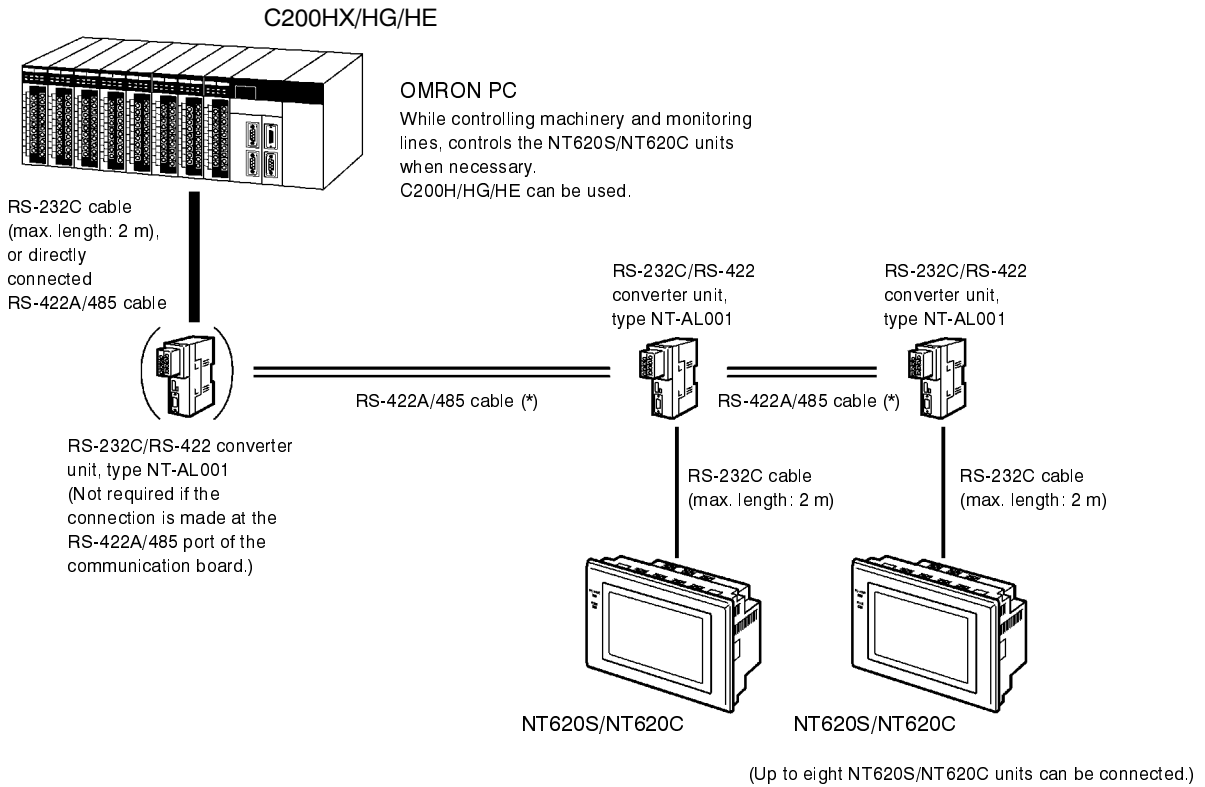

(\*) Total cable length: 500 m

**[Maximum Number of NT620S/NT620Cs Connectable to One Port]**

The maximum numbers of NT620S/NT620C units that can be connected to the built-in RS-232C port of the CPU and ports A and B of the communication board, respectively, are as follows.

- C200HE :Up to 4 NT620S/NT620C units per port (unit Nos. 0 to 3)
- C200HG, C200HX :Up to 8 NT620S/NT620C units per port (unit Nos. 0 to 7)

**Reference**

When connecting the C200HX/HG/HE and an RS-232C/RS-422 converter unit, use a converter unit whose lot number is 15Y5 or higher. Converter units of lot numbers previous to 15Y5 cannot be connected.



**Converter Unit Connector Specifications**

The terminal block specifications of the RS-232C/RS-422 converter unit are indicated here. For details on the method for making the connection cable, refer to “Making the Cable” (page 340 of the appendix).

NT-AL001 RS-422A terminal block specifications

- Connected terminal block RS-422A terminal block (M3 screws)
- Electrical characteristics Conform to EIA RS-422A
- Signal direction Signal input and output is relative to the NT-AL001.

Terminal Block Pin No.	Signal Name	Abbreviation	Signal Direction	
			Input	Output
8	Request to send (A)	CSA (CS-)		○
7	Request to send (B)	CSB (CS+)		○
6	Receive data (A)	RDA (RD-)	○	
5	Receive data (B)	RDB (RD+)	○	
4	Send data (A)	SDA (SD-)		○
3	Send data (B)	SDB (SD+)		○
2	Signal ground	SG (GND)	-	-
1	Functional ground		-	-

\* The CSA and CSB signals are for special applications.

**Terminal Screws and Crimp Terminals**

The terminal screws are M3 screws. Use M3 size crimp terminals. Tighten the terminal screws with a torque of 0.4 N·m.

**Note** During wiring, crimp terminals must be used for connections.

**[Recommended crimp terminals]**

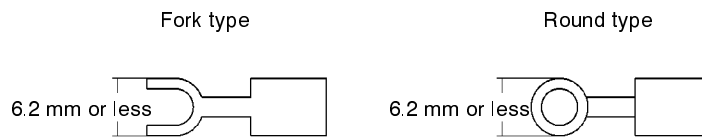

Maker	Type	Recommended Wire Size
Japan Solderless Terminal MFG	1.25-N3A (fork)	AWG22 to 18 (0.3 to 0.75 mm <sup>2</sup> )
Molex	Y1.25-3.5L (fork)	

**Wiring Method and Settings Relating to Wiring**

The wiring method for the connections between the PC and NT620S/NT620C units, and the settings of each piece of equipment related to wiring, are described here. The wiring method and settings to be made depend on the type of cable (RS-422A or RS-485), as shown below.

• RS-422A Cables

When using RS-422A cables, note the following points.

- The wiring method for RS-422A cables is different for the connection closest to the PC than for other connections. Follow the instructions below in order to complete the wiring correctly.
- Always set a terminal resistor (terminator) at both ends of the RS-422A cable. Do not set terminal resistors at any other positions.
- When equipment has functional ground terminals, always connect the shielding of the RS-422A cable to these terminals.
- Always use an RS-232C/RS-422A converter unit (NT-AL001) to make a connection between an NT620S/NT620C and an RS-422A cable.

The actual wiring and settings depend on the system configuration, as shown below.

**[When the PC is RS-232C]**

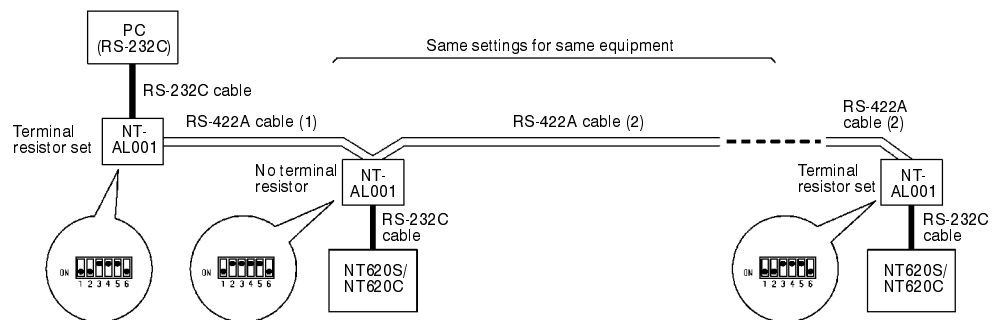

**[When the PC is RS-422A]**

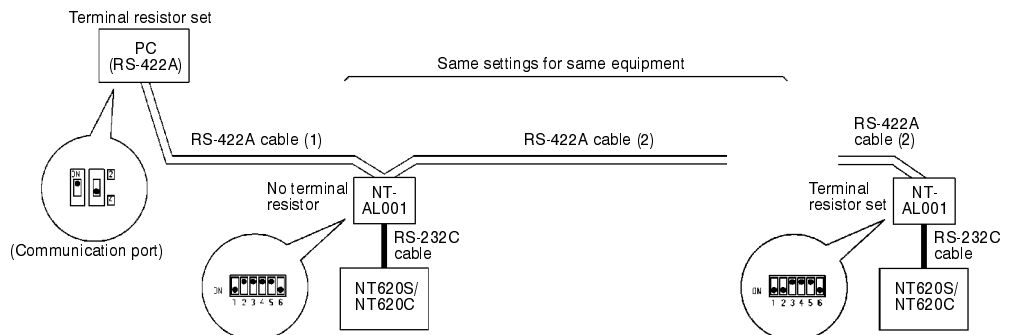

- RS-232C Cable Wiring

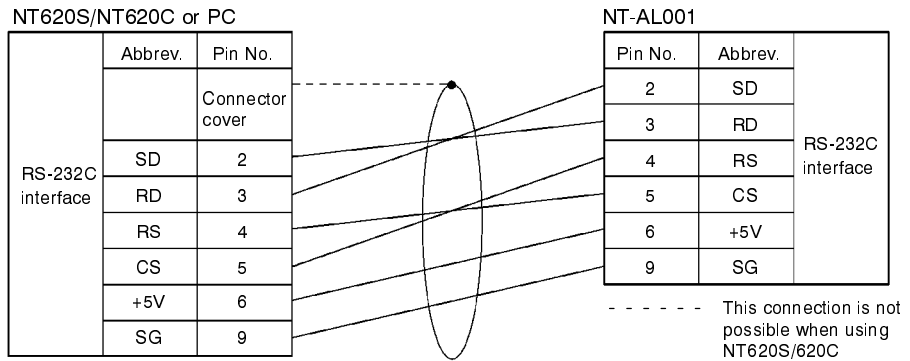

- RS-422A Cable Wiring (1)

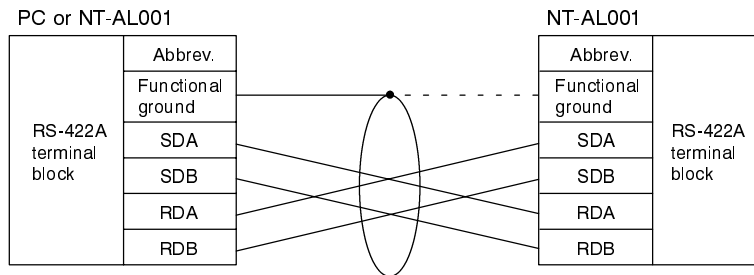

- RS-422A Cable Wiring (2)

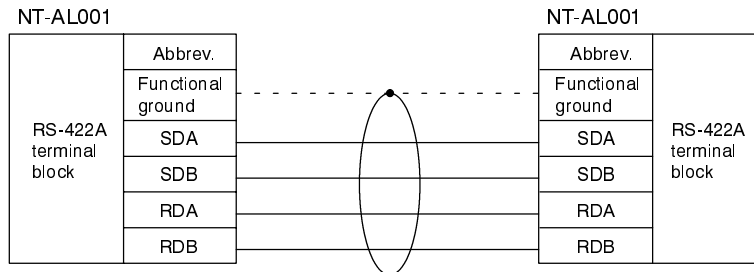

• RS-485 Cables

When using RS-485 cables, note the following points.

- The wiring for RS-485 cables is always the same regardless of the location. Follow the instructions below in order to complete the wiring correctly.
- Always set a terminal resistor (terminator) at both ends of the RS-485 cable. Do not set terminal resistors at any other position.
- When equipment has functional ground terminals, always connect the shielding of the RS-485 cable to these terminals.
- Always use an RS-232C/RS-422A converter unit (NT-AL001) to make a connection between an NT620S/NT620C and an RS-485 cable.

The actual wiring and settings depend on the system configuration, as shown below.

**[When the PC connection is RS-232C]**

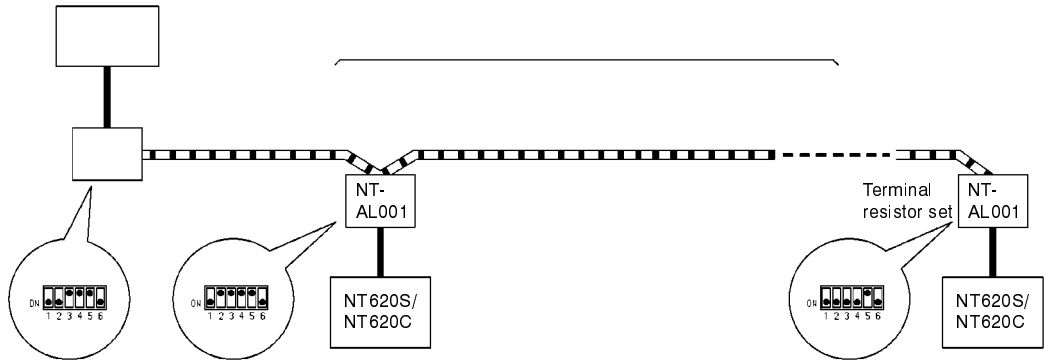

**[When the PC connection is RS-485]**

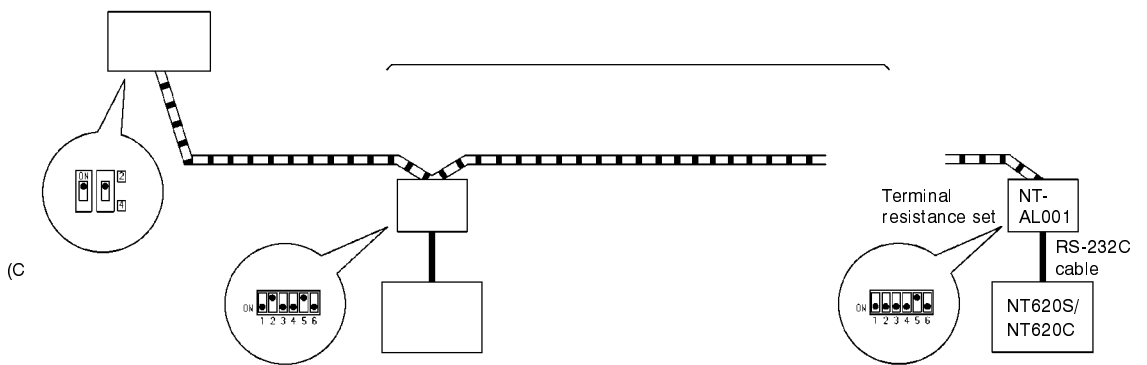

- RS-232C Cable Wiring

Same as described in "RS-422A Cables" on page 52.

- RS-485 Cable Wiring

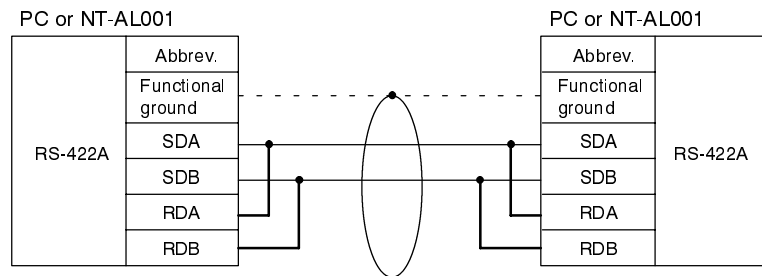

### 2-7-3 PC Switch Settings

When the PC and NT620S/NT620C units have been connected, set the switches at the CPU module at the PC side in order to enable communication using the NT link method.

- C series, C200HX/HG/HE

Write the communication conditions directly to the “PC system area” (data memory) using a peripheral tool (e.g., SYSMAC support software). For details on the operation for setting the “PC system area”, refer to the “SYSMAC C200HX/HG/HE OPERATION MANUAL” (W303-E1-□).

[PC system setting area setting]

With C200HX/HG/HE, the setting area differs according to which port among the standard port of the CPU module and the ports of the expansion communication board is used for the connection.

Port	Channel #	Writing Value	Settings
C200HX/HG/HE RS-232C port	DM6645	5□00	Use NT link (1:N) □ = highest unit No. in the maximum number of connectable PTs (1 to 7). (*)
C200HX/HG/HE port A	DM6555		
C200HX/HG/HE port B	DM6550		

(\*) When using C200HE, the PT unit No. range is 1 to 3.

## 2-8 Communication with the Host Using Memory Link

Connect the NT620S/NT620C and host (personal computer, computer for FA applications, etc.) using the memory link method.

In order to do this, the “memory link” system must be installed using the system installer.

In addition, the communication conditions must be set. Select the communication conditions from the following in accordance with the host used (see page 78).

Item	Setting
Data bit length	7/8 bits
Stop bit	1/2 bits
Parity	None/even/odd
Baud rate	2400/4800/9600/19200 bps
Flow control	None, RS/CS, XON/XOFF
Response	No, Yes

### 2-8-1 Connection Method

Make the connection cable by referring to the description of the RS-232C type or RS-422A type host link method and the connector specifications for the host to be connected. If the host is an IBM PC/AT or compatible and the connection is RS-232C, the support tool connection cable can be used without alteration. For details on cables, refer to Appendix G “Method for Making the Cable for Connection to the PC” (page 332).

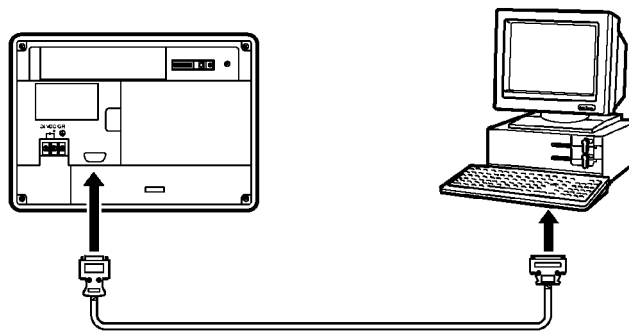

### 2-8-2 Host Settings

Set the same communication conditions at the host as were set at the NT620S/NT620C. For details on the setting method, refer to the instruction manual for the host used.

## 2-9 Connecting a Printer

Hardcopies of screens can be printed (printing of screen images) onto a printer connected to the NT620S/620C.

In order to make a hard copy at a printer connected to the NT620S/620C, it is necessary either to create a screen print key as a touch switch on the screen to be printed during screen creation, or to issue a print instruction from the PC. For details, see 4-7 "Touch Switches" (page 161), and 5-7 "NT620C/620C Status Control" (page 257).

### 2-9-1 How to Connect

Connect the printer to the NT620S/620C with a Centronics cable. The length of the cable should not exceed 3 meters.

#### Reference

If the connection cable is connected or disconnected while the power of the printer is on, the NT620S/620C may malfunction. Make sure to turn off the power of the printer before connecting or disconnecting the connection cable.

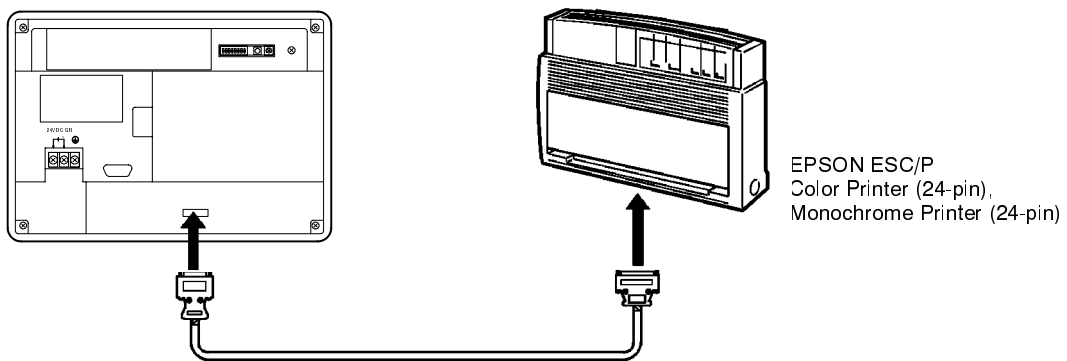

- **Recommended connection cable**

The following connection cable is recommended.

NT-CNT121 connection cable (1.5 m, 20-pin to 36-pin)

- **Recommended printer**

EPSON ESC/P Printer (24-pin), Color or Monochrome

HP Printer, Monochrome

If using other printer, such printer should conform to ESC/P 24-J81, which is the printer control standard of Epson.

If using an HP printer, make sure that it conforms to the "PCL5" standard.

When using a monochrome printer with an NT620S/620C, set "ESC/P TONE" with the NT620S/620C memory switches (see page 94).

---

## SECTION 3

# System Menu Operation

This section describes the operation of the System Menu focusing on the procedure to start up the NT620S/620C.

Functions which will be convenient to use the NT620S/620C and those which are useful for the system maintenance are also explained here.

3-1	Operation Flow by the System Menu .....	59
3-2	Starting the NT620S/620C .....	60
3-2-1	Changing the System Settings etc. ....	60
3-3	Operation Modes and the System Menu .....	61
3-3-1	System Menu and the Operation Modes .....	61
3-3-2	Menu Tree .....	62
3-3-3	Operations with the System Menu .....	63
3-4	Initializing Memory .....	65
3-4-1	Initialization of the Screen Data .....	66
3-4-2	Initialization of the Memory Tables .....	68
3-4-3	Initialization of the Display History Data Memory .....	70
3-5	Setting the Conditions of Communications with the PC by Using the Memory Switches .....	72
3-5-1	Selecting the Host Communication Method .....	74
3-5-2	Selecting the Host Link Communication Speed (Host Link Only) .....	76
3-5-3	Setting Unit Numbers (NT Link 1:N Only) .....	77
3-5-4	Setting the Communication Conditions for Memory Link .....	78
3-6	Registering the Screen Data .....	80
3-7	Starting the Operation .....	84
3-8	Various System Settings .....	85
3-8-1	Setting the Key Press Sound .....	86
3-8-2	Using the Buzzer .....	87
3-8-3	Screen Saver Function (NT620S) / Backlight OFF Function (NT620C) .....	89
3-8-4	Resume Function .....	91
3-8-5	Screen Printing Function .....	93
3-9	System Maintenance .....	96
3-9-1	Using the Display History Recording Function .....	96
3-9-2	I/O Check .....	100
3-9-3	Checking the PT Setting Status .....	116



## 3-1 Operation Flow by the System Menu

Follow the procedure below when using the NT620S/620C for the first time or when changing the system.

### Reference

A dedicated system program is required in order to use the memory link. Refer to 2-4 "Installing the System Program" (page 30).  
Be sure to install the system program in advance.

### Create the Screen Data

Create the screen data to be displayed on the NT620S/620C by using a support tool.

For the screen data creation, refer to the "NT-series Support Tool Operation Manual" (V028-E1-01).

### Start Up the NT620S/620C (Display the System Menu.) (page 60)

Turn ON the power to the NT620S/620C.

When no screen data has been registered, the "SYSTEM MENU" will be displayed. If the NT620S/620C enters the RUN mode, press appropriate touch switches to display the System Menu.

### Initialize Memory (page 65)

Select a System Menu and initialize the NT620S/620C unit memory.

### Memory Switch Setting (page 72)

Select the System Menu and set the conditions for communications with the PC using the memory switch.

### Transfer the Screen Data (page 80)

Connect a support tool to the NT620S/620C and transfer the screen data from the support tool to the NT620S/620C.

For the connection of a support tool, refer to Section 2-3 "Connecting to the Support Tool". (page 29)

### Start the Operation (page 84)

Connect to the PC and start the operation.

### System Maintenance (page 96)

If an error has occurred during operation, check the I/Os, settings, etc. referring to this guide.

## 3-2 Starting the NT620S/620C

When the NT620S/620C is started, it will enter the RUN mode if system settings and screen data registration have been completed. If no screen data has been registered or the screen data are destroyed, the System Menu will be displayed.

Before turning ON the power, check the following DIP switch settings on the NT620S/620C.

- SW2-3 “Switch to the System Menu enabled/disabled” is set to OFF (enabled).
- SW2-1 “Screen data forced initialize Yes/No” is set to No (ineffective).
- DIP switch 8 “System program delete” is set to OFF (normal operation mode).

For the DIP switch settings of the unit, refer to the “DIP switch settings” (page 24).

### 3-2-1 Changing the System Settings etc.

Follow the procedure below to change the system settings or screen data contents.

- Procedure** 1. Turn ON the power to the NT620S/620C.

The NT620S/620C will enter the RUN mode and the start-up screen will be displayed. The start-up screen varies according to registered screen data.

2. Press appropriate touch switches to display the System Menu, and change system settings. For the method for calling the System Menu, refer to the “Operations with the System Menu” (page 63).

If no system program is installed or the system program has been destroyed, the system program must be installed. For the installation method, refer to 2-4 “Installing the System Program” (page 30).

If the NT620S/620C has failed to start up normally; an error message is displayed or no screen is displayed, memory needs to be initialized.

For the memory initializing procedure, refer to Section 3-4 “Initializing Memory” (page 65).

### 3-3 Operation Modes and the System Menu

The NT620S/620C operates in either “RUN”, or “Transmit” mode. The operation modes can be switched by using the System Menu.

#### 3-3-1 System Menu and the Operation Modes

Select an operation mode by pressing the corresponding touch switch in the System Menu. The operation modes with respect to the System Menu are related to each other as shown below.

For the operations with the System Menu, refer to the “Operations with the System Menu” (page 63).

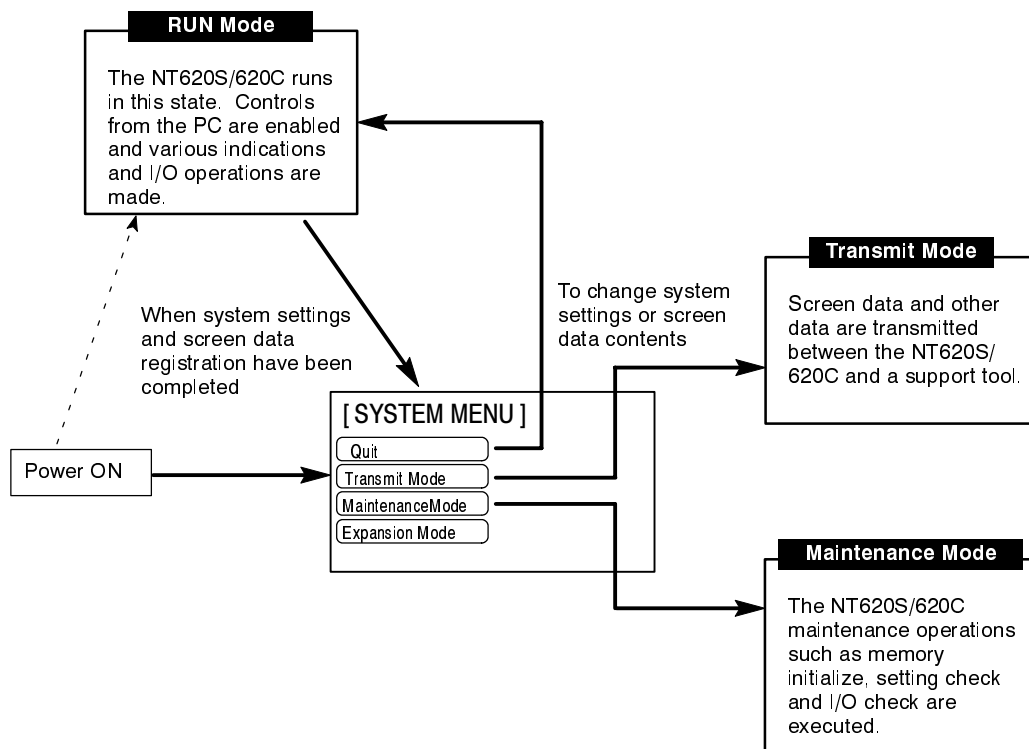

### 3-3-2 Menu Tree

The System Menu allows to effect various NT620S/620C functions by using the touch switches. The NT620S/620C's functions with respect to the System Menu are related as shown below.

For the operations with the System Menu, refer to the "Operations with the System Menu" (page 63).

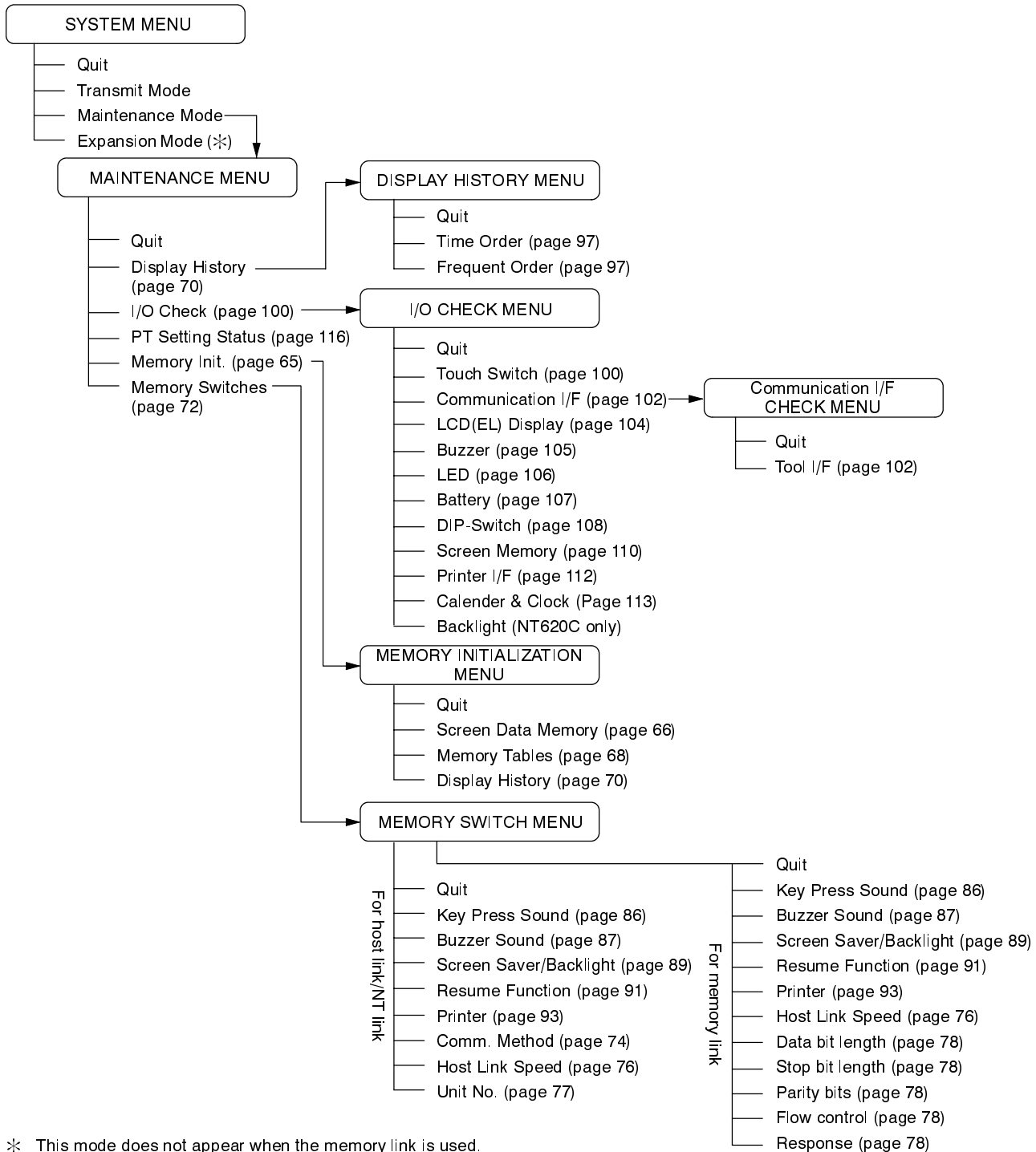

\* This mode does not appear when the memory link is used.

### 3-3-3 Operations with the System Menu

The following gives the procedure to call the System Menu, select the menu items, and other operations with the System Menu.

Make sure that DIP SW2-3 “Switch to the System Menu enabled/disabled” is set to OFF (enabled). If the setting is ON (disabled), the System Menu will not be displayed by following the procedure given below.

**Displaying the System Menu** Press appropriate touch switches to display the System Menu as mentioned below. The “RUN” LED goes off when the System Menu is displayed.

The NT620S/620C display screen has four touch switches to display the System Menu in the four corners (measuring 6.0 mm horizontally by 7.5 mm vertically in the case of the NT620S and 6.0 mm square in the case of the NT620C). Press any two of these switches at the same time to call the System Menu screen.

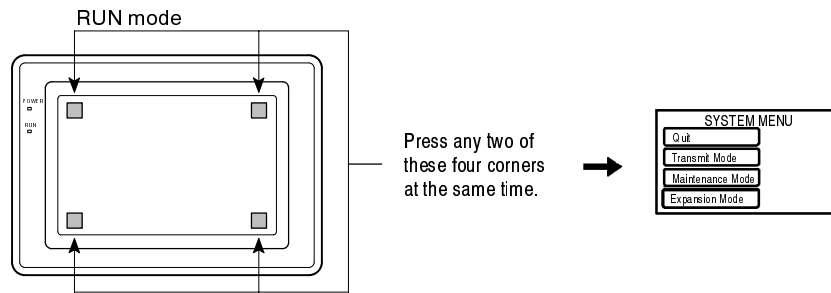

Note that the touch switches used to call the System Menu are not displayed on the screen. If a touch switch displayed in a corner is pressed first, the touch switch will function and the System Menu will not be displayed. To successfully call the System Menu, first press a corner where no touch key is displayed, and then, press any other corner regardless of the presence of a touch key.

If a screen has the touch switches registered at all of the four corners, it is impossible to call the System Menu from the screen.

In this case, switch to a screen that does not have touch switches at its four corners.

A “system key” function can be assigned to a touch switch. Pressing the touch switch so assigned on the screen can easily display the System Menu. For the relationship between the system key and the touch switch, refer to the “System key functions” (page 167).

**Selecting the Menu Items**

Press (touch) a menu item on the screen to select the item.

Menu items allow to make the ON/OFF selection or to call subsequent menu or screen.

**Example 1**

To call the “Maintenance Mode Menu” by pressing the “Maintenance Mode” on the System Menu screen:

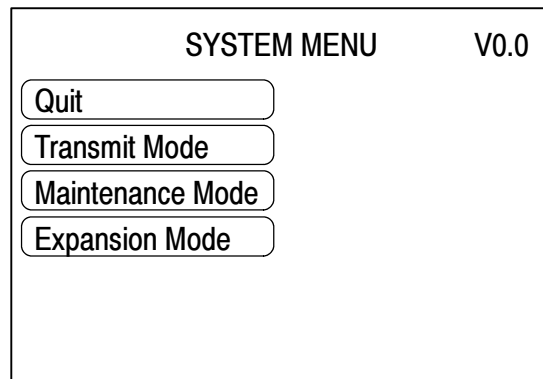

Select “Maintenance Mode”.

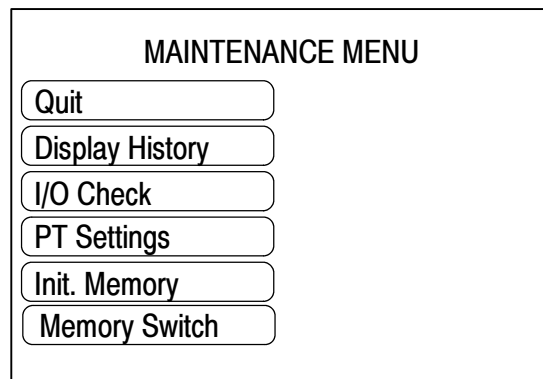

**System Menu Items**

The System Menu items and the functions are as given below.

Menu Item	Function
Quit	The System Menu screen is cleared and the NT620S/620C will return to the RUN mode.
Transmit Mode	The Transmit Mode screen will be displayed to allow the transmission of the screen data between the NT620S/620C and the support tool. For the transmission of the screen data, refer to Section 3-5 “Registering the Screen Data” (page 80).
Maintenance Mode	The Maintenance Mode menu will be displayed to allow the maintenance of the NT620S/620C system.
Expansion Mode	For future expansion. Currently not used.

**Switching from the System Menu to the RUN Mode**

The NT620S/620C will exit the System Menu and switch to the RUN mode in the cases mentioned below.

- Selecting “Quit” in the System Menu.
- The screen (touch switches) is not pressed for over 10 seconds.

## **3-4 Initializing Memory**

If the NT620S/620C is used for the first time or if the screen data is ruined and the NT620S/620C cannot be normally started, the memory needs to be initialized.

The memory initialization is required in the cases mentioned below.

---

### **Reference**

- When the screen data memory is initialized, all the screen data that was stored in the NT620S/NT620C up to that point is cleared. Check that the created screen data is backed up in a floppy disk before initializing.
  - If no system program is installed or the system program has been destroyed, the system program must be installed. For the installation method, refer to 2-4 "Installing the System Program" (page 30).
- 

- The following memory data can be initialized.

Image data memory

Memory tables

Display history

The screen data can be initialized regardless of the setting for Resume Function (see page 91).

### 3-4-1 Initialization of the Screen Data

The screen data can be initialized by either of the following two methods.

- Initialization by using the System Menu
- Initialization by using the DIP switch (Forced Initialization)

#### Initialization by using the System Menu

Initialize the image data memory by following the procedure given below.

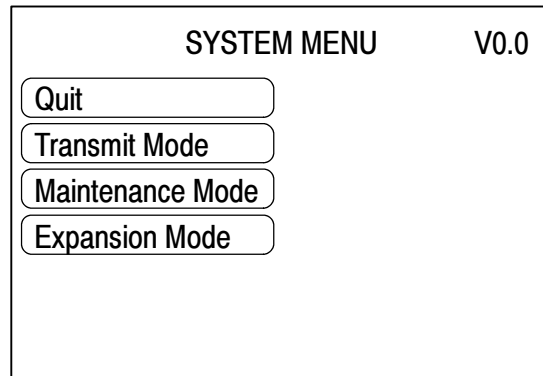

Select "Maintenance Mode".

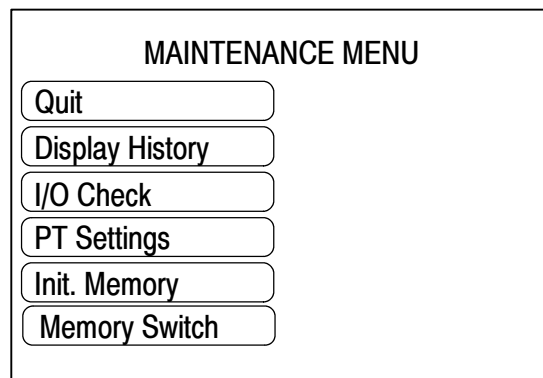

Select "Init. Memory".

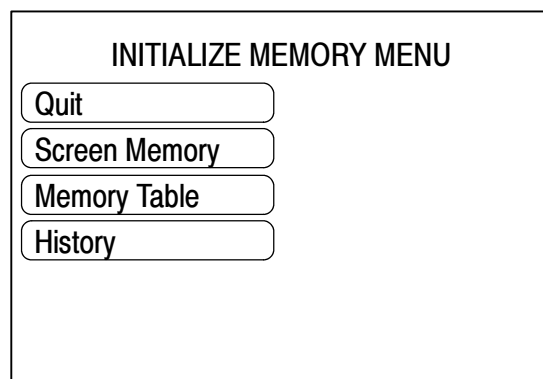

Select "Screen Memory".





**Initialize Screen Memory?**

Select "Yes".

The screen data memory is initialized. During the initialization, the "Initializing" message will be displayed.

- If "No" is selected, the memory initialization will be canceled and the NT620S/620C returns to the "INITIALIZE MEMORY MENU".

Upon completion of image data memory initialization, the NT620S/620C returns to the "INITIALIZE MEMORY MENU".

After the screen data memory has been initialized, if an attempt is made to set the NT620S/620C to the RUN mode before screen data has been transferred from the support tool, the error message "No direct information is set!!" will be displayed.

**Initialization by Using the DIP Switch (Forced Initialization)**

**Note** Be sure to turn the power OFF before setting the NT620S/620C DIP switch.

Set the DIP switch as follows to initialize the screen data memory.

**Operation** 1. Set DIP SW2-1 on the NT620S/620C to ON and turn the power ON.

**Initialize Screen Memory?**

Select "Yes". The screen data memory is initialized. During the initialization, the "Initializing" message will be displayed.

- If "No" is selected, the memory initialization will be canceled.



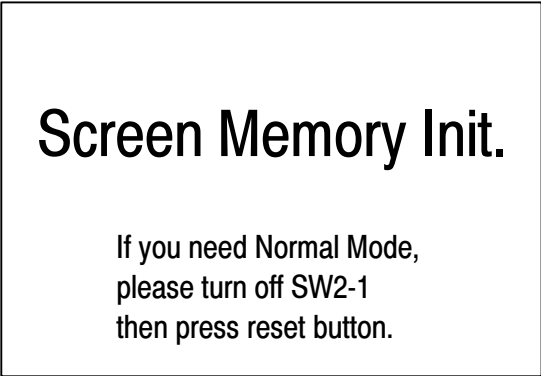

2. Turn the NT620S/620C power to OFF.
3. Set NT620S/620C DIP SW2-1 to OFF and turn the power ON.

**Reference**

Selecting “No” will cancel the memory initialization. To change the system settings or to register the screen data, set DIP SW2-1 to OFF and start the NT620S/620C, and then, call the System Menu screen.

The NT620S/620C DIP SW2-1 is used to set “Screen data forced initialize effective/ineffective”. Setting this to ON selects “effective”, and OFF “ineffective”.

**3-4-2 Initialization of the Memory Tables**

It is possible to initialize the numeral memory tables and character-string memory tables in the NT620S/620C. “Initialization of the memory tables” means overwriting the present values in the memory tables in the NT620S/NT620C with the initial settings set with the support tool.

If a memory table is initialized in the Maintenance Mode, it is initialized regardless of the setting for the resume function (resume function: page 91).

If “Effective” is set for the “Resume Function” memory switch, the initial values set with the support tool will not be reflected in the present values of the memory tables unless the memory tables are initialized.

**Reference**

If “Ineffective” is set for the “Resume Function” memory switch, the memory tables can be initialized just by switching the NT620S/NT620C power off and back on again, or by resetting it.

Using the System Menu, initialize the memory tables by following the procedure given below.

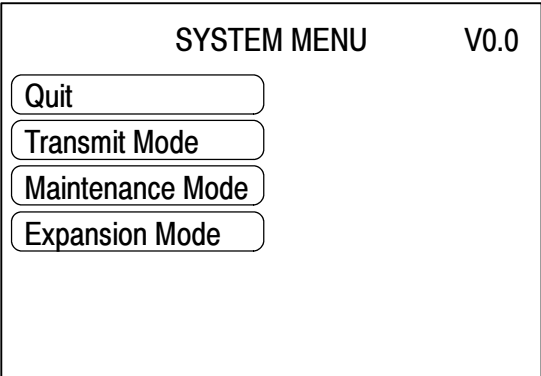

Select “Maintenance Mode”.



**MAINTENANCE MENU**

Select "Init. Memory".



**INITIALIZE MEMORY MENU**

Select "Memory Table".



**Initialize Memory Table?**

Select "Yes".

The memory table is initialized.

- If "No" is selected instead of "Yes", the NT620S/620C returns to the "INITIALIZE MEMORY MENU" without initializing the memory.

Upon completion of memory table initialization, the NT620S/NT620C returns to the "INITIALIZE MEMORY MENU".

### 3-4-3 Initialization of the Display History Data Memory

The display history (page 96) is stored in the order of occurrence (time order) or the order of frequency (frequent order). Since no more display history data can be stored after the number of registered items has reached 1023 items, the memory has to be initialized at regular intervals.

The display history data memory can be initialized by a command given from the PC.

Using the System Menu, initialize the display history data memory by following the procedure given below.

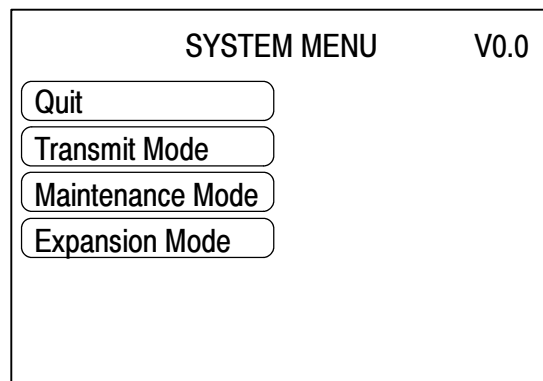

Select "Maintenance Mode".

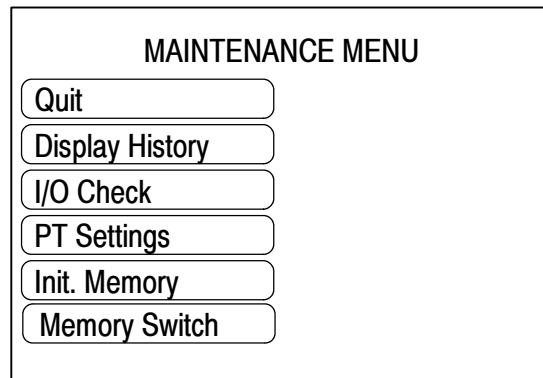

Select "Init. Memory".

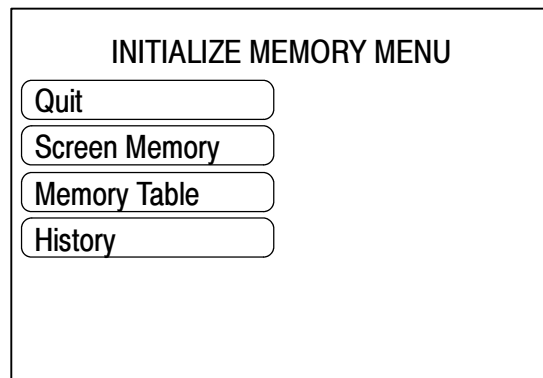

Select "History".



Initialize History?

Select "Yes".

The display history data memory is initialized.

- If "No" is selected instead of "Yes", the NT620S/620C returns to the "INITIALIZE MEMORY MENU" without initializing the memory.

Upon completion of display history data initialization, the NT620S/620C returns to the "INITIALIZE MEMORY MENU".

### 3-5 Setting the Conditions of Communications with the PC by Using the Memory Switches

The NT620S/620C can be connected to a PC by the host link, NT link (1:1), NT link (1:N) or memory link. The link can be selected by setting the memory switch. Also, the host link baud rate, resume function effective/ineffective, etc. are set with the memory switches.

This section describes the communications condition settings by using the memory switches.

#### Memory Switches

The NT620S/620C has the memory areas used to store the PC connection method, communications conditions, system settings, etc. which can be used as the switches and called the "memory switches". Since the memory switches use the flash memory, the stored data can be held even when the power supply is turned OFF.

#### Reference

If the memory switch data is not backed up by the built-in battery, it will all be initialized to the values set with the support tool when the NT620S/620C is switched OFF.

If the message "Battery Lowered" is displayed while the NT620S/620C is operating, replace the built-in battery immediately. For details on how to replace the battery, see "Replacing the Battery" (page 307).

#### Setting Functions and the Memory Switch Menu

The memory switches can be set easily by using the memory switch menu in the System Menu.

The memory switches can also be set by selecting "In.Scr" [F8] on the "File Selection" screen of the support tool. The settings made using the support tool are written to the NT620S/NT620C on screen data registration. For details, refer to the NT-series support tool operation manual (V028-E1).

The settings that can be recorded for the memory switches are shown below. For details on each function, see the next section and 3-8 "Various System Settings" (page 85).

#### [Host Link/NT Link]

MEMORY SWITCH MENU	
Quit	Comm. Method Host Link
Key Press Sound ON	Host Link Speed 9600bps
Buzzer Sound ON	
Screen Saver None	
Resume Function ON	
Printer ESC/P TONE	

**[Memory Link]**

MEMORY SWITCH MENU	
Quit	Host Link Speed 2400 bps
Key Press Sound ON	Data Bit Length 8 bits
Buzzer Sound ON	Stop Bit Length 1 bit
Screen Saver None	Parity Bit Odd
Resume Function ON	Flow Control RS/CS
Printer ESC/P TONE	Response Always

- Key Press Sound 3-8 Various System Settings (page 86)
- Buzzer Sound 3-8 Various System Settings (page 87)
- Screen Saver/Backlight  
3-8 Various System Settings (page 89)
- Resume Function 3-8 Various System Settings (page 91)
- Printer 3-8 Various System Settings (page 93)
- Comm. Method Selecting the Host Communication Method (page 74)
- Host Link Speed Selecting the Host Link Communication Speed (page 76)
- Unit No. Setting the unit number (page 77)

“Comm. Method” and “Host Link Speed” can only be set from the memory switch menu called from the system menu.

In addition, the following settings can only be set from the support tool.

- Number of numeral memory tables  
Numeral Memory Tables (page 142)
- Number of character-string memory tables  
Character-String Memory Tables (page 139)
- Alarm FIFO Alarm History Display (page 196)

### 3-5-1 Selecting the Host Communication Method

The NT620S/620C can be connected to a PC by the host link, NT link (1:1), NT link (1:N) or memory link. Either link can be selected by setting the “Comm. Method” memory switch.

However, if using the memory link, install the dedicated system program using the system installer.

Select the communication method that is supported by the connected PC.

The factory setting is not fixed.

Select the host communication method by the menu operation from the System Menu as mentioned below.

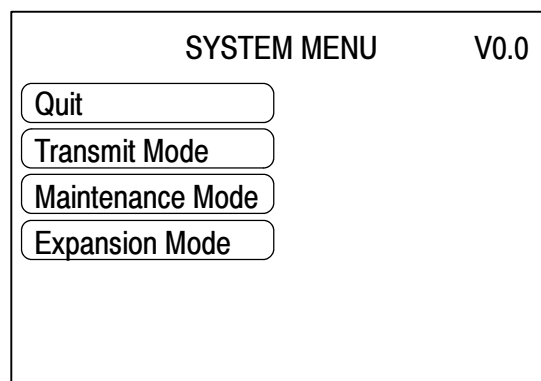

Select “Maintenance Mode”.

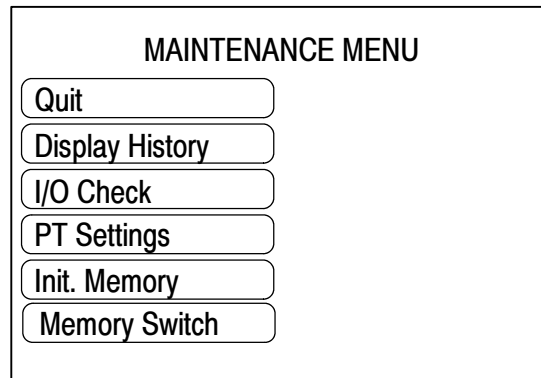

Select “Memory Switch”.

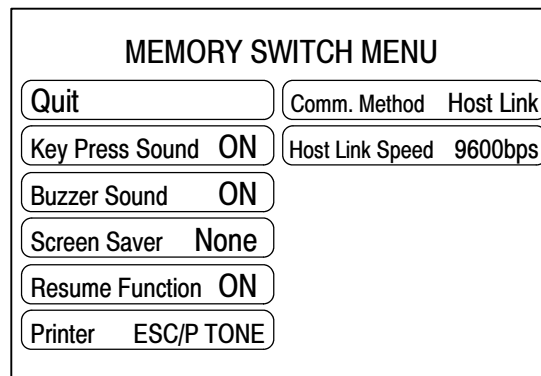

**[For host link/NT link]**

Each time the “Comm. Method” touch switch is pressed, the setting option changes to the next item in the sequence “Host Link”, “NT Link”, “1:N NT Link”.



Or,

MEMORY SWITCH MENU	
Quit	Host Link Speed 2400bps
Key Press Sound ON	Data Bit Length 8 bits
Buzzer Sound ON	Stop Bit Length 1 bit
Screen Saver None	Parity Bit Odd
Resume Function ON	Flow Control RS/CS
Printer PR201H TONE	Response Always

**[For memory link]**

This screen is only displayed when the system program dedicated to the memory link has been installed. Since it is a dedicated system program, no communication method setting is required.

On completing setting, press the “Quit” touch switch. The settings made last will be set and the display will return to the “MAINTENANCE MENU”.

### 3-5-2 Selecting the Host Link Communication Speed (Host Link Only)

When the host link is used, the baud rate of the communications with the PC can be set. Note that the baud rate setting is made only with the host link communication method. Select 9600 bps or 19200 bps.

Select the baud rate of the communication with the PC by the menu operation from the System Menu as mentioned below.

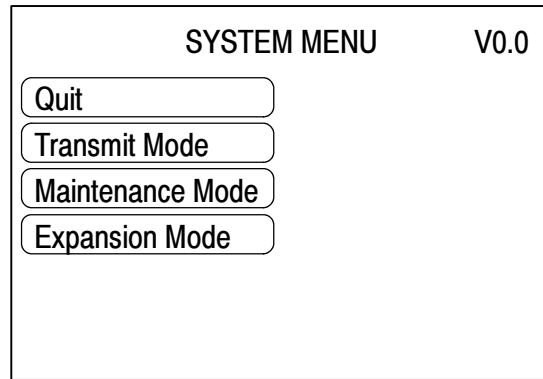

Select "Maintenance Mode".

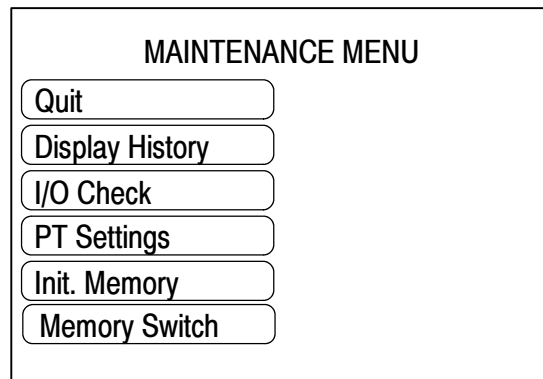

Select "Memory Switches".

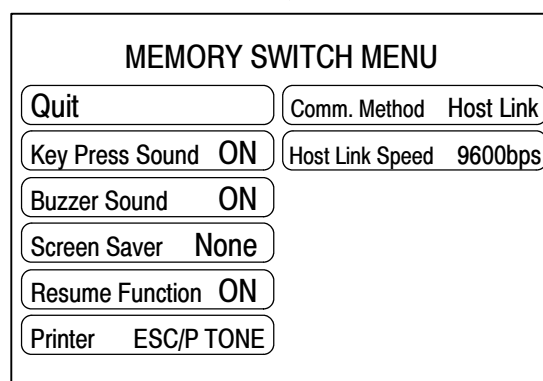

Each time the "Host Link Speed" touch switch is pressed, the setting option "9600 bps" alternates with "19200 bps".

To set and quit the menu, press the "Quit" touch switch. The settings made last will be set and the display will return to the "MAINTENANCE MENU".

### 3-5-3 Setting Unit Numbers (NT Link 1:N Only)

When using the NT620S/NT620C with the NT link (1:N) communication method, set unit numbers. When using NT link (1:N), unit numbers are used to identify each of the multiple PTs connected to a single PC port. Set a different unit number for each of the PTs connected to the port.

The unit numbers that can be set differ in accordance with the type of host PC as follows.

- C200HE :Unit Nos. 0 to 3
- C200HG, C200HX :Unit Nos. 0 to 7

Set the unit numbers by following the menu operation from the System Menu described below.

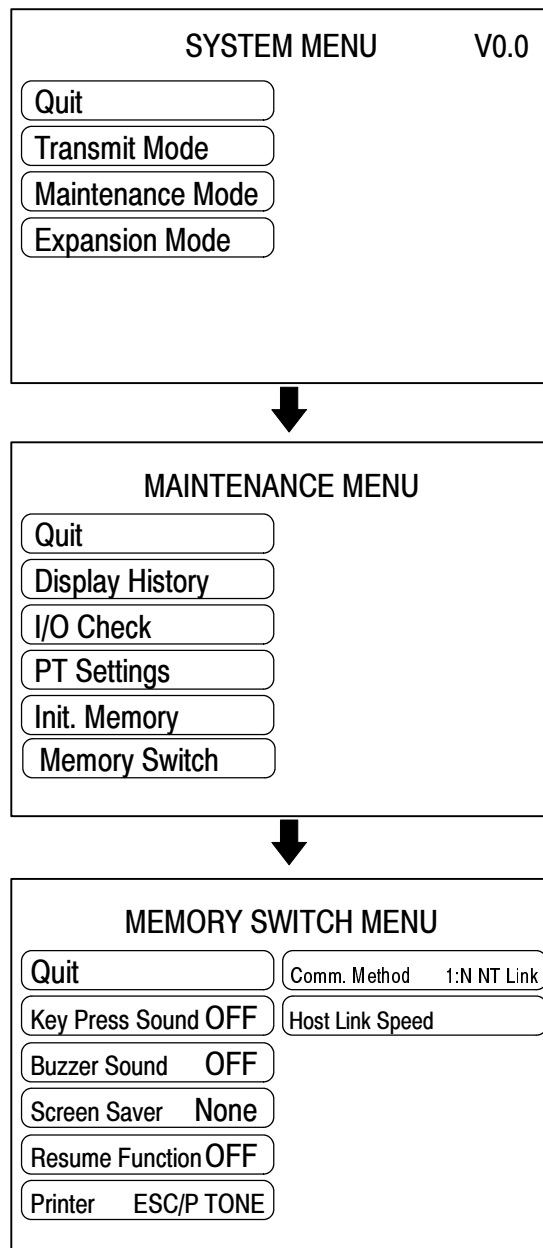

To set and quit the menu, press “Quit”. The final settings made will be set and the screen will return to the maintenance mode menu.

### 3-5-4 Setting the Communication Conditions for Memory Link

When connecting the NT620S/NT620C to the host by the memory link method, set the communication conditions with the memory switches.

In order to use the memory link method, the dedicated system program must be installed.

Select the communication conditions from the following in accordance with the host used.

Item	Setting
Baud rate	2400, 4800, 9600, 19200 bps
Data bit length	7/8 bits
Stop bit length	1/2 bits
Parity	None/even/odd
Flow control	None, RS/CS, XON/XOFF
Response	No, Yes (Sets whether or not a response is returned even when a command from the host is processed correctly. See page 273.)

Set the memory link communication conditions by following the menu operation from the System Menu described below.

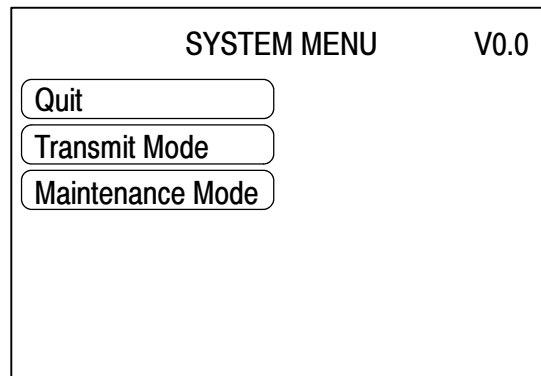

Select "Maintenance Mode".

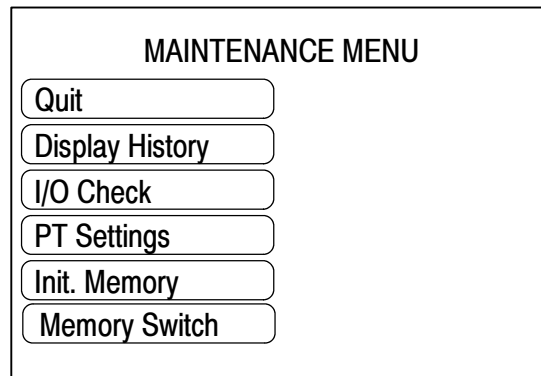

Select "Memory Switch".



MEMORY SWITCH MENU	
Quit	Host Link Speed 2400 bps
Key Press Sound OFF	Data Bit Length 8 bits
Buzzer Sound OFF	Stop Bit Length 1 bit
Screen Saver None	Parity Bit Odd
Resume Function OFF	Flow Control RS/CS
Printer ESC/P TONE	Response Always

Set the communication conditions by pressing the touch switches to the right of each menu item.

- Host Link Speed 2400, 4800, 9600, 19200
- Data Bit Length 7 bits, 8 bits
- Stop Bit Length 1 bit/2 bits
- Parity Bit None, Odd, Even
- Flow Control None, XON/XOFF, RS/CS
- Response Always, No

To set and quit the menu, press "Quit". The final settings made will be set and the screen will return to the maintenance mode menu.

### 3-6 Registering the Screen Data

The screen data is created by using the support tool and registered to the NT620S/620C screen data memory. This section describes the procedure to register the screen data to the NT620S/620C. For the screen data creation and the support tool operation, refer to the NT-series Support Tool Operation Manual (V028-E1-□).

#### Transmission – Transmission in File Units

The NT620S/620C uses several screens which are switched on its display. The screen data of one NT620S/620C unit corresponds to the files created by using the support tool. Select a file which contains the screen data to be transmitted when selecting the screen data to be transmitted to the NT620S/620C so that the required screen data can be transmitted to the NT620S/620C.

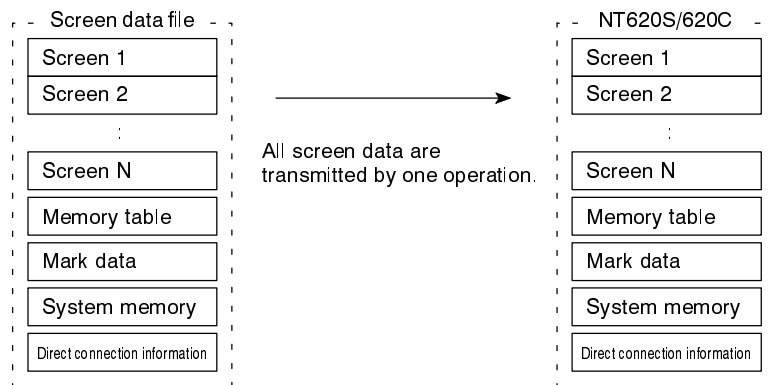

When screen data is transmitted from the support tool to the NT620S/620C, all existing screen data in the NT620S/NT620C is deleted.

Transmission in screen units is not possible with the NT620S/620C.

If an error message and the System Menu are displayed immediately after the NT620S/620C has been started, the screen data memory needs to be initialized.

#### Transmitting the Screen Data from the Support Tool

To transmit the screen data from the support tool to the NT620S/620C, connect the NT620S/620C to the computer on which the support tool is being used, and follow the procedure below.

**Reference**

- When screen data transmission is performed, the NT620S/620C screen data memory is automatically initialized before the new screen data is transmitted. There is therefore no need to initialize the screen data memory using menu operations before transmitting the screen data.
- The NT620S/620C uses the same connector for screen data transmission and connection to the PC. If the NT620S/620C is currently connected to the PC, disconnect the PC cable and connect the support tool (personal computer) cable to this connector before attempting screen data transmission.

- Operation**
1. Connect the NT620S/620C to the computer on which the support tool is being used, and turn ON the NT620S/620C.
  2. Turn ON the computer and start up the support tool.
  3. Enter the "Transmit Mode" by operating the menu of the NT620S/620C as mentioned below.

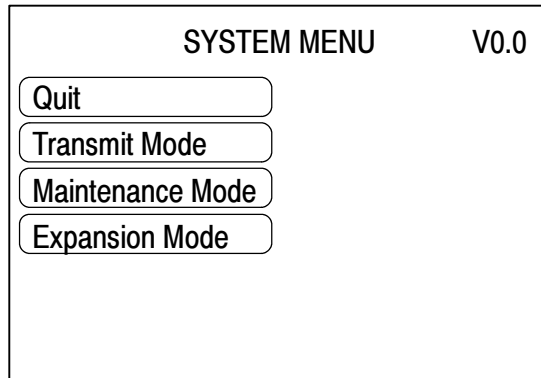

Select "Transmit Mode".

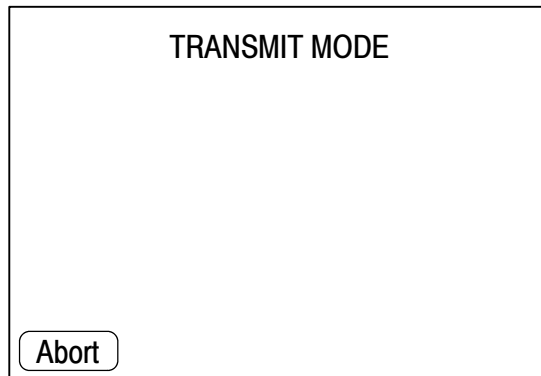

4. Select a screen data to be transmitted to the NT620S/620C in the File Selection screen of the support tool, and press the Send key.
5. The NT620S/620C will display the following screen when the screen data is being transmitted.

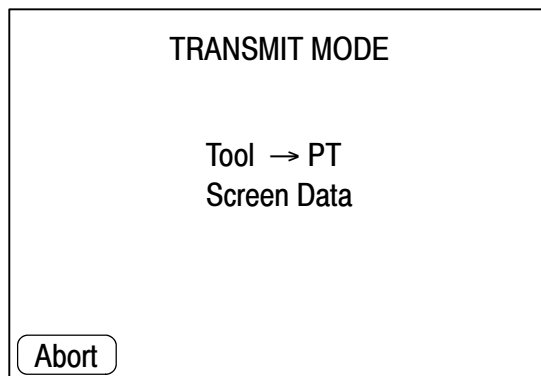

6. When the screen data transmission is completed, the support tool will display the following screen.

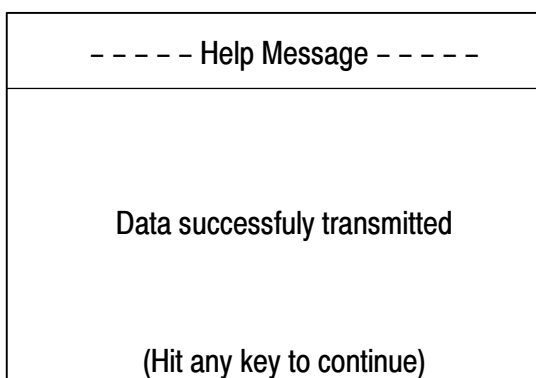

7. Press any key on the support tool to return to the File Selection screen.
8. Pressing the “Abort” touch switch in the Transmit Mode screen of the NT620S/620C will exit the Transmit Mode and enter the RUN Mode.

**Note**

---

Press the “Abort” touch switch on the NT620S/620C when the screen data transmission is completed. Unless this touch switch is pressed, the screen data will not be correctly registered. If the “Abort” touch switch is pressed during transmission, the screen data will not be correctly registered.

---

If screen data cannot be transmitted from the support tool properly, check whether communication between the NT620S/620C and support tool (personal computer) is normal.

To check communication with the support tool, use the “Tool Transmit” function in the maintenance mode of the NT620S/620C. See “Checking the Communications with the Support Tool” (page 102).



**Precautions to be Observed During the Screen Data Transmission**

When any of the following or a system error occurs during the screen data transmission, the transmitted screen data will not be registered correctly to the NT620S/620C. If an error message is displayed in the System Menu and the Transmit Mode cannot be selected, the screen data memory needs to be initialized.

- The power to the NT620S/620C is interrupted or the NT620S/620C is reset.
- The power to the computer on which the support tool is running is interrupted or the computer is reset.
- The cable connecting the NT620S/620C to the computer on which the support tool is running is disconnected or has a broken wire.
- The “No” touch switch on the NT620S/620C screen is pressed to end the transmission during screen data transfer.
- The “ESC” key on the support tool is pressed to end the transmission.

When the power to the NT620S/620C is turned ON or reset, the screen data is checked. However, if any of the above occurs during the screen data transmission, the screen may disappear and other unexpected problems may occur.

In the case of such problems, set DIP SW2-1 to ON to initialize the memory.

For the memory initialization by using the DIP switch, refer to the “Initialization by using the DIP switch” (page 67).

## 3-7 Starting the Operation

After completing the screen data transmission, connect the NT620S/620C to the PC and start the operation.

Check the operation of the screen data and host program carefully before starting operation.

**Switching to the RUN mode** Press the Quit touch switch in the System Menu. The start-up screen in the RUN mode will be displayed.

If the NT620S/620C has failed to start correctly; e.g., the start-up screen is not displayed, an error message is displayed, or the screen is not displayed at all, refer to Section 7-2 “Responding to Displayed Error Messages” (page 300) and take appropriate action.

### Reference

The start-up screen is the screen whose screen number is set for the screen switching specification in the PT status control area. If no screen data has been registered at screen number, the “Screen not registered.” error message will be displayed. For the screen number setting, refer to Section 4-3 “Screen Display” (page 135).

### Confirming the Communications between the NT620S/620C and the PC

Execute the PC program and confirm that the following operations are normally performed.

- Confirm that the NT620S/620C screens switch according to the PC/Host program execution.

If the screens do not switch correctly, check the connection between the NT620S/620C and the PC and also check the settings.

Refer to Section 2 “Hardware Settings and Connections”.

- Confirm that the information selected by the NT620S/620C touch switches has been set in the PC by displaying the contents of the words and bits using a peripheral tool (LSS etc.). If the information sent from the NT620S/620C has not been correctly received by the PC, check the screen data settings (specifically the switch settings).

For the details of the screen data creation, refer to the NT-series Support Tool Operation Manual (V028-E1-□).

## **3-8 Various System Settings**

The NT620S/620C can set a variety of functions to the memory switches which are convenient during the operation. This section describes the memory switch settings related to the operation environment.

The memory switches can also be set by selecting "In.Scr" [F8] on the "File Selection" screen of the support tool. The settings made using the support tool are written to the NT620S/NT620C on screen data registration. For details, refer to the NT-series Support Tool Operation Manual (V028-E1-□).

Since the memory switch data are backed up by the battery in the NT620S/NT620C, they are not cleared when the power is switched OFF.

---

**Reference**

If the memory switch data is not backed up by the built-in battery, it will all be initialized to the values set with the support tool when the NT620S/NT620C is switched OFF.

If the message "Battery Lowered" is displayed while the NT620S/620C is operating, replace the built-in battery immediately. For details on how to replace the battery, see "Replacing the Battery" (page 307).

---

### 3-8-1 Setting the Key Press Sound

Whether or not the key press sound is given when the NT620S/620C touch switch is pressed can be set with the memory switch.

The factory setting is not fixed.

Set the key press sound by the menu operation from the System Menu as shown below.

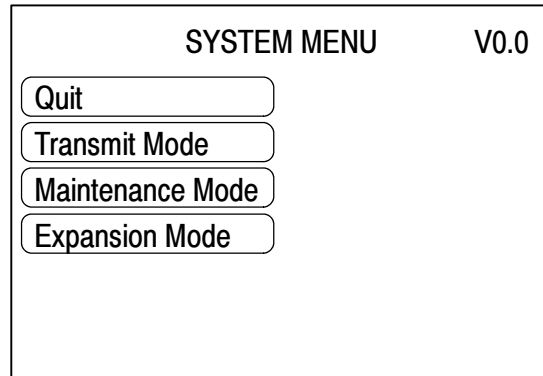

Select "Maintenance Mode".

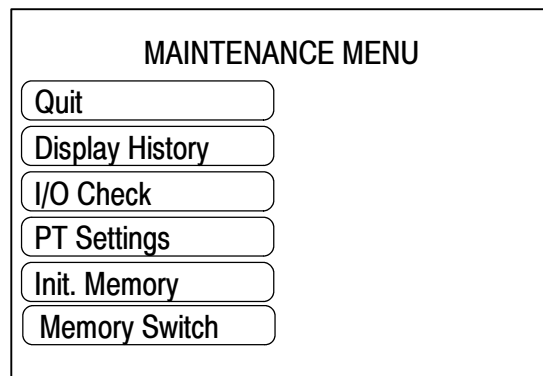

Select "Memory Switch".

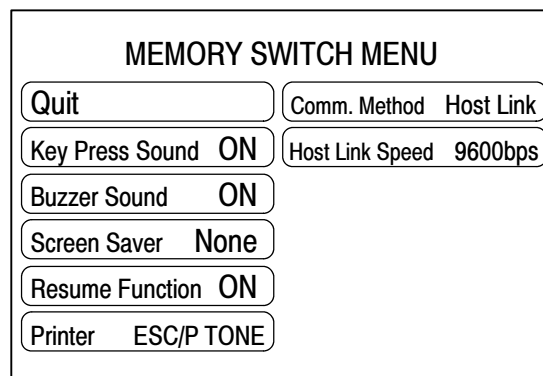

Each time the "Key Press Sound" touch switch is pressed, the setting option "ON" alternates with "OFF".

To set and quit the menu, press the "Quit" touch switch. The settings made last will be set and the display will return to the "MAINTENANCE MENU".

- ON: The key press sound will be given for 0.2 second when a touch switch is pressed.
- OFF: The key press sound will not be given when a touch key is pressed.

## 3-8-2 Using the Buzzer

The NT620S/620C can set a buzzer to indicate the occurrence of an emergency or an NT620S/620C error.

### Setting the Buzzer

Except when the buzzer has been set so as not to sound at all, the buzzer will sound when an error occurs. To set the buzzer to sound in other cases, the following two procedures can be used.

- Controlled by the host

It is possible to control the NT620S/620C from the host to sound the buzzer during the operation.

Refer to Section 5-7 “NT620S/620C Status Control” (page 257).

- Set the buzzer as a screen data attribute by using the support tool.

When creating the screen data by using the support tool, set the buzzer as a screen attribute so that the buzzer will sound. When the screen in which this attribute has been set is displayed, the NT620S/620C will give the buzzer sound.

If the control by the PC and the display of the screen in which the buzzer attribute has been set are executed simultaneously, the priority is given to the control by the PC. Refer to the NT-series Support Tool Operation Manual (V028-E1-□).

### To Stop the Buzzer Sound

The buzzer sound can be stopped by the following operation.

- Control by the host
- Switch the screen to a screen which does not have a buzzer attribute.
- Press the touch switch to which the buzzer stop attribute has been set.

If a buzzer stop attribute has been set to a touch switch created on the screen in which the buzzer attribute has been set, such touch switch can be used to stop the buzzer sound.

To set a buzzer stop attribute for a touch switch, set the  control key function for the touch switch by using the input key function.

For the touch switch setting, refer to Section 4-7 “Touch Switches” (page 161).

### Types of the Buzzer Sounds

The following buzzer sounds can be set.

- Continuous sound: The buzzer continues to sound.
- Short intermittent sound: The buzzer sounds intermittently at 0.5 second intervals.
- Long intermittent sound: The buzzer sounds intermittently at 1 second intervals.

If two or more buzzer sound specifications are made from the host at the same time, the order of priority that determines which buzzer sound will be used is as follows: (1) continuous sound → (2) short intermittent sound → (3) long intermittent sound. If the continuous sound and short intermittent sound are specified at the same time, the continuous sound takes priority.

**Setting the Buzzer**

Use the memory switches to set whether or not the buzzer sounds when the buzzer sound has been instructed by the PC or with a screen attribute or when an error has occurred.

The factory setting is not fixed.

Set the buzzer sound by the menu operation from the System Menu as shown below.

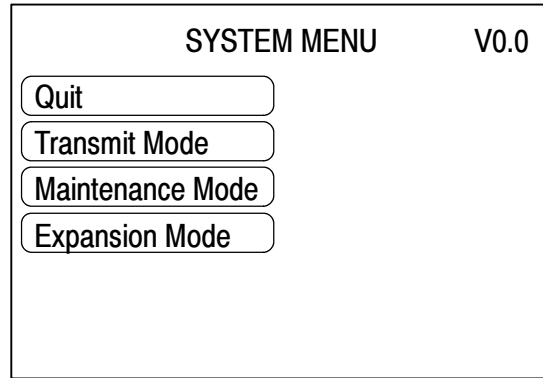

Select "Maintenance Mode".

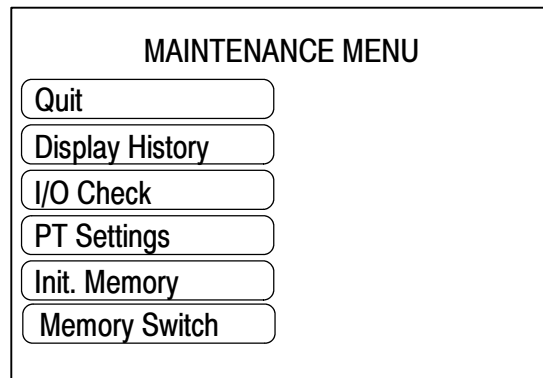

Select "Memory Switch".

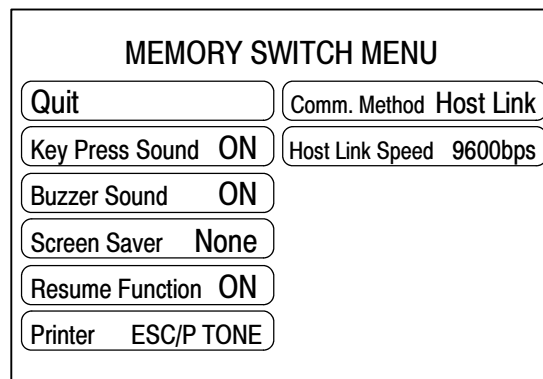

Each time the "Buzzer Sound" touch switch is pressed, the setting option "ON" alternates with "ERR ON", "OFF".

To set and quit the menu, press the "Quit" touch switch. The setting made last will be set and the display will return to the "MAINTENANCE MENU".

- OFF: The buzzer will not sound at all during the operation.
- ON: The buzzer will sound when a command from the PC is given, the screen attribute has been set, or an error has occurred.
- ERR ON: The buzzer will sound only when an error has occurred.

**Reference**

The buzzer will sound when “Buzzer check” is selected in the Maintenance Mode regardless of the buzzer setting.

### 3-8-3 Screen Saver Function (NT620S) / Backlight OFF Function (NT620C)

The NT620S/NT620C has a function that turns off the screen display if no operation is performed for a certain period of time to maximize the service life of the backlight and prevent the formation of an afterimage on the screen (in the case of the NT620C, the backlight is also switched off at the same time).

Continuous display of the same pattern for an extended time (as a guide, about 1 hour) will lead to the formation of an afterimage.

In order to prevent this, either use the screen saver function or periodically switch screens.

#### Redisplaying a Screen that has been Turned Off

After the screen has been turned off by the screen OFF/backlight OFF function it will be redisplayed if a touch switch is pressed, or if an instruction to switch the screen or redisplay the same screen is received from the PC (in the case of the NT620C, the backlight will also be turned back on at the same time). Changes in numerals or character-strings displayed on the screen will not cause the screen to be redisplayed.

#### Setting the Screen OFF/Backlight OFF Function

Use the memory switches to set whether or not the screen OFF/backlight OFF function is used, and the length of time that the screen is turned off if it is used.

The factory setting is not fixed.

**SYSTEM MENU** V0.0

Quit

Transmit Mode

Maintenance Mode

Expansion Mode

Select "Maintenance Mode".



**MAINTENANCE MENU**

Quit

Display History

I/O Check

PT Settings

Init. Memory

Memory Switch

Select "Memory Switch".

The "screen OFF/backlight OFF" switch is for the screen saver function in the case of the NT620S memory switches and for the backlight OFF function in the case of the NT620C memory switches.



**MEMORY SWITCH MENU**

Quit

Key Press Sound ON

Buzzer Sound ON

Screen Saver None

Resume Function ON

Printer ESC/P TONE

Comm. Method Host Link

Host Link Speed 9600bps

Each time the "Screen Saver" touch switch is pressed, the setting option will switch among "10 minutes", "1 hour", and "None".

To set and quit the menu, press the "Quit" touch switch. The setting made last will be set and the display will return to the "MAINTENANCE MENU".

- None: The Screen Saver function is not used. As long as no operation is performed, the same screen remains to be displayed.
- 10 minutes: The screen will be turned off when no operation has been performed for 10 minutes.
- 1 hour: The screen will be turned off when no operation has been performed for 1 hour.



**Caution** - Do not press touch switches carelessly while the backlight is off or while nothing is displayed on the screen. Otherwise the system may operate unpredictably. Only press touch switches after confirming system safety.

**Note** After images may remain if the same pattern is displayed for a long period. To prevent the formation of an afterimage, either use the screen saver function or periodically switch screens.

### 3-8-4 Resume Function

The NT620S/620C has a function to protect the contents of the memory table (value setting key input, data from the PC, etc.) from being erased even if the power to the NT620S/620C is shut off during operation. This function is called the resume function. Setting the resume function protects the memory table from being initialized even when the power is turned on or reset or when the mode is switched to the "RUN" mode by the System Menu operation.

The screen displayed before the power is turned off will be displayed again when the NT620S/620C is started next time.

If the "Init. Memory Table" is selected in Initialize Memory Menu from the Maintenance Mode Menu, the memory table will be initialized regardless of whether or not the resume function is set to ON or OFF. For the memory table initialization, refer to "Initializing Memory" (page 65).

**Note** If the voltage of the battery in the NT620S/NT620C gets too low, the contents of the memory tables cannot be saved even if the resume function is effective.

Use the memory switches to set whether or not the resume function is used. The factory setting is not fixed.

Set the resume function by using the menu operation from the System Menu as shown below.

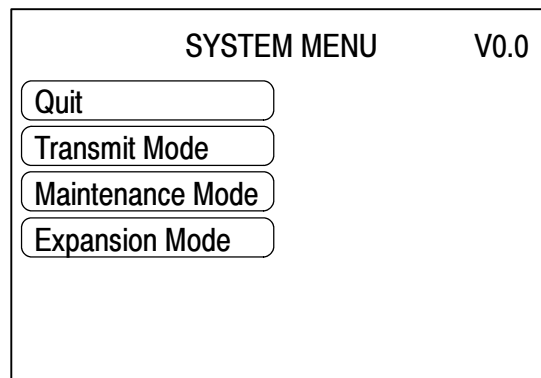

Select "Maintenance Mode".

**MAINTENANCE MENU**

Quit
Display History
I/O Check
PT Settings
Init. Memory
Memory Switch

Select "Memory Switch".



**MEMORY SWITCH MENU**

Quit	Comm. Method	Host Link
Key Press Sound ON	Host Link Speed	9600bps
Buzzer Sound ON		
Screen Saver None		
Resume Function ON		
Printer	ESC/P TONE	

Each time the "Resume Function" touch switch is pressed, the setting option "ON" alternates with "OFF".

To set and quit the menu, press the "Quit" touch switch. The setting made last will be set and the display will return to the "MAINTENANCE MENU".

- OFF: The resume function will be disabled and the memory table will be initialized when the power to the NT620S/620C is turned on or reset or when the mode is switched to the "RUN" mode.
- ON: The resume function will be enabled and the memory table will not be initialized. When the NT620S/NT620C starts operation, the contents of the memory tables are written to the allocated words in the PC.

### 3-8-5 Screen Printing Function

The NT620S/620C can print a hardcopy of the displayed screens onto a printer connected to the NT620S/620C. This function is called the screen printing function. The NT620S/620C will continue operating even when such a hardcopy is being printed.

However, since the screen print function shares the NT620S/620C memory with the pop-up window function (page 185), hard copies cannot be printed while a pop-up window is displayed.

For printer connection, refer to Section 2-9 "Connecting a Printer" (page 57).

#### Printing Screens

Screen printing can be performed by using a touch switch for which screen printing/interruption function is set or by giving a screen printing command from the PC.

- Using the touch switch

When creating screen data with the support tool, set the screen printing function to a touch switch. For details, refer to NT-series Support Tool Operation Manual (V028-E1-□).

Pressing the touch switch so set as to start hardcopy printing prints a hardcopy of the screen displayed. To interrupt the printing, press the touch switch to which hardcopy printing interruption is set.

- Giving instruction from the PC

Set up a PT status control area (PC → PT) and then start printing the screen.

For details, refer to Section 5-7 "NT620S/620C Status Control" (page 257).

However, printing of screen hardcopies may not be interrupted from the PC.

**Setting Screen Printing**

Set the type of the printer and a way of printing in the Memory Switch.

The factory setting is not fixed.

Screen printing by using the menu operation from the System Menu as shown below.

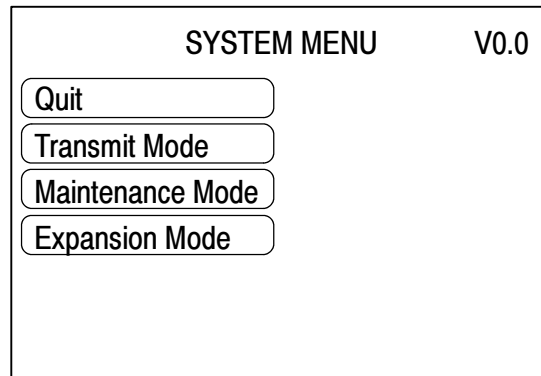

Select "Maintenance Mode".

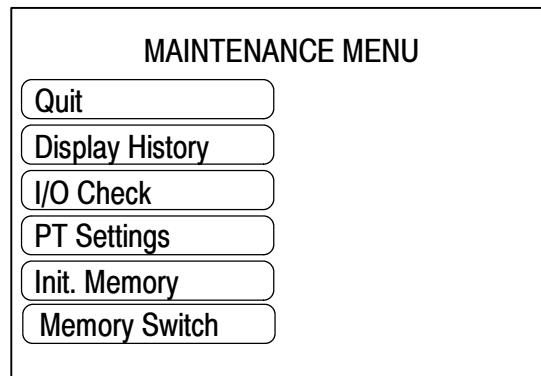

Select "Memory Switches".

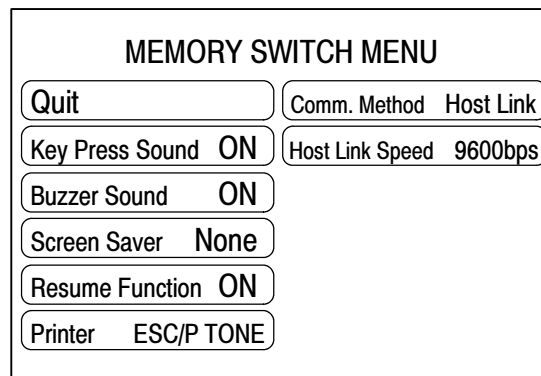

Each time the "Printer" touch switch is pressed, the next item in the applicable cycle of options below is selected:

For the NT620S:

"PR201H TONE"

"ESC/P TONE"

"PCL5 TONE"

For the NT620C:

"PR201H COL."

"ESC/P COL."

"ESC/P TONE"

"PCL5 TONE"

To set and quit the menu, press the "Quit" touch switch. The setting made last will be set and the display will return to the "Maintenance Mode" menu.

## [ NT620S ]

- ESC/P TONE: Specify this for a printer, such as the EPSON ESC/P Printer (24-pin), that conforms to the printer control standard ESC/P.
- PR201H TONE: A printer that emulates NEC's PC-PR201H can be used.
- PCL5 TONE: Hewlett Packard printers that conform to the PCL5 standard can be used.

## [ NT620C ]

- ESC/P COL.: Specify this for a printer, such as the EPSON ESC/P Printer (24-pin), that conforms to the printer control standard ESC/P. Hardcopies will be made in colors.
- ESC/P TONE: Specify this for a printer, such as the EPSON ESC/P Printer (24-pin), that conforms to the printer control standard ESC/P. Hardcopies will be made in monochrome with colors expressed by gray scale levels.
- PR201H COL.: A printer that emulates NEC's PC-PR201H can be used. Hard copies will be made in colors.
- PR201H TONE: A printer that emulates NEC's PC-PR201H can be used. Hard copies will be made in monochrome with colors expressed by gray scale levels.
- PCL5 TONE: Hewlett Packard printers that conform to the PCL5 standard can be used. Hard copies will be made in monochrome with colors expressed by gray scale levels.

## 3-9 System Maintenance

The NT620S/620C has self-maintenance functions, such as display history recording, I/O check and PT setting display. These functions are accessible mainly from the Maintenance Mode.

### 3-9-1 Using the Display History Recording Function

The display history recording function is used to record the display sequence and frequency of screens during operation. The data recorded can be displayed and confirmed on the system screen.

**Recording Display History** Display history is recorded in the following procedure:

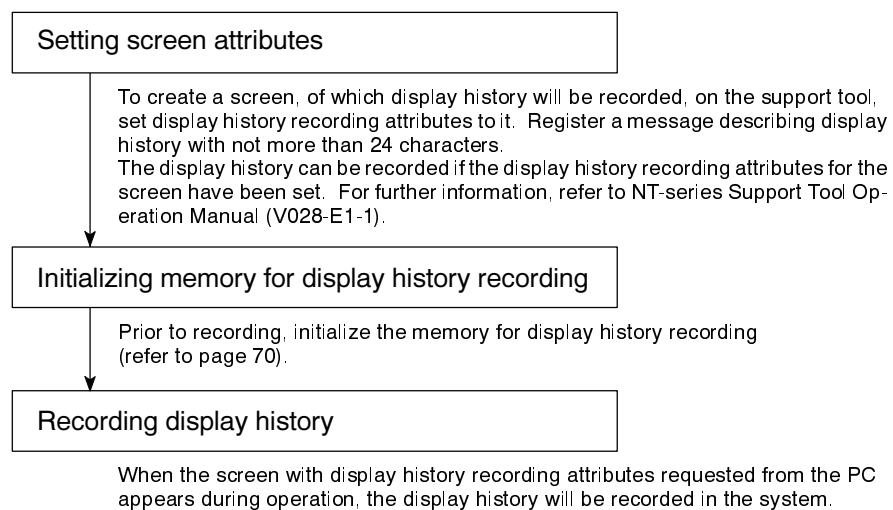

#### Display History Recording Format

Display history includes the following items related to the screen displayed:

- Screen number
- Date and time of display
- Message outlining screen data

#### Maximum Number of Screens to be Recorded

Up to 1023 screens can be recorded. The maximum number of recording times per screen is 255.

Since the data recorded is retained by the battery, it will not be lost even if the power to the system is turned off.

**Confirming Screen Data Recorded**

There are two ways to confirm screen data recorded: by the maintenance mode, and by displaying the screen by the display history recording function during operation.

Recorded data can be displayed in order of occurrence or frequency.

- In order of “occurrence”

Recorded data is displayed in order of occurrence.

Example: For NT620S

Screen#	(Year/Month/	Day	Hour: Mi)	( X )	Message	1/1
1	( 94/ 05/	30	23: 30)	( )	Coolant Error	<input type="button" value="End"/> <input type="button" value="↑"/> <input type="button" value="↓"/>
2	( 94/ 05/	31	02: 17)	( )	Motor Error	
8	( 94/ 05/	31	11: 05)	( )	Compressor Error	
2000	( 94/ 05/	31	21: 48)	( )	Emergency Stop	

- In order of “frequency”

Recorded data is displayed in order of display frequency with the accumulated number of times each screen has been displayed.

Example: For NT620S

Screen#	(Year/Month/	Day	Hour: Mi)	( X )	Message	1/1
8	( / /	:	)	( 255 )	Compressor Error	<input type="button" value="End"/> <input type="button" value="↑"/> <input type="button" value="↓"/>
2	( / /	:	)	( 20 )	Motor Error	
1	( / /	:	)	( 3 )	Coolant Error	
2000	( / /	:	)	( 1 )	Mergency Error	

For both order of occurrence and order of frequency, the number of entries that can be displayed on one screen is 23 in the case of the NT620S and 27 in the case of the NT620C.

To take a look at data that is not on the display, press the  or  key on the touch panel.

When no screen data is recorded, the message “History Record Not Found” appears, and the screen returns to the “History Record” after about two seconds.

- Confirming recorded screen data by the maintenance mode

Confirm the display history by using the menu operation from the System Menu as shown below.

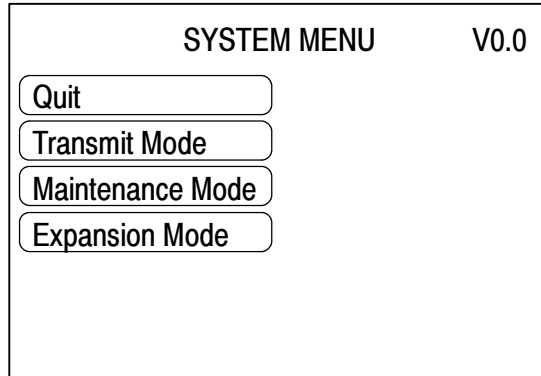

Select "Maintenance Mode".

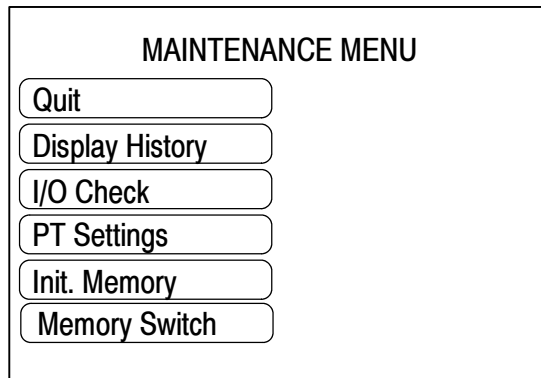

Select "Display History".

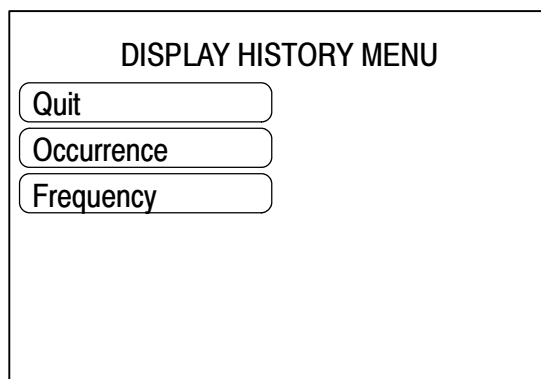

Select "Occurrence" or "Frequency".

The registered data will be displayed in accordance with the selected method.

Press the "Quit" touch switch on the touch panel. The screen will return to the "DISPLAY HISTORY MENU".



- Confirming recorded screen data during operation

Screens No. 1997 and No. 1998 are for displaying recorded screen data.



Either screen will be displayed according to the data display order selected.

Screen No. 1997: In order of occurrence

Screen No. 1998: In order of frequency

---

**Note**

- Screens No. 1997 and No.1998 are reserved for recorded screen data display. They are unavailable for any other purpose.
- When recorded screen data is displayed during operation, the touch switches that can scroll up or down the screen do not appear. Create  and  touch switches as illustrated below in the right-end 40-dot wide column (for two touch switches) on the screen in advance.

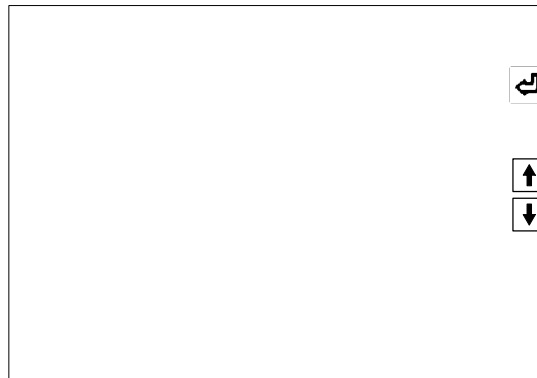

### 3-9-2 I/O Check

The I/O operations for the following items of the NT620S/620C are checked by the I/O check function.

- Touch Switch
- Communication I/F
- LCD/EL
- Buzzer
- LED
- Battery
- DIP-Switch
- Screen Memory
- Printer I/F
- Calender & Clock
- Backlight (NT620C only)

#### Checking the Touch Switches

Execute a touch switch check by the menu operation from the System Menu as shown below.

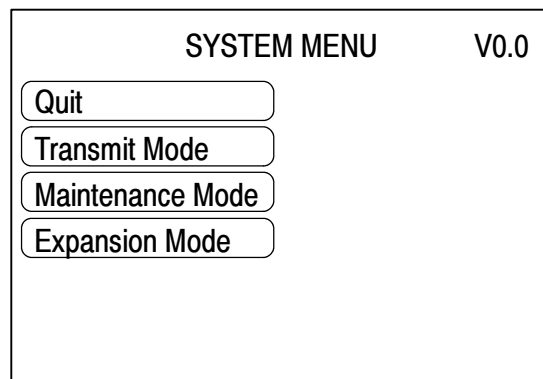

Select "Maintenance Mode".

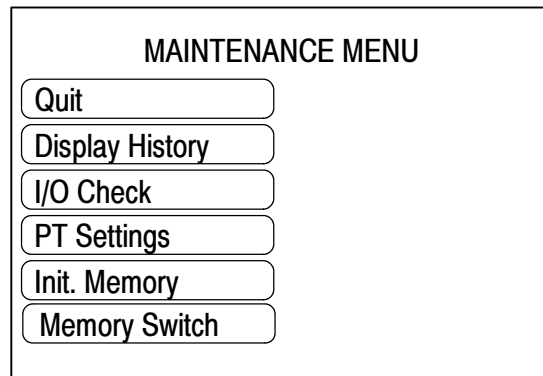

Select "I/O Check".



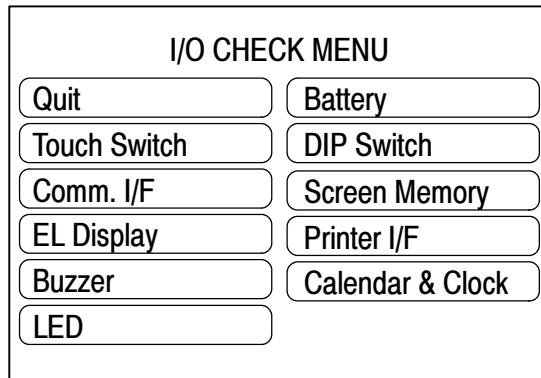

Select "Touch Switch".

- NT620S

A checking screen, which shows switches of 16 rows and 32 column, will be displayed.

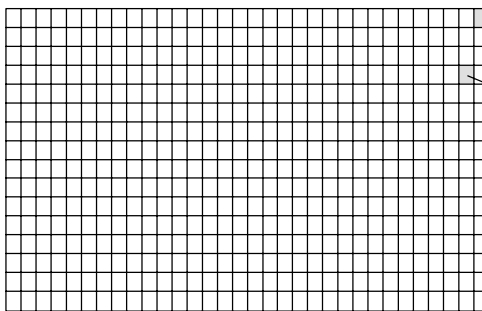

This touch switch is to exit the touch switch checking screen. Its color is different from that of the other switches.

The touch switch is normal if it is highlighted while pressed.

- NT620C

A checking screen, which shows switches of 24 rows and 32 column, will be displayed.

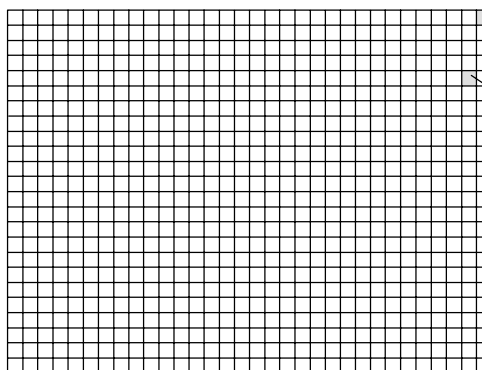

This touch switch is to exit the touch switch checking screen. Its color is different from that of the other switches.

The touch switch is normal if it is highlighted while pressed.

- Press a touch switch on the screen. If the touch switch is highlighted while it is pressed, the touch switch is normally functioning.
- After the check is completed, press the touch switch in the upper right corner. The screen will return to the "I/O CHECK MENU".

**Reference**

If memory switch setting for the key press sound has been made for ON, the key press sound will be made when a touch switch is pressed. The number of pressed touch switch will not be notified to the PC.

**Checking the Communications with the Support Tool**

Execute a NT620S/620C-to-support tool communication check by the menu operation from the System Menu as shown below.

The NT620S/620C uses one connector for connection to both the support tool and the PC. If it is connected to other equipment, remove the connecting cable from the connector and connect the cable to the connector for the support tool. Then perform a communication check.

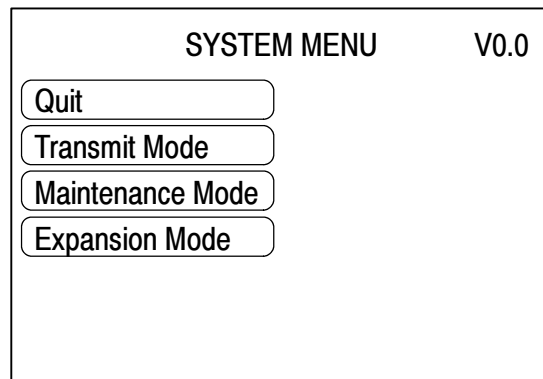

Select "Maintenance Mode".

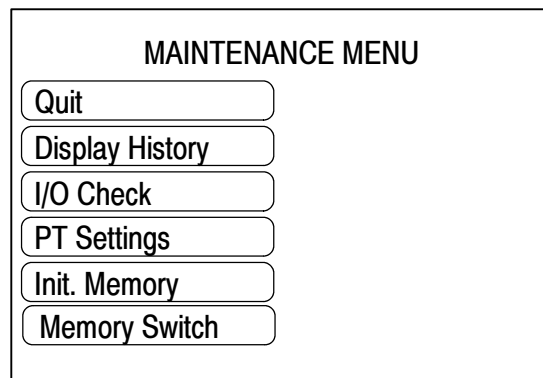

Select "I/O Check".

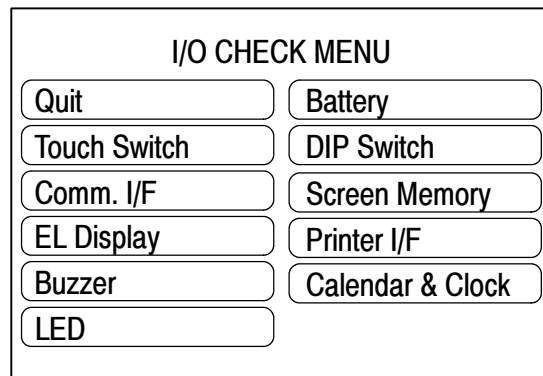

Select "Comm. I/F".



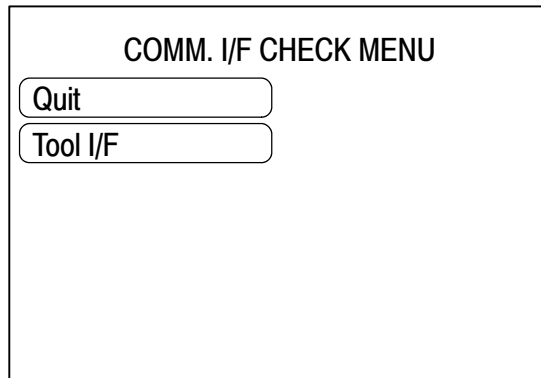

Select "Tool I/F".

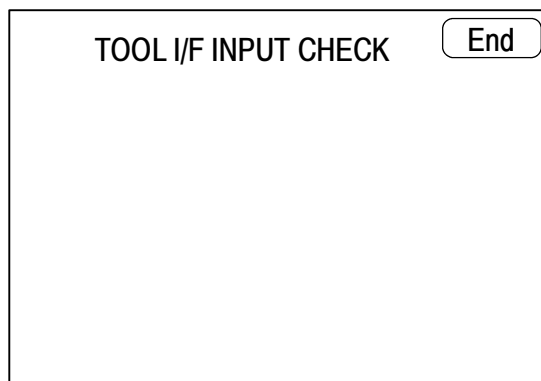

The data received from the connected support tool are displayed in hexadecimal numbers.

- When the check is finished, press the "End" touch switch. The "I/O CHECK MENU" will be redisplayed.

Checking the LCD/EL display

Check the NT620S/620C LCD/EL display by using the menu operation from the System Menu as shown below (in the case of the NT620S, "EL Display" is displayed and in the case of the NT620C, "LCD Display" is displayed).

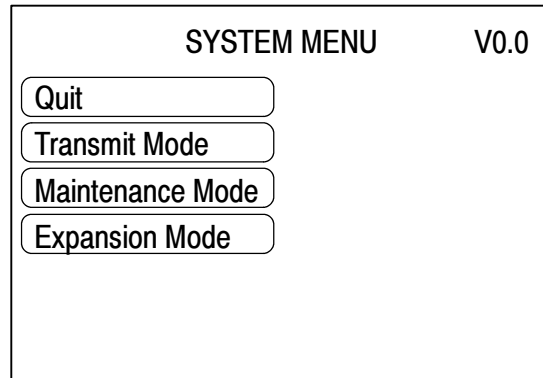

Select "Maintenance Mode".

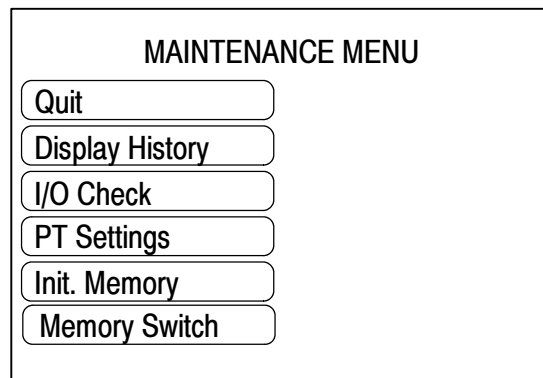

Select "I/O Check".

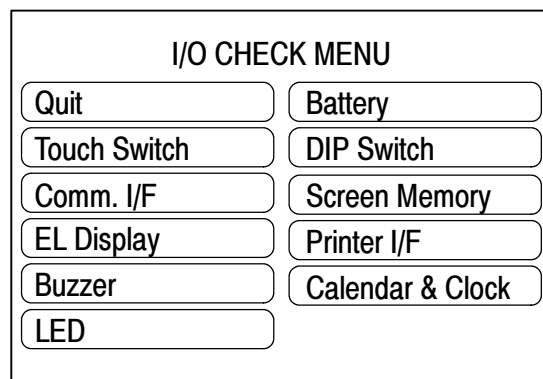

Select "LCD Display" or "EL Display".

(The example to the left shows the NT620S screen.)

- Dots (the points that make up the screen) are displayed one by one starting at the top left of the screen. In the case of the NT620C, the check is performed for each color (in the order black → blue → magenta → white → yellow → green → black). If all the dots are displayed successfully, the display is cleared and the "I/O CHECK MENU" is redisplayed.
- To discontinue a screen display check, press the touch switch at the top right corner of the screen.

**Checking the Buzzer**

Check the NT620S/620C buzzer by using the menu operation from the System Menu as shown below.

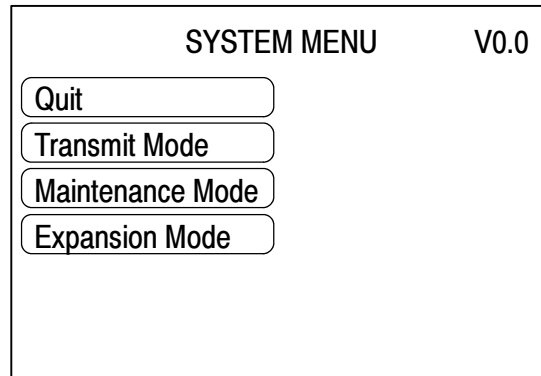

Select "Maintenance Mode".

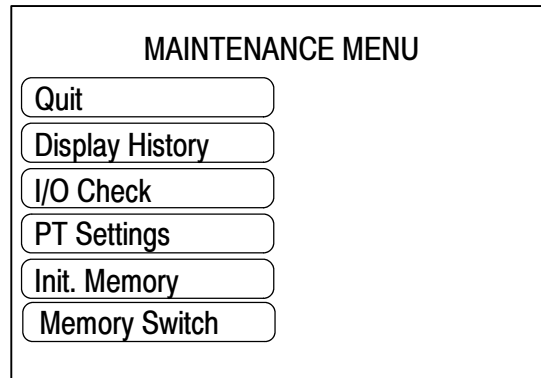

Select "I/O Check".

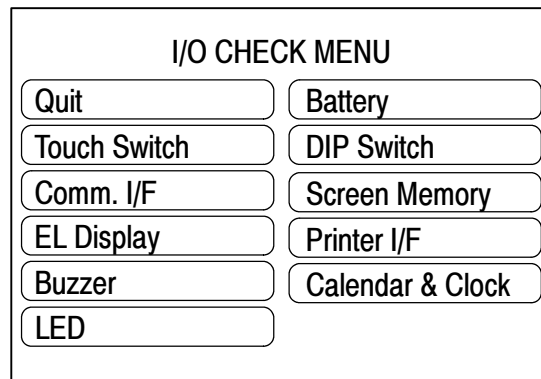

Select "Buzzer".

- If the buzzer function is normal, the continuous buzzer sound will be made.
- To stop the buzzer sounding, press the "Buzzer" touch switch again.

**Reference**

Though memory switch setting for the buzzer has been made for OFF, the buzzer will sound when the buzzer check is executed.

**Checking the LED**

Check the LED by using the menu operation from the System Menu as shown below.

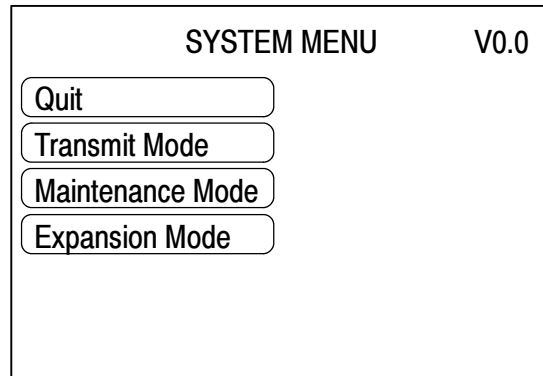

Select "Maintenance Mode".

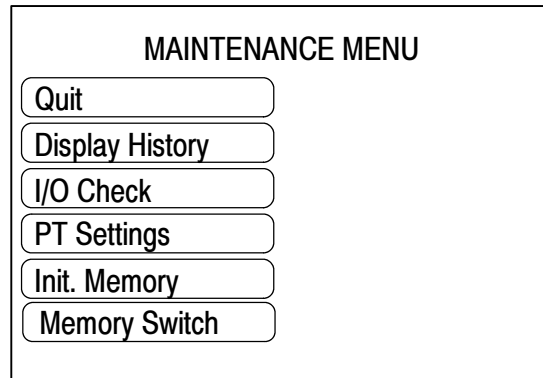

Select "I/O Check".

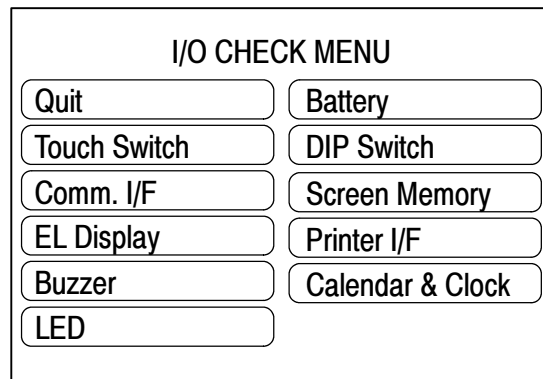

Select "LED".

The "RUN" LED on the front face of the NT620S/620C will flash alternately green and red. The "POWER" LED will remain lit.

- To quit the LED check, press the "LED" touch switch again.



Checking the Battery Voltage

Check the battery voltage by using the menu operation from the System Menu shown below.

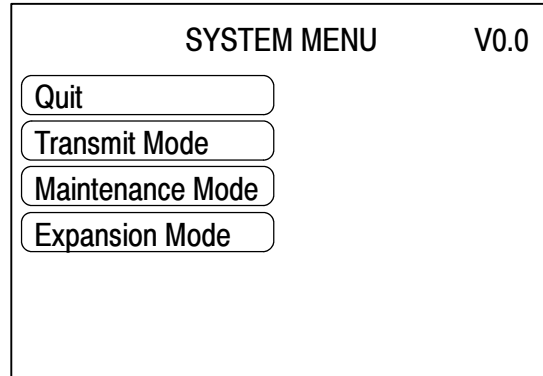

Select "Maintenance Mode".

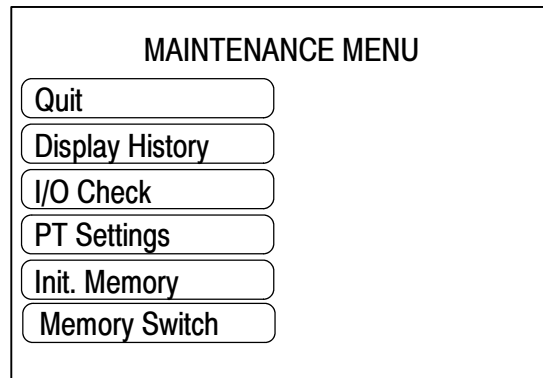

Select "I/O Check".

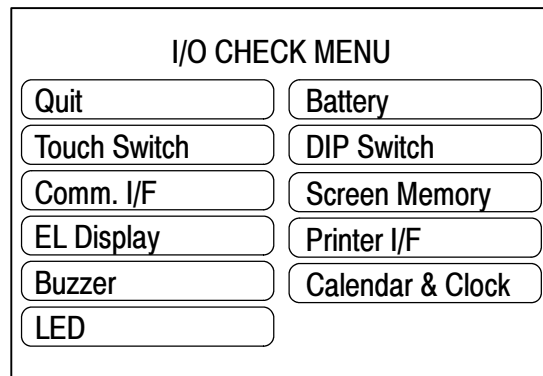

Select "Battery".



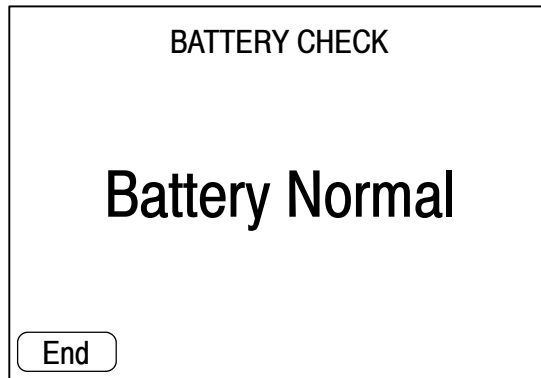

- After checking the screen message, press the “End” touch switch. The “I/O CHECK MENU” will be redisplayed.

**Checking the NT620S DIP Switch Settings**

Display the NT620S/620C DIP switch settings by using the menu operation from the System Menu as shown below.

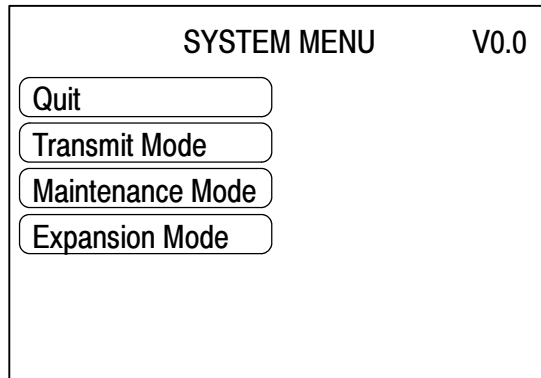

Select “Maintenance Mode”.

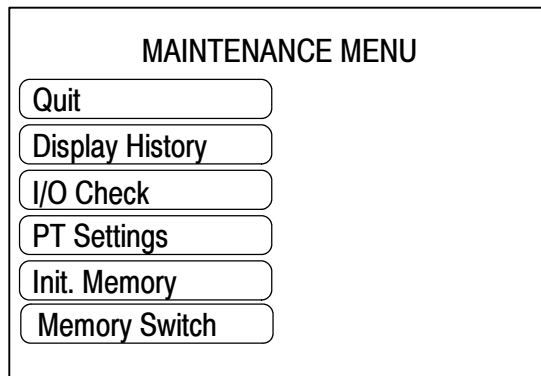

Select “I/O Check”.



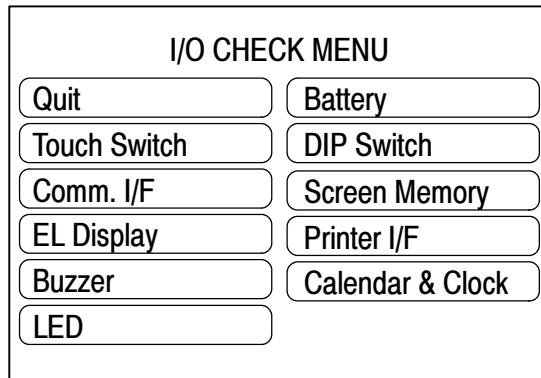

Select "DIP Switch".

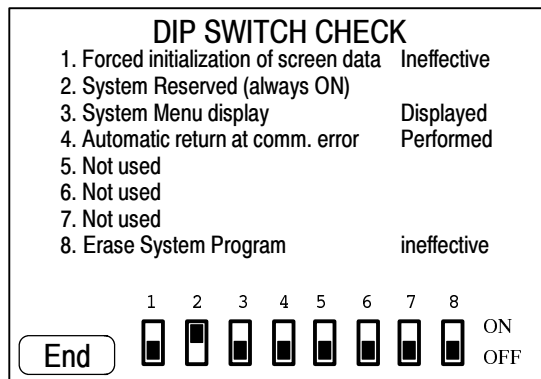

- After checking the DIP switch statuses, press the "End" touch switch.

**Note**

Always switch off the power to the NT620S/NT620C before changing DIP switch settings.

Checking the Screen Memory

Check the screen memory by using the menu operation from the System Menu shown below.

**Note** When a screen memory check is performed, the screen memory is initialized and all the screen data is cleared. Check that the data has been backed up by using the support tool.

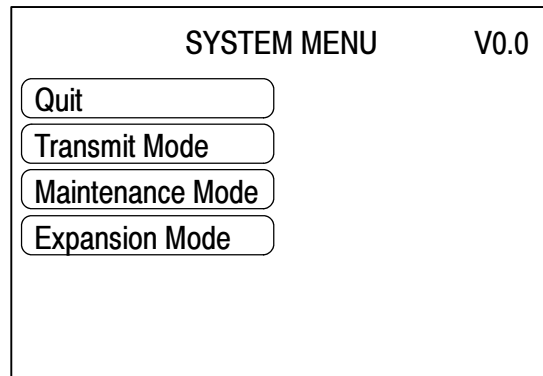

Select "Maintenance Mode".

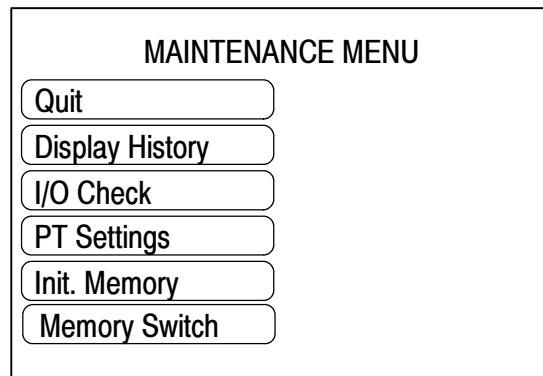

Select "I/O Check".

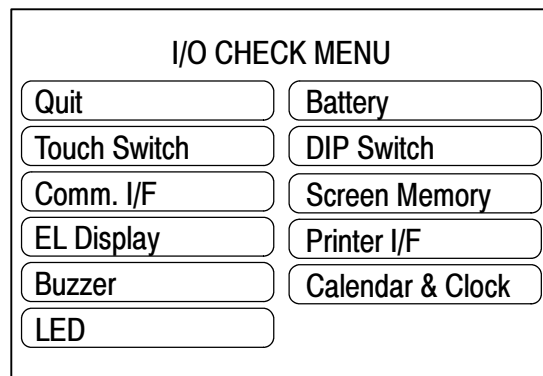

Select "Screen Memory".



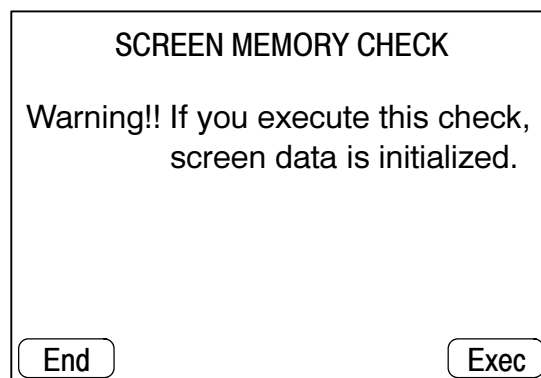

Press "Exec".

- If "End" is pressed without having pressed "Exec", the check is not executed. The screen memory check starts. While the check is in progress, the message "Checking" is displayed.
- If the check is completed normally, the message "Memory Normal" is displayed.
- To quit the check, press the "End" touch switch. The "I/O CHECK MENU" will be redisplayed.
- If the message "Memory Trouble" is displayed, it indicates that the life of the screen data memory has expired or that there may be a hardware fault. Initialize the screen data memory and perform the test again. If the same error message is displayed again, contact your OMRON service center.

Checking the Printer Interface

Check communication with the printer by using the menu operation from the System Menu shown below.

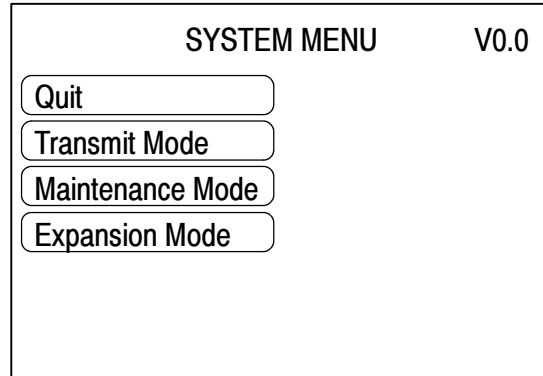

Select "Maintenance Mode".

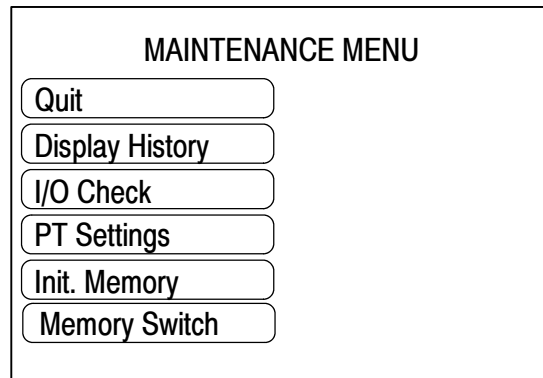

Select "I/O Check".

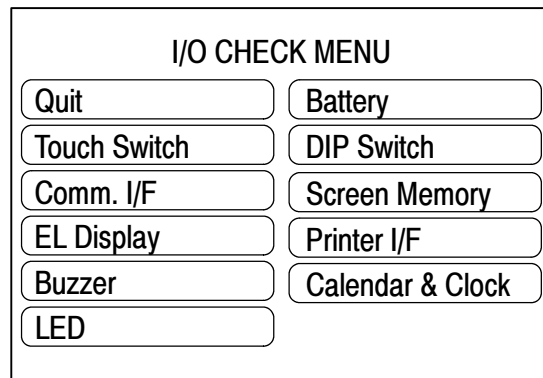

Select "Printer I/F".



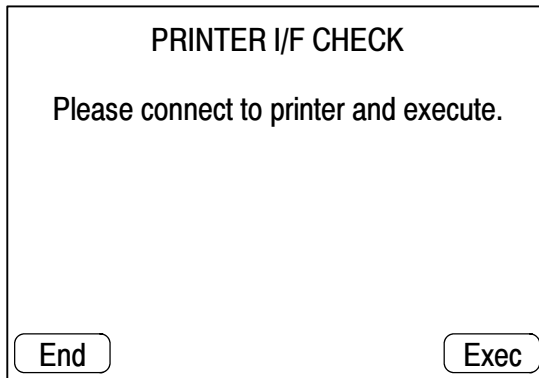

Press "Exec".

"Printer Interface Check" will be printed out at the connected printer.

- On completion of the check, the message "Finish Check" will be displayed.
- On confirming the result, press the "End" touch switch. The "I/O CHECK MENU" will be redisplayed.

### Checking and Setting the Calendar and Time

Check the setting of the internal clock function by using the menu operation from the System Menu as shown below. Other setting screens can then be displayed to set the date and time.

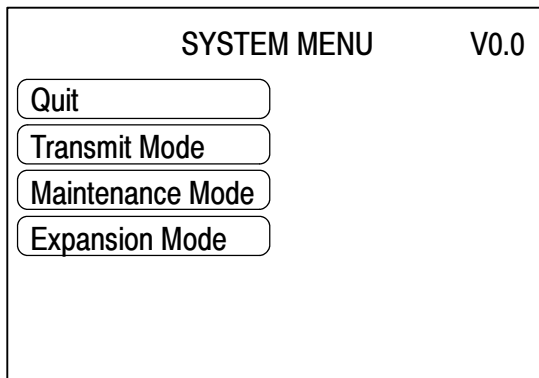

Select "Maintenance Mode".

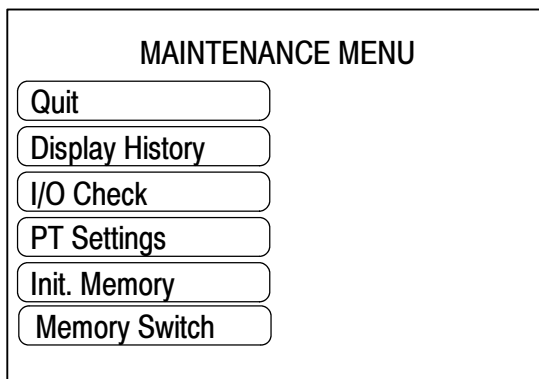

Select "I/O Check".



**I/O CHECK MENU**

Quit	Battery
Touch Switch	DIP Switch
Comm. I/F	Screen Memory
EL Display	Printer I/F
Buzzer	Calendar & Clock
LED	

Select "Calendar & Clock".



**CALENDAR & CLOCK CHECK**

Fri    <sup>month</sup> 05    -    <sup>day</sup> 19    -    <sup>year</sup> '95  
       <sup>hour</sup> 13    :    <sup>min</sup> 26    :    <sup>sec</sup> 47

If you set Calendar & Clock, push [Set] please.

End
Set

- After checking the date and time settings, press the "End" touch switch. The "I/O CHECK MENU" will be redisplayed.
- To change the existing setting, press the "Set" touch switch.

**CALENDAR & CLOCK SET**

Fri    <sup>month</sup> 05    -    <sup>day</sup> 19    -    <sup>year</sup> 95  
       <sup>hour</sup> 13    :    <sup>min</sup> 26    :    <sup>sec</sup> 47

Push touch switch and set time,  
after that push [Save Exit] please.

If you will cancel, push [Cancel] please.

Cancel
Save Exit

The "CALENDAR & CLOCK SET" screen will be displayed (it will display the time at the instant the "Set" touch switch was pressed).

Each of the digits of the date, day, and time settings is a touch switch and the value it displays can be changed incrementally ("0" → "1" → "2" → ...) by pressing the touch switch (note there is no carry over to the next higher digit if a full cycle is completed).

Specify the date, day of the week, and time. Note that no strict input check is performed: make sure that the settings are correct.



- On completing setting, press the “Save Exit” touch switch. The calendar and time specifications will be set and the CALENDAR & CLOCK CHECK screen will be redisplayed.
- To cancel the settings, press the “Cancel” touch switch. This will redisplay the CALENDAR & CLOCK CHECK screen without setting the specified date and time.
- Calendar and clock setting can also be executed by operation from the Tool Settings screen of the support tool, or by using numeral memory table operations. For details on the setting procedure when using the support tool, refer to the NT-series Support Tool Operation Manual (V028-E1-□), and for details on the setting procedure using numeral memory tables, refer to 5-6 “Clock Function” (page 251).

### Checking the backlight (NT620C)

Check the NT620C backlight by following the menu operation from the System Menu described below. Note that the NT620S, which has an EL display, has no backlight check function.

Select “Maintenance Mode”.



Select “I/O Check”.



Select “Backlight”.

- If the backlight is functioning normally, it flashes on and off.
- On completion of the check, press the “Quit” touch switch. The display returns to the “I/O CHECK MENU”.

### 3-9-3 Checking the PT Setting Status

Display the NT620S/620C settings by using the menu operation from the System Menu as shown below.

SYSTEM MENU		V0.0
Quit		
Transmit Mode		
Maintenance Mode		
Expansion Mode		

Select "Maintenance Mode".



MAINTENANCE MENU	
Quit	
Display History	
I/O Check	
PT Settings	
Init. Memory	
Memory Switch	

Select "PT Settings".



PT SETTINGS		End
PT Control Area	DM 0000	
PT Notify Area	DM 0010	
Comm. Method	Host Link	
Host Link Speed	9600bps	
Automatic Reset	Performed	
Resume Function	Effective	

- The current NT620S/620C setting status will be displayed.
- Pressing the "End" touch switch will exit the "PT SETTINGS" display and cause the NT620S/620C to return to the "MAINTENANCE MENU".

---

## SECTION 4

### NT620S/620C Functions

This section describes the functions of the NT620S/620C.

4-1	Creating and Transmitting Screen Data	118
4-1-1	Setting the Support Tool for Use with the NT620S/620C	118
4-1-2	Creating Screen Data	119
4-2	Outline of Functions	124
4-2-1	NT620S/620C Screen	124
4-2-2	Color Display (NT620C Only)	126
4-2-3	Characters and Figures which can be Displayed	128
4-2-4	Communication with the PC	133
4-3	Screen Display	135
4-3-1	Classification of Screens	135
4-3-2	Screen Attributes	138
4-4	Memory Tables	139
4-4-1	Character-String Memory Table	139
4-4-2	Numeral Memory Table	142
4-4-3	Bit Memory Table	143
4-5	Graphs	145
4-5-1	Bar Graph Functions	145
4-5-2	Trend Graph Setting	148
4-5-3	Broken Line Graph Setting	153
4-6	LAMP	157
4-6-1	Normal LAMP Functions	157
4-6-2	Image Library LAMP Setting	160
4-7	Touch Switches	161
4-7-1	Functions of Touch Switches	162
4-7-2	Stand Alone Functions	165
4-7-3	Input Key Function	167
4-7-4	COPY Key Function	168
4-7-5	Cursor Moving Key Function	168
4-7-6	SCREEN PRINT Key Function	169
4-8	Numeral Setting	170
4-8-1	Numeral Setting Functions	170
4-8-2	Type of Numeral Setting	172
4-8-3	Ten-Key Creation	173
4-8-4	How to Use Ten-Key Type	175
4-8-5	How to Use a Thumb Wheel Type	179
4-8-6	Setting Items for Numeral Setting	180
4-9	Character-String Setting	182
4-9-1	Functions of Character-String Setting	182
4-10	Pop-Up Window Function	185
4-10-1	Functions of Pop-Up Windows	185
4-10-2	Opening and Closing Windows	187
4-10-3	Temporary Input Fields	189
4-11	Alarm List & History Display Functions	192
4-11-1	Alarm List Display	192
4-11-2	Displaying the Alarm History	196

## 4-1 Creating and Transmitting Screen Data

This section describes briefly the support tool settings required for creating screen data and the screen data creation procedure.

**Reference** For the details of the support tool and screen data creation, refer to the “NT-series Support Tool Operation Manual” (V028-E1-□).

### 4-1-1 Setting the Support Tool for Use with the NT620S/620C

To create the screen data for the NT620S/620C, make settings with the support tool for use with the NT620S/620C.

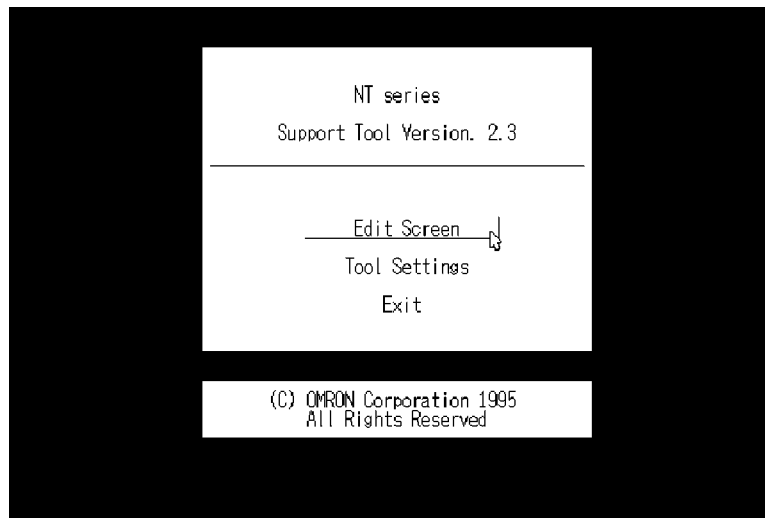

Select “Tool Settings”.

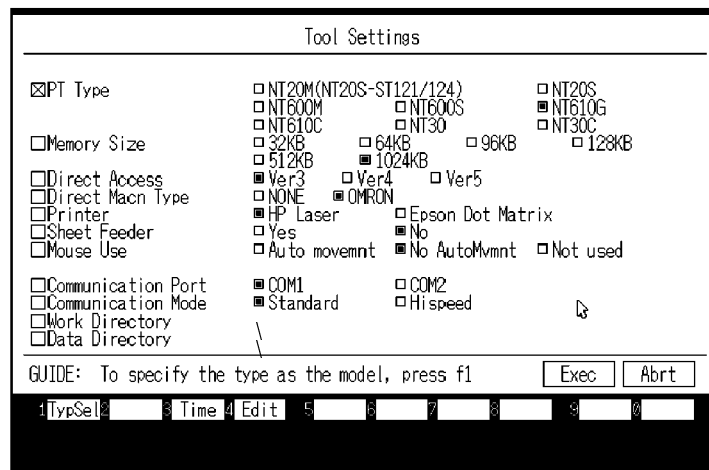

To create the NT620S/620C screen data, make settings in the “Tool Settings” screen as follows.

#### NT620S

- NT Model : 610G (There is no “620S” setting.)
- Memory Size : 512 KB
- Direct Access : Ver.4

#### NT620C

- NT Model : 610C (There is no “620C” setting.)
- Memory Size : 1024 KB
- Direct Access : Ver.4

#### Note

Since the NT620S and NT620C are, from the standpoint of functions, almost identical to the NT612G and NT610C, they do not have their own “NT Model” setting. Make the following settings for these two models:

NT620S : “610G”

NT620C : “610C”

## 4-1-2 Creating Screen Data

### Screen Data Creation Method

The screen data is created by using the support tool. The support tool registers the screen data used with one NT620S/620C to one file.

Screen data can be created by one of the following three methods:

- creating a new file;
- editing an existing file;
- reading and editing selected screens from an existing file.

### Screen Data Creation Procedure

The following gives the basic screen data creation procedure. Required settings and reference pages are given for each step of the procedure.

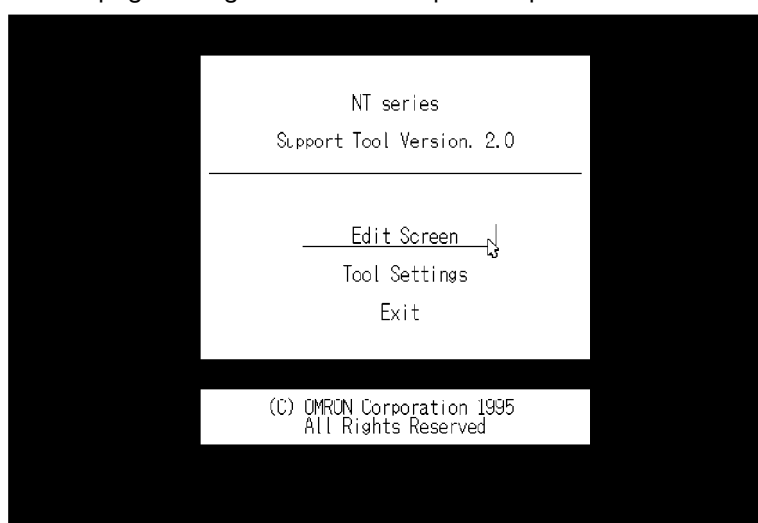

- á Select “Tool Settings” in the Main Menu to display the “Tool Settings” screen. Settings of NT model, memory size, direct connection, etc. are made in this screen. Refer to “Setting the support tool for use with the NT620S/620C” on the previous page.



Select "Edit Screen".

FileName	Title
NEW_FILE	Creation of New File
INPT_SCR	For Line Input
PROC_B	Process control backup
PROC_C	Production Qty Check
SAMPLE	
INPT_SCR	For Line Input
PROC_B	Process control backup
PROC_C	Production Qty Check
PROC_CTL	For process A

.Esc Exit to Main Menu	
NT610G	Ver 3.0
Direct	OMRON
Num. Mem. Tabs	1000
Str. Mem. Tabs	1000
DAC func.	No
	0.00KB

á Select a file used for storing the screen data for the NT620S/620C in the "File List" screen.

To create a new file, select "NEW FILE".

To edit an existing file, select a file to edit.

Select "NEW FILE" and press [Enter]. Enter filename on completion of creation.



Select "Screen Creation".

No.	Status	Comment
1		
2		
3		
4		
5		
6		
7		
8		
9		
10		
11		
12		
13		
14		
15		
16		

.Tab Specified Page
Space Mark/Unmark
Home Unmark All
Shift+Home Mark/Unmark All
.Esc Select File
Hist. [ ]
0Byte

Select a screen number to edit in the selected file in the "Scr list" screen.

However, before selecting the screen number, the PT status control area and PT status notify area must be set by referring to the sections specified below.

To read the screen data from other file, press the [F5] (Read) function key.

While in the “Scr list” screen, press the [F10] (Next) key, and then, the [F2] (Direct) key to display the “Direct Connection Data Setting” window in which the head words in the PC used to allocate the following areas.

- PT status control area: Section 5-7 “NT620S/620C Status Control” (page 257)
- PT status notify area: Section 5-8 “Notification of the Operating Status to the PC” (page 263)
- Numeral memory table: 4-4-2 “Numeral Memory Table” (page 142)
- Character-string memory table: 4-4-1 “Character-String Memory Table” (page 139)
- Bit memory table: 4-4-3 “Bit Memory Table” (page 143)

Pressing [F4] (Attrib) on the “Scr list” screen enables the screen attributes to be set in the Help Message area. The following screen attributes can be set:

- Buzzer: None, Cont (continuous sound), Long (long intermittent sound), Shrt (short intermittent sound)
- History: No, Yes
- Keypad: System, User
- Back Col

Back Col. (background color) can only be set when using an NT620C.



Select a screen number and press [Enter].



Create screen data in the Edit screen of the support tool. Data of one screen can be created by registering (laying out) the following display elements and attributes on the screen.

- Fixed display:
  - Input characters and graphics.
  - ..... Section 4-2-3 “Characters and Figures which can be Displayed” (page 128)

- Numeral display:  
Specify the numeral memory table number and display method.  
.....“Numeral Memory Table” (page 142)
- character-string display:  
Specify the character-string memory table number and display method.  
..... “Character-String Memory Table” (page 139)
- Lamp:  
Specify allocated bits. .... Section 4-6 “Lamps” (page 157)
- Touch switch:  
Specify allocated bits for control and notification.  
..... Section 4-7 “Touch Switches” (page 161)
- Graph  
Specify the type of graph, numeral memory table number, and display method.  
..... Section 4-5 “Graphs” (page 145)
- Input Setting  
Specify the numeral/character-string memory table number.  
..... Section 4-8 “Numeral Setting” (page 170)  
..... Section 4-9 “Character-String Setting” (page 182)
- Image & Library  
Specify the image/library code number  
..... Section 4-2-3 “Characters and Figures Which can be Displayed” (page 128)
- Alarm  
Specify the type of alarm, bit memory table number, and display method.  
..... Section 4-11 “Alarm List & History Display Functions” (page 192)



[Exiting the Edit screen]

Return to the “Scr list”.

The screenshot shows a terminal window with the title "[NEW\_FILE] Scr list NT610G-V3-0 1024KB". The main area contains a table with columns for No., Status, Comment, and Padn/PaUp. The table lists screens 1 through 16. Screen 1 is a Backup screen (B F), screens 2-4 are Production Qty Disp. (C), screen 5 is Production Rat. Disp. (C), screen 6 is No. 1 Press Monitor (E), screen 7 is No. 2 Press Monitor (E), and screen 8 is Conveyor Line 1. A mouse cursor is pointing at the right side of the table. To the right of the table is a "Screen Selection" panel with a "Help Message" section. The help message lists keyboard shortcuts: Tab for Specified Page, Space for Mark/Unmark, Home for Unmark All, Shift+Home for Mark/Unmark All, and Esc for Select File. Below the help message is a "Hist." field with brackets and "0Byte". At the bottom of the screen is a command bar with options: 1 Copy, 2 Delete, 3 Print, 4 Attrib, 5 Read, 6 Comment, 7 Image, 8 Co/Ovl, 9 Mark, 0 Next.

No.	Status	Comment	Padn/PaUp
1	B F	Backup screen	
2	C	Production Qty Disp.	
3	C	Production Qty Disp.	
4	C	Production Rat. Disp.	
5	E	Production Qty Disp.	
6	E	No. 1 Press Monitor	
7	E	No. 2 Press Monitor	
8		Conveyor Line 1	
9			
10			
11			
12			
13			
14			
15			
16			

If you want to create or modify another screen, select the screen number.





[To the File Selection]

Enter filename to newly created screen data.

Return to the "File List".

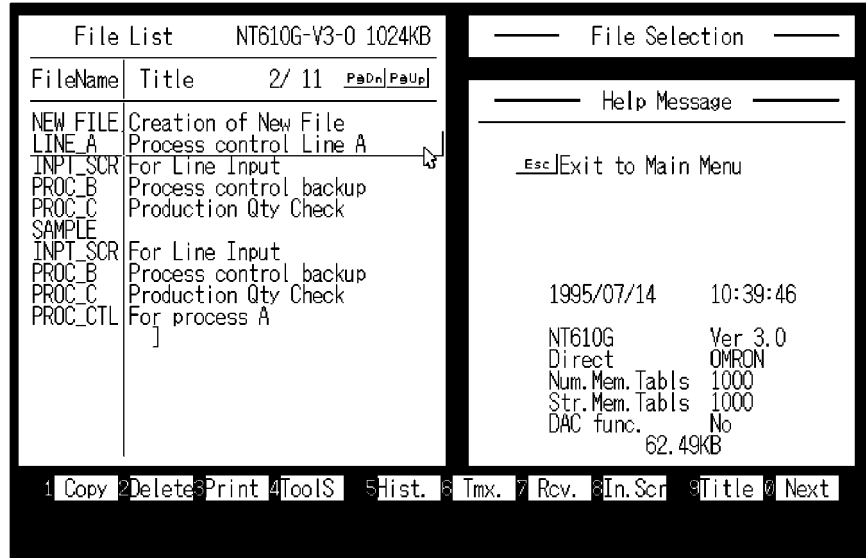

- Pressing the [F8] (In.Scr) key on the "File Selection" screen allows you to set the NT620S/NT620C memory switches (the settings are actually made when the screen data is transmitted).

**Transmitting Screen Data to the NT620S/620C**

Transmit the screen data created by using the support tool to the NT620S/620C screen data memory.

Connect the NT620S/620C to the support tool and set the NT620S/620C to Transmit Mode. Then, press the [F6] (Transmit) key in the "File List" screen to transmit the created screen data to the NT620S/620C.

For the connection procedure to the support tool, refer to Section 2-3 "Connecting to the Support Tool" (page 29). For the transmission of the screen data, refer to Section 3-6 "Registering the Screen Data" (page 80).

## 4-2 Outline of Functions

### 4-2-1 NT620S/620C Screen

This section gives the outline of the screen which is the basis of all NT620S/620C functions.

For specific operation procedure such as screen switching, refer to Section 4-3 "Screen Display" (page 135).

The screen data displayed on the screen is created using the support tool, which is installed in a personal computer. Created screen data is registered in the screen data memory of the NT620S/NT620C. For details on screen data registration, see 3-6 "Registering the Screen Data" (page 80).

#### Composition of the Screen

The NT620S screen is composed of horizontal 640 dots x vertical 400 dots. The NT620C screen is composed of horizontal 640 dots x vertical 480 dots. Each dot is set by the combination of the X (horizontal) and Y (vertical) coordinates. The origin of coordinates (0, 0) is set at the top left corner of the screen.

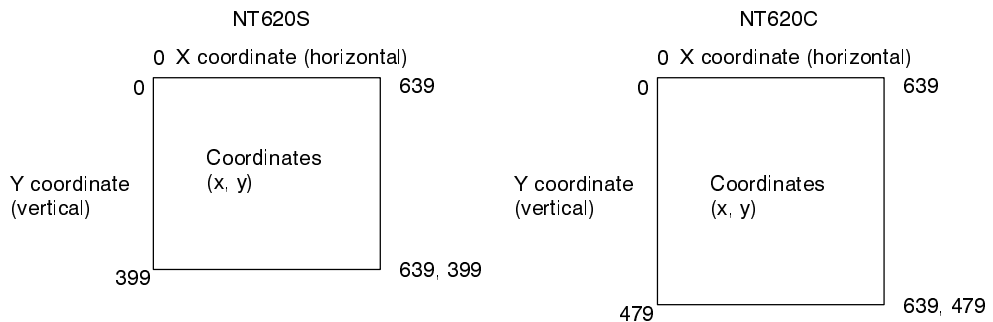

#### Display Elements

The screen can display the following elements. Each element is called a display element.

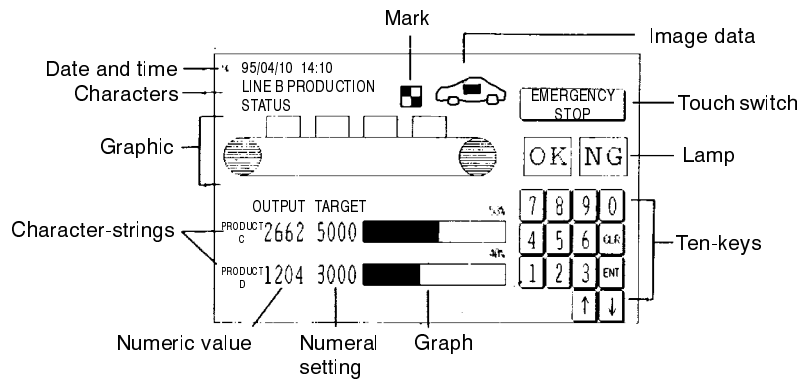

**Screen Management**

All screens displayed on the NT620S/620C are managed by their screen numbers.

A screen number can be assigned at the time of the creation of a screen by the use of the support tool. Up to 2000 screens can be created, and screen numbers from 1 to 2000 can be given to each of them as desired. The screen number is very helpful in switching the screen being displayed to a desired one from the host, or in specifying the screen to be displayed at the startup of the system (initial display screen).

**Special Screen Numbers**

Screens No. 0 and No. 1997 through No. 1999 are kept for the following special purposes:

- Screen No. "0"

Screen No. 0 is reserved with the system as the no-display screen. Select this screen when there is no need to display data on the screen.

- Screen No. "1997"

Screen No. 1997 is reserved with the system as the screen for History record in order of occurrence. Select this screen to display screen data in order of occurrence (available only with direct connection).

- Screen No. "1998"

Screen No. 1998 is reserved with the system as the screen for History record in order of frequency. Select this screen to display screen data in order of frequency.

- Screen No. "1999"

Screen No. 1999 can be defined as the "Connecting to host" screen. Without registering this screen, a screen with the message "Connecting To Host" automatically appears when the power is turned on, or the mode is shifted to operation.

The screens numbered 1900 through 1979 can be used as window screens for pop-up windows. If you do not want to use them as window screens, they can be used as ordinary screens.

**Note**

---

Screens No. 1980 through No. 1996 are intended to be used for extension functions. If they are used as user screens, it will not be possible to use extension functions.

---

## 4-2-2 Color Display (NT620C Only)

The NT620C can display the entire screen and screen elements, such as characters and graphics, in eight different colors. Specify a color as an attribute for each display element when creating a screen on the support tool.

The NT620S is not capable of color display.

### Available Colors

The following eight colors can be selected:

Red, green, blue, yellow, magenta, cyan, white, black

The four color combinations below are exclusive ORed. The combination of two exclusive ORed colors means that if the color of a display element is the same as that of the background, it will be displayed in a different color.

Yellow, for example, is exclusive ORed with blue.

Red ↔ Cyan Green ↔ Magenta Blue ↔ Yellow White ↔ Black

The following display elements are displayed in the above combinations of colors:

- Input area display frame and background colors of numeral and character-string setting screen (Refer to pages 170 and 182.)
- Lamp colors when they are on, and lamp guide display character colors (Refer to page 157.)
- Touch switch colors when they are on, and guide display character colors (Refer to page 161.)
- Display color of eight dots beyond the top of a bar graph, and screen background color (Refer to page 145.)

### Transparent Display

When two display elements overlap with each other, the background color of the overlying element conceals the underlaid display element.

Besides the above eight colors, the color of “transparency” is available for the background of some display elements.

When “transparency” is set, nothing appears behind a display element, and the display element or screen background color under it becomes visible.

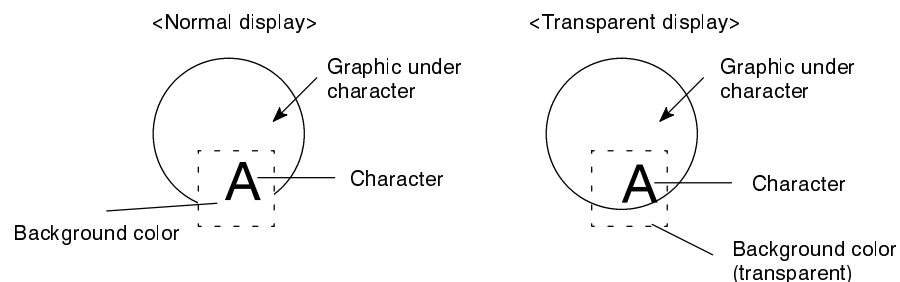

- Display elements which can be displayed in the color of “transparency”
  - Normal display characters
  - Lamp (or touch switch) guide display characters
  - Lamps (or touch switches) when they are off
  - Filled graphic patterns
- Display elements which cannot be displayed in the color of “transparency”
  - Display character-strings in character-string memory table
  - Display numeric values in numeral table
  - Numeric values and character-strings on numeral and character-string setting screen
  - Characters indicating percentage (%) on graphs

**Color Display of the Screen** The background color of the entire screen can be specified. Set the background color as a screen attribute when creating screen data on the support tool.

**Color Display of Characters** The color of characters (character color) and that of the square frame (background color) can be specified.

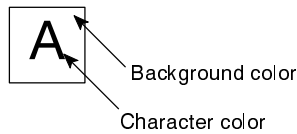

**Color Display of Graphics** The outline of a graphic can be drawn in a specified color, and the graphic can be filled in a pattern in specified colors.

As filling pattern colors, the display color of the pattern itself, the pattern background color and the filled area boundary line color can be set.

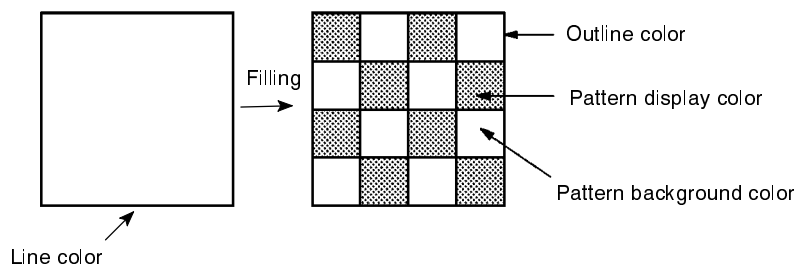

When a lamp, a touch switch and a graphic are to be displayed in specific colors, part of the frames of the display elements may be invisible because of the combination of the background, outline and filling colors. This is a phenomenon peculiar to a color LCD, not a failure with the system.

In such a case, change the color combination.

### 4-2-3 Characters and Figures which can be Displayed

The NT620S/620C screen can display characters, figures, and other various elements.

This section describes the types and attributes of the characters and figures which can be displayed and do not need to be changed at all.

For the settings, display, and use of the characters, numeric values, and graphs which change according to the system operation status and other conditions, refer to Section 4-4 "Memory Table" (page 139) and Section 5-2 "Memory Tables and Graph" (page 215).

The power of expression of the screen can be increased by giving various attributes such as the enlarged or reverse display to the characters and figures.

The character and figure attributes can be set in the edit screen when creating the screen data by using the support tool.

#### Types and Attributes of Characters

On the NT620S/620C, the following types of character can be entered and displayed.

Character Type	Dots (vertical x horizontal)	Character Set	Maximum Number of Characters Displayed in One Screen (without overwriting)	
			NT620S	NT620C
Half height character	8 x 8	Alphanumerics and symbols	80 characters x 50 lines (4000 characters)	80 characters x 60 lines (4800 characters)
Normal characters	8 x 16	Alphanumerics and symbols	80 characters x 25 lines (2000 characters)	80 characters x 30 lines (2400 characters)

The NT620S/620C is provided with "marks", "image data" and "library data" in addition to regular characters.

- Marks

A mark is a graphic pattern combining 16 x 16, 32 x 32 and 64 x 64 dots. But 32-dot and 64-dot marks are combinations of 4 (2 x 2) and 16 (4 x 4) 16-dot marks, respectively.

Up to 224 16-dot marks can be registered in one screen data file.

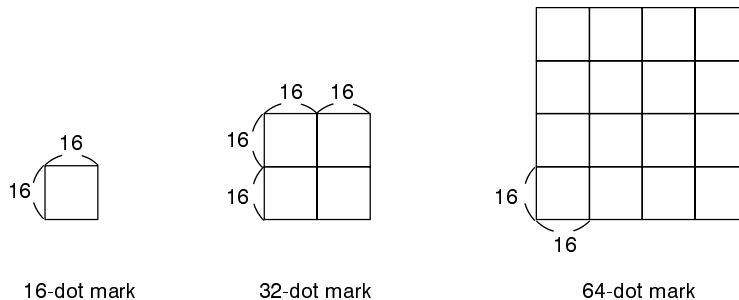

- Image data

Image data is a set of images of which sizes can be designated in units of 8 dots in a square area.

NT620S : Min. 8 × 8 dots to Max. 640 × 400 dots (entire screen)

NT620C : Min. 8 × 8 dots to Max. 640 × 480 dots (entire screen)

Create images to be registered as image data by cutting part of another display screen or drawing them on the screen when creating screen data. All data displayed on the entire screen can also be registered as image data.

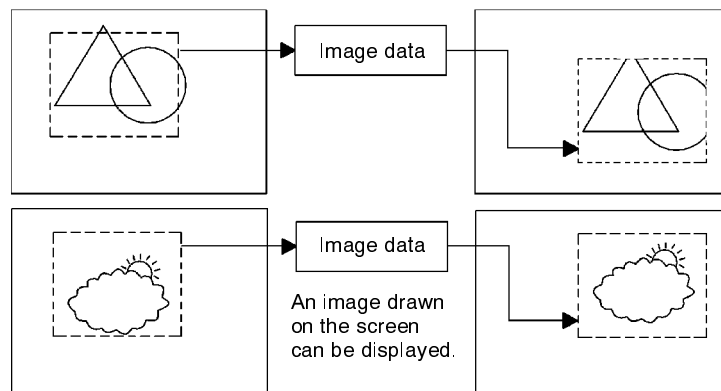

Image data of up to 224 images can be registered in a screen data file as code of FE20 to FEFF.

Basically, image data can be displayed in any position on the screen, however, the entire image may not be displayed in some specific positions.

- Library data (Ver.3 direct connection or later version)

Library data is image data consisting of plural characters and graphics.

The size can be specified within the following range of rectangular areas.

NT620S : Min. 1 × 1 dot to Max. 640 × 400 dots (entire screen)

NT620C : Min. 1 × 1 dot to Max. 640 × 480 dots (entire screen)

The creation of library data starts by laying out characters and graphics with attributes on the screen in the same manner as regular screen data.

Next, specify the area to be registered. Only characters and graphics can be extracted from other screen data and registered as library data.

Library data cannot be registered as display elements.

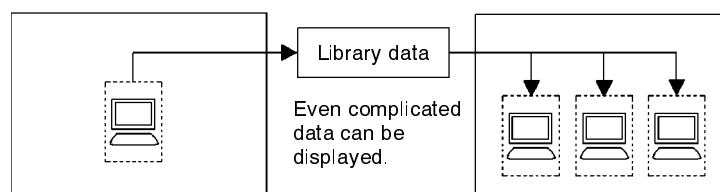

Once they are registered as library data, complicated images composed of characters and graphics can be displayed many times easily, and need not be created again. The image data memory can be saved at the same time.

Library data of up to 896 images can be registered in a screen data file as code of FA20 to FAFF, FB20 to FBFF, FC20 to FCFF and FD20 to FDFF.

Basically, library data can be displayed in any position on the screen. But, in a position where the entire library data cannot be displayed, it automatically moves to another position. Use care in setting a display position.

**Reference**

Difference between image data and library data

While image data can take any form as shown in the screen example, only images consisting of characters and graphics can be library data.

Because only drawn characters and graphic images are registered as library data, library data requires less memory capacity than image data of which the dots to be displayed on the screen are all registered.

- Enlargement of characters and marks

Characters and marks can be enlarged to the following scales. Image data and library data are exceptions.

Double-width scale, Double-height scale, x4 scales, x9 scales, x16 scales, x64 scales

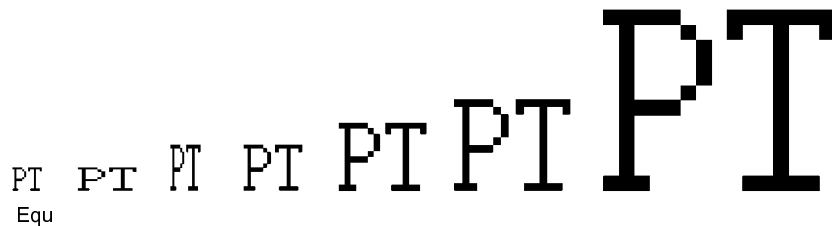

- Smoothing

Characters (or marks) enlarged to x4 scales or larger are displayed with the outline automatically smoothed. This function is called "smoothing". Image data and library data cannot be smoothed.

Enlarged Characters      Enlarged Characters

With smoothing

Without smoothing

- Color display (NT620C only)

Number of colors: 8

Number of background colors: 8 or "transparent"



- Reverse and flashing display

Normal display:

Characters and the background are displayed in a designated color.

Reverse display:

The display brightness of the character and the background is reversed comparing with the normal display.

Flashing display:

Characters are displayed as they flash. The normal display alternates with no-display.

Reverse and flashing display:

The reverse display alternates with the normal display.

Reverse display, flashing display, and reverse and flashing display are not possible for image data.

Library data will be inverted, flashed or inverted and flashed alternately according to the setting at registration.

**Graphic Types and Their Attributes**

On the NT620S/620C, the following types of graphic can be entered and displayed:

Polylines

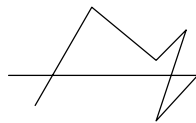

\* A polyline with up to 255 middle points can be drawn.

Square



Polygon



\* A polygon with up to 255 vertexes can be drawn.

Circle



Arc



Fan



- Designation of line types

Straight lines are available in the following four types:

Solid line      \_\_\_\_\_

Broken line    - - - - -

1-dot chain line    — — — — —

2-dot chain line    — — — — —

Other graphics can be drawn only with a polyline.

- Filling

The areas of graphics within the outline (closed areas) can be filled in a tiling pattern.

There are ten tiling patterns, as shown below:

Name	Pattern	Name	Pattern
Flat		Slant right	
Box		Crosshatch	
Slant left		Grid	
Stripe		Border	
Diamond		Halftone	

- Color display (NT620C only)

Number of graphic frame colors: 8

Number of display colors (in filling): 8

The tiling pattern colors are display colors.

Number of background colors (in filling): 8 or “transparent”

The color visible between the blocks of the tiling pattern is the background color. When “transparent” is selected, the display element under the graphic appears to be transparent.

Number of outline colors (in filling): 8

The color of the boundary line surrounding the area to be filled is the outline color.

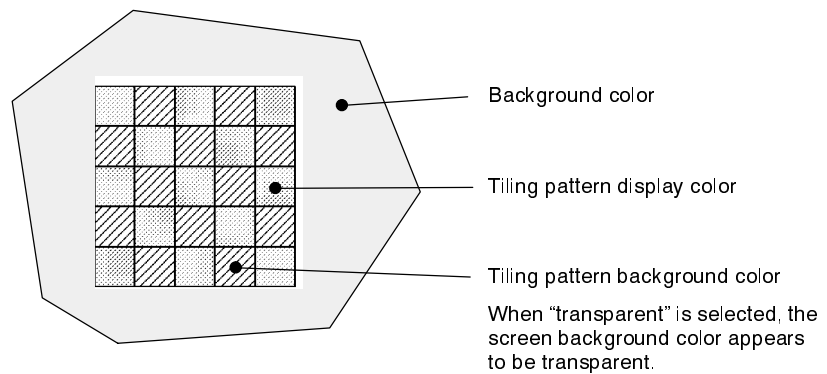

Part of the graphic frame may be invisible because of the combination of the display (in filling), background and outline colors. This phenomenon is peculiar to a color LCD, not a failure with the system.

In such a case, change the color combination.

- Reverse and flashing display

Normal display: Only the outline of a graphic is displayed in a designated color.

Reverse display: A graphic filled in the same color as that of the graphic outline is displayed.

Flashing display: Normal display alternates with no-display.

Reverse and flashing display: Normal display alternates with reverse display.

Polylines and arcs cannot be inverted, flashed or inverted and flashed alternately.

Filling can be designated only with normal display.

**Note**

Do not fill graphics to which a flashing display or inverse flashing display attribute has been set.

If a graphic with a flashing display or inverse flashing display attribute is to be filled, the area outside the graphic may be filled in the same pattern when the system operates.

## 4-2-4 Communication with the PC

### Communication Using Host Link/NT Link

The NT620S/NT620C can communicate with a PC by using the host link/NT link. Using the host link/NT link, bits and words can be allocated to any area in the PC memory and data can be written to and read from these bits and words directly. This makes the following functions possible:

Control and notification of screen elements

Control and notification of NT620S/NT620C statuses

Screen switching

Obtaining the screen number of the currently displayed screen

Memory table operations

For details on the actual operations required for these functions, refer to Section 5 "Using Host Link/NT Link".

### NT620S/NT620C Functions that can be Controlled

The following NT620S/NT620C functions can be controlled.

Screen display: Screens can be displayed and deleted.

Buzzer: Three types of buzzer can be sounded, and stopped.

Display history initialization:  
The display history can be initialized.

Window control: The opening of pop-up windows can be disabled.

Numeral/character-string input control:  
The input of numerals and character-strings can be disabled.

For details on the actual methods used for these types of control with the NT620S/NT620C, see Section 5-7 "NT620S/620C Status Control" (page 257).

**Ascertainable NT620S/NT620C Operation Statuses**

The following NT620S/NT620C statuses can be ascertained.

Operating status:	Whether the NT620S/NT620C is operating or not
Battery voltage:	The battery voltage
Screen number:	The screen number of the currently displayed screen
Numeral setting input:	Whether a numerical value has been input with a numeral setting
Printer operating status:	Whether the printer is printing or stopped

For the actual methods used to determine these operation statuses of the NT620S/NT620C, see Section 5-8 “Notification of the Operating Status to the PC (Determining the NT620S/620C Operating Status)” (page 263).

## 4-3 Screen Display

This section describes the screen information required for the operation with the NT620S/620C.

For the actual method used to change the displayed screen, see “Switching the Screen Display” (page 207).

For the actual method used determine the screen number of a displayed screen, see “Notifying the Display Screen to the PC (To display the Number of Currently Displayed Screen)” (page 212).

### 4-3-1 Classification of Screens

The NT620S/620C is provided with the following types of screens which are classified by the display method.

- Normal screen
- Overlapping screen
- Continuous screen

The screen type is set with each screen in the “Screen Selection” screen of the support tool. Select a screen type according to the purpose, and create characters and figures on the screen. The details of each screen type are given below.

#### Normal Screen

A normal screen is the basic screen of the NT620S/620C. It is not necessary to select a screen type (overlapping or continuous) when to create the screen data on a normal screen.

When a normal screen is selected, existing screens will be erased and a normal screen will be displayed.

#### Overlapping Screen

Several normal screens can be overlapped and displayed as one screen. A group of overlapped screens is called an “overlapping screen”.

Several normal screens are displayed in the order of screen numbers which have been designated to each screen and form an overlapping screen. Up to eight screens can be overlapped to form one overlapping screen. The base screen used for making an overlapping screen is called a “parent screen”, and a bunch of screens which are laid over the parent screen are called “child screens”.

All display elements can be used on a parent screen.

The screen attributes such as a buzzer attribute set in the parent screen become effective in an overlapping screen.

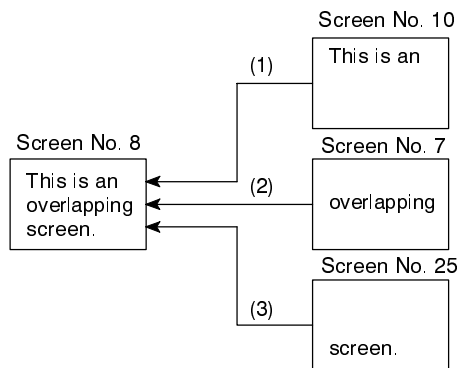
**[Example overlapping screen]**

- Parent screen: No. 8
- Child screens: No. 10, No. 7, and No. 25

When screen No. 8 is designated, screen No. 8 becomes the parent screen and the child screens No. 10, No. 7, and No. 25 are displayed over the parent screen in that order.

Only one numeral setting screen or character-string setting screen (screens which allow numeral and character-string input on the NT620S/NT620C screen) can be registered as a child screen. For details on numeral settings, see Section 4-8 “Numeral Setting” (page 170), and for details on character-string settings, see Section 4-9 “Character-String Setting” (page 182).

Make sure that the touch switches and numbers set in the normal screens do not overlap in an overlapping screen. If the set positions of the touch switches and/or numbers in the normal screens overlap with each other, such settings may sometimes not be effective as intended. Use the support tool and make sure that the set positions do not overlap with each other.

**Continuous Screens**

A group of normal screens which are related in series and can be switched consecutively is called the “continuous screens”. Up to eight screens can be registered to one screen as a group of continuous screens.

The base screen used for registering the continuous screens is called a “parent screen”, and the registered continuous screens are called “child screens”.

The current screen number and the total number of continuous screens can be displayed in the top right corner of the screen. This is called the “page number display”.

The page number is set when creating the screen data by using the support tool. Refer to the “NT-series Support Tool Operation Manual” (V028-E1-□).

All display elements except “numeral setting” and “character-string setting” can be used in the continuous screens.

The screen attributes set in the parent screen become effective in the continuous screens.

**[Example continuous screens]**

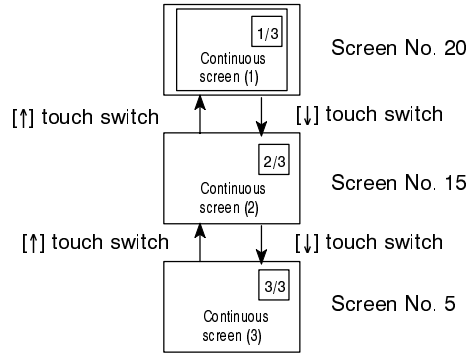

- Parent screen: No. 10
- Child screens: No. 20, No. 15, and No. 5

When screen No. 10 (continuous screen) is designated, screen No. 20 which is page 1 of the continuous screens will be displayed. Screen No. 15 or No. 5 can be displayed by using the touch switches. Since screen No. 10 has been set for the continuous screens, that screen cannot be displayed as an individual screen.

**Switching the Continuous Screens by Using the Touch Switches**

Continuous screens can be switched by using touch switches to which control keys  $\uparrow$  and  $\downarrow$  have been allocated.

If the numeral setting attribute of the parent screen is “system”, the  $\uparrow$  and  $\downarrow$  control keys will be automatically created as shown in the figures below.

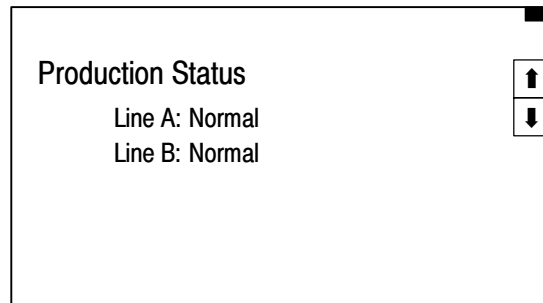

If the numeral setting attribute of the parent screen is “user”, create touch switches to which the control keys  $\uparrow$  and  $\downarrow$  are allocated during screen creation (see “Control Key Function”, page 167).

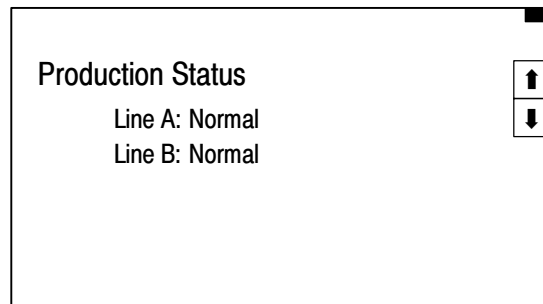

## 4-3-2 Screen Attributes

Each screen can be set with a specific function by designating a screen attribute, so that the specific function can be executed by displaying the screen. For example, by displaying a screen to which a “buzzer attribute” has been set, the buzzer of the NT620S/620C starts sounding.

Screens attributes are set for each screen on the “Screen List” screen. Note that the support tool displays the “Alarm” attribute but this attribute cannot be used with the NT620S/NT620C.

The following several attributes can be set with one screen.

- Buzzer attribute

This attribute will become effective to sound the buzzer in the NT620S/620C when the screen to which this attribute has been set is displayed. The buzzer sound can be set as follows:

No: Buzzer does not sound when the screen is displayed.

Continuous sound: Buzzer sounds continuously.

Short: Buzzer sounds intermittently at 0.5 second intervals.

Long: Buzzer sounds intermittently at 1.0 second intervals.

The buzzer sound is set with the NT620S/620C memory switch. The buzzer can also be set by using the PC. Refer to “Using the buzzer” (page 87) for the buzzer setting using the memory switch.

To stop the buzzer by using the screen operation, create a  control key as a touch switch.

- History attribute

When a screen for which this attribute is set is displayed, the screen number of the displayed screen, the day minute and second of display, the number of display events, and a message, is recorded as display history record data.

The display history record data can be read either in the maintenance mode or by using the support tool. It is also possible to display this data by calling screen numbers 1997 and 1998 (see page 125).

- Numeral setting attribute

Select whether the numeric keys or control keys are automatically displayed or the numeric keys are created at arbitrary positions on the numeral setting screen. The following two numeral setting attributes are used.

System: The numeric keys or control keys registered to the system are automatically displayed.

User: The numeric keys or control keys can be created at any arbitrary positions.

- Back col (NT620C only)

Screens for which this attribute has been set are automatically displayed with the set background color extending over the entire screen.



## 4-4 Memory Tables

The NT620S/620C has the “character-string memory table” for the character data, the “numeral memory table” for numeric data and the “bit memory table” for bit data, which can be written and updated by the PC.

The contents of the memory tables can be set by using the support tool when displaying the memory tables on the screen or by editing the table.

### 4-4-1 Character-String Memory Table

The character-string memory table is an NT620S/620C internal memory used to store the character data. Up to 1000 character-string memory tables can be used, and up to 20 full size characters (40 bytes) can be stored in one memory table. The character-string memory tables at up to 50 positions can be registered in one screen.

#### Number of Character-string Memory Tables

Set the number of character-string memory tables in the support tool’s “system memory”.

256 : Sets the number of character-string memory tables to 256

1000 : Sets the number of character-string memory tables to 1000.

The difference between setting 1000 character-string memory tables and 256 character-string memory tables in terms of the memory capacity required for screens is 29760 bytes.

#### Displaying a Character-string

The character-string memory tables are registered with table numbers 0 to 999.

When creating the screen data by using the support tool, set the position on the screen to display a character-string and also set a character-string number to be displayed.

When the NT620S/620C is operated, the screen displays the contents of the character-string memory table.

For the actual method used to modify a currently displayed character-string, see “Changing Displayed Numerals or Character-Strings (Changing the Contents of Allocated Words)” (page 223).

Character-string memory tables are divided into two types depending on their numbers. Numbers 0 to 255 can be written to and read from without restriction, while numbers 256 to 999 are read-only character-string memory tables.

The difference in the way memory tables are used depending on which of these number groups they fall into is explained below.

- Memory Table from 0 to 255

During PT operation, the character-string data in the Character-String Memory Table written from the PC is displayed in the screen. An initial value can also be set when screen data is created.

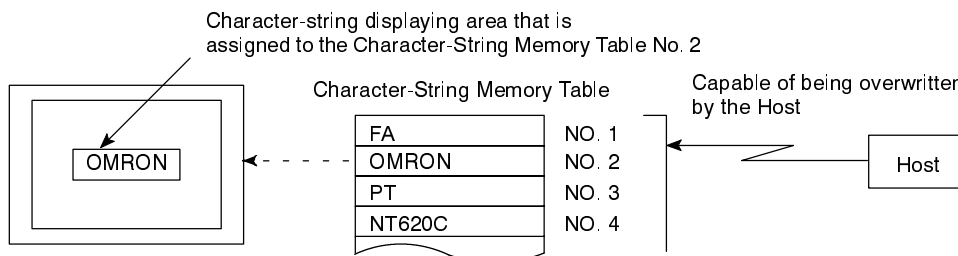

- Memory Table from 256 to 999 (read-only)

Data cannot be written by the PC. Character-string data is set when screen data is created. This Memory Table can be set not to be used by the “System Memory” setting of the support tool.

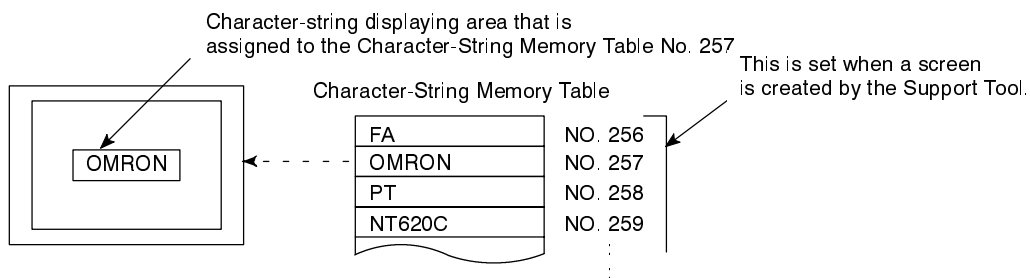

### Characters and Figures which can be Displayed

The power of expression of the screen can be increased by giving various attributes such as the enlarged or reverse display to the characters of the character-string memory table.

The character attributes can be set in the edit screen when creating the screen data by using the support tool.

The following types of characters can be displayed on the NT620S/620C:

Character Type	Dots (vertical x horizontal)	Character Set	Maximum Number of Characters Displayed in One Screen (without overwriting)	
			NT620S	NT620C
Half height character	8 x 8	Alphanumerics and symbols	80 characters x 50 lines (4000 characters)	80 characters x 60 lines (4800 characters)
Normal characters	8 x 16	Alphanumerics and symbols	80 characters x 25 lines (2000 characters)	80 characters x 30 lines (2400 characters)
Marks	16 x 16, 32 x 32, 64 x 64	Create by using the support tool		
Image data	Not fixed (8-dot units in both horizontal and vertical directions)	Created using the support tool		
Library data	Not fixed	Created using the support tool		

- Enlarged display of the characters and marks

The characters and marks can be enlarged to the following scales.

Double width scale, Double height scale, x4 scale, x9 scale, x16 scale, x64 scale

- Smoothing

The characters and marks enlarged to the x4 scale or larger are displayed with the outline automatically smoothed. This function is called "smoothing".

- Reverse and flashing display

Reverse display:

The display brightness of the character and the background is reversed comparing with the normal display.

Flashing display:

Characters are displayed as they flash. The normal display alternates with no-display.

Reverse and flashing display:

The reverse display alternates with the normal display.

- Character color (NT620C only)

When using an NT620C, colors can be assigned to characters as follows:

Character display color: 8 colors

Character background color: 8 colors

## 4-4-2 Numeral Memory Table

The numeral memory table is an NT620S/620C internal memory used to store the numeral data. Up to 1000 numeral memory tables can be used, and up to 8 digits (4 bytes) of numeral data (including signs) can be stored in one numeral memory table. The numeral memory tables at up to 50 positions can be registered in one screen.

### Number of Numeral Memory Tables

Set the number of numeral memory tables in the support tool's "system memory".

512: Sets the number of numeral memory tables to 512

1000: Sets the number of numeral memory tables to 1000.

The difference between setting 1000 numeral memory tables and 512 numeral memory tables in terms of the memory capacity required for screens is 4880 bytes.

### Displaying a Numeral

The numeral memory tables are registered with table numbers 0 to 999.

When creating the screen data by using the support tool, set the position on the screen to display a numeral and also set a numeral number to be displayed.

When the NT620S/620C is operated, the screen displays the contents of the numeral memory table. For the actual method used to modify a currently displayed numerical value, see "Changing Displayed Numerals or Character-Strings (Changing the Contents of Allocated Words)" (page 221).

Numeral memory table numbers 247 through 255 are used for the clock function. They cannot be used for other applications. For details on the clock function, see Section 5-6 "Clock Function" (page 251).

### Numerals which can be Displayed

The power of expression of the screen can be increased by giving various attributes such as the enlarged or reverse display to the numerals of the numeral memory table.

The numeral attributes can be set in the edit screen when creating the screen data by using the support tool.

The following types of numerals can be displayed on the NT620S/620C:

- Digits of the whole numbers: 1 to 8 digits
- Digits of the decimal fraction: 0 to 7 digits
- Character sizes: Half, normal
- Enlarged display: Double width, double height, x4, x9, x16, x64

The characters enlarged to the x4 scale or larger are displayed with the outline automatically smoothed. This function is called "smoothing".

- Character background color: 8 colors
- Sign display setting
- Decimal/hexadecimal display setting
- Zero suppress setting

The character display color and character background color can only be specified when using an NT620C. When displaying the same numeral memory table simultaneously on more than one screen, make sure the display attributes are the same on all screens. If the display attributes are changed, correct display may not be possible.

**Reference**

Zero suppress setting

The numeral data are displayed in designated display areas as right-aligned. If the number of digits of a numeral data is smaller than that of the display area, number "0"s will be displayed at the vacant digits. These "0"s will not be displayed if the zero suppress setting is made for "Yes".

**4-4-3 Bit Memory Table**

The Bit Memory Table is an internal memory for contact data.

The NT620S/620C can use a maximum of 256 Bit Memory Tables. One contact status on the PC can be stored in a single Bit Memory Table.

**Functions of Bit Memory Table**

There are two functions of Bit Memory Table:

- Screen changeover function

When any contact on the PC to which the Bit Memory Table is assigned is changed from "0" (OFF) to "1" (ON), the screen is changed over to show a screen being set to that contact.

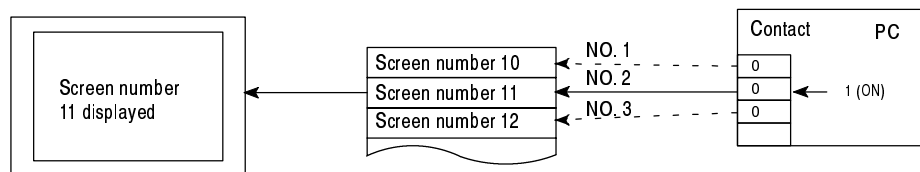

- Alarm list function

When any contact on the PC assigned to the Bit Memory Table is "1" (ON), the Character-String Memory Table (message) and Image Library being set are displayed. Since smaller Bit Memory Table number is displayed preferentially when multiple Bit Memory Tables have been set to the alarm list function, the order of priority can be given to the message to be displayed. For details, refer to the "4-11 Alarm List & History Display Functions" (page 192).

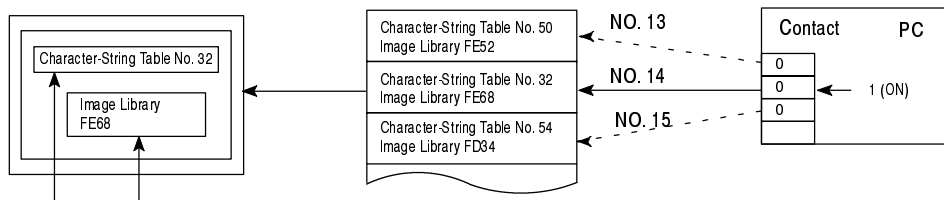

Message (character-string No. 32) and Image Library (FE68) set to the Bit Memory Table number 14

### Bit Memory Table Setting

When the Bit Memory Table is used, it is necessary to perform the following setting at each Table before creating the screen data with the Support Tool. For the setting used for alarm list and history display function, refer to the 4-11 “Alarm List & History Display Functions” (page 192).

- Recording in the alarm history

This setting is to determine whether a change of PC contact to which the Bit Memory Table is assigned is recorded in the Alarm History.

- Screen changeover function

This setting is to determine whether the Bit Memory Table is used for the screen changeover function.

- Character-string memory table number

The Character-String Memory Table number displayed as a message is set. This setting is not necessary when used for the screen changeover function.

- Display color (NT620C only)

Color of the characters used for message is to be set. This setting is not necessary when used for the screen changeover function.

- Image library

This is a setting of a code for Image Library data displayed together with a message. This setting is not necessary when used for the screen changeover function.

- Screen changeover

This is a setting of a screen number displayed for the screen changeover function or alarm list & history display function.

- Contact

This is a setting of a contact on the PC to which the Bit Memory Table is assigned.

Symbol	C Series PCs	Allocated	CVM1/CV Series PCs	Allocated
DM	Data Memory	✓	Data Memory	✓
CH	Internal/Special Relay	✓	Internal/Special Relay	✓
TIM	Timer	×	Timer	×
CNT	Counter	×	Counter	×
HR	Holding Relay	✓	–	
AR	Auxiliary Relay	✓	Auxiliary Relay	×
LR	Link Relay	✓	–	

✓: OK    ×: NG

The Auxiliary Relay area of CVM1/CV series PC is used exclusively for special application in the system, and cannot be used for other application.

When the Data Memory (DM) is specified, a bit number (00 to 15) is also specified in conjunction with a channel number.

## 4-5 Graphs

The contents of the numeral memory tables of the NT620S/620C can be displayed as graphs as well as numeral data.

Three types of graph can be displayed: bar graphs, trend graphs, and broken line graphs.

The display data of graphs is changed by changing the contents of numeral memory tables.

For the actual method used to update the data of a currently displayed graph, see “Upgrading Graphs (Changing the Contents of Allocated Words)” (page 230).

Graph settings are made when creating screen data using the support tool.

### 4-5-1 Bar Graph Functions

The bar graph function displays a value in a bar graph form as a percentage to the specified value according to the contents of a numeral memory table. Up to 50 bar graphs can be registered in one screen.

- Reference table

The numeral memory table used as the reference for the bar graph display can be set.

The support tool has the “direct” and “indirect” options for the reference method of the numeral memory table. However, the NT620S/620C recognizes the “direct” method only.

The bar graph display cannot use hexadecimal numbers. If hexadecimal numbers are set in the reference numeral table, the bar graph cannot be displayed. Use caution not to write hexadecimal numbers except the minus sign “F” to the reference numeral table.

#### Bar Graph Attributes

The following attributes can be set with the NT620S/620C for the bar graph display:

Use the support tool to make settings for the bar graph display when creating the screen data.

- Graph frame

This attribute specifies a rectangular area used to display a graph.

- Orientation and incremental direction

The orientation and incremental direction of the bar graph can be selected from those mentioned below.

↑ (up): The bar graph increments upward in the vertical orientation.

↓ (down): The bar graph increments downward in the vertical orientation.

← (left): The bar graph increments to the left in the horizontal orientation.

→ (right): The bar graph increments to the right in the horizontal orientation.

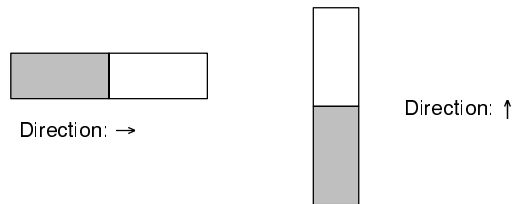

- With/without a graph frame

Select whether or not the graph frame (boundary line of a graph display area) which indicates the effective display range is displayed.

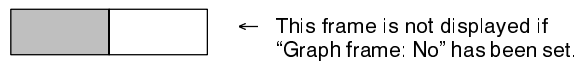

- % Data value

Data value corresponding to 0%, 100%, –100% can be specified. % Data value can be specified by two methods: by directly specifying a numeric value and/or by referring to the Numeral Memory Table.

- Directly specifying method

Numeric value from 0 to 99999999 (max. 8-digit) is specified. It is necessary to set that 0% value is more than –100% one, and 100% value be more than 0% one without fail.

- Memory table referring method

Numeral Memory Table number to be referred is specified instead of a numeric value. With this method specified, each data value can be changed from the Host during operation.

- % Display

% Value can be displayed.

% Value can be calculated according to the following equation:

$$\% \text{ Value} = \frac{\text{Referred Numeral Memory Table value} - 0\% \text{ Value}}{100\% \text{ Value} - 0\% \text{ Value (or } 0\% \text{ Value} - (-100\% \text{ Value))}} \times 100$$

Attribute of numeric value displayed is the same as that for character display. Refer to the “Numerals which can be Displayed” (page 142).

- Sign display and display method

Select whether or not the bar graph which indicates a value below 0% is displayed.



[To display a value below 0%: Sign display “Yes”]

The bar graph is displayed in the range of -100% to 100%. The middle of the bar graph indicates 0%.

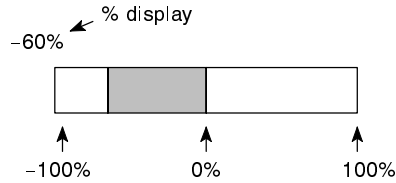

[Not to display a value below 0%: Sign display “No”]

The bar graph is displayed in the range of 0% to 100%. The end of the bar graph indicates 0%. Values below 0% are indicated as 0%.

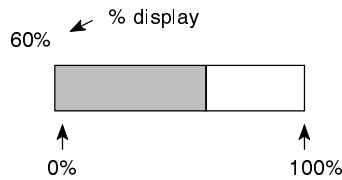

- Differences in the bar graph display method according to the % values

The bar graph display method varies according to the % value range.

- (1) When the % value is in the minus range

The display varies as follows according to the sign display setting:

Sign display “No”: Displayed as 0%.

Sign display “Yes”: Displayed in the minus range.

- (2) When the absolute value of the % value is in the range of 100% to 999%

The % value is displayed as it is.

Sign display “No”: The display will be as mentioned below according to the graph frame setting.

When the frame is displayed:

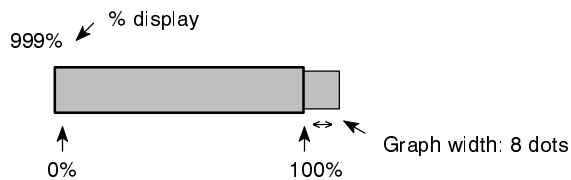

When the frame is not displayed:

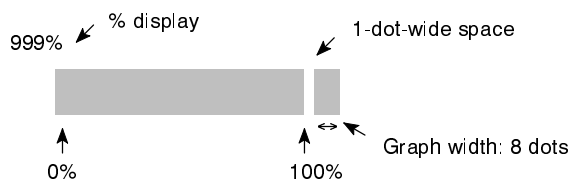

Sign display “Yes”: A value below -100% will be displayed in the minus direction as shown above.

(3) When the absolute value of the % value is above 1000%

The bar graph will be displayed the same as (2) above.

The % value is displayed as follows according to the sign display setting:

Sign display “No”: \*\*\*%

Sign display “Yes”: \*\*\*\*%

- Color display (NT620C only)

Color of a graph to be displayed can be specified. For background of a graph, screen background color is displayed.

Graph frame (in case of a graph frame): 8 colors

+ direction display area: 8 colors

- direction display area: 8 colors

## 4-5-2 Trend Graph Setting

A trend graph displays the displacement with the lapse of time as a locus while monitoring (sampling) the Numeral Memory Table value periodically. As time goes by, the displacement varies as shown below.

<Example of normal type that increases rightward with a sign displayed>

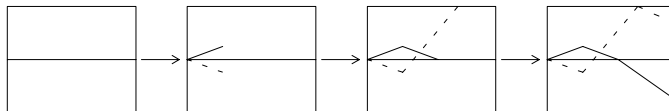

For a trend graph, a single graph frame can be shown in a screen and a maximum of 50 graphs can be registered in the graph frame.

- Reference table

This is the same as for bar graphs. See page 145.

Although it is possible to select either “direct” or “indirect” as the reference method with the support tool, only the “direct” setting is meaningful when using an NT620S/NT620C.

It is not possible to use hexadecimal values for trend graphs. If hexadecimal values are specified in numeral memory tables referenced to obtain graph values, the graph will not be displayed. The letter “F” may be used to indicate negative values, but make sure that no hexadecimal values are written.

### Trend Graph Attributes

When using an NT620S/NT620C, the following attributes can be used when displaying trend graphs.

- Graph frame

This attribute specifies a rectangular area used to display a graph.

This area can occupy the following range:

- NT620S: Max. 640 dots horizontally x 400 dots vertically
- NT620C: Max. 640 dots horizontally x 480 dots vertically

The following setting can be performed for a graph frame.

- Frame display

With the "Frame Display" specified, 1-dot width frame line is displayed outside of the frame area. When using an NT620C, color of a frame line can be selected out of eight colors.

- Background color in a frame: 8 colors (NT620C only)

Separate background color can be specified for positive and negative value display area.

• Displaying method

A graph displaying method can be selected out of two types: normal type and pen recorder type.

- Normal type

As time goes by, the latest data display position moves toward the direction of increase. When the displacement increases to the right, a graph varies as shown below. When a polygonal line reaches the end of a screen, it is cleared once and the NT610C starts drawing a polygonal line again from the first.

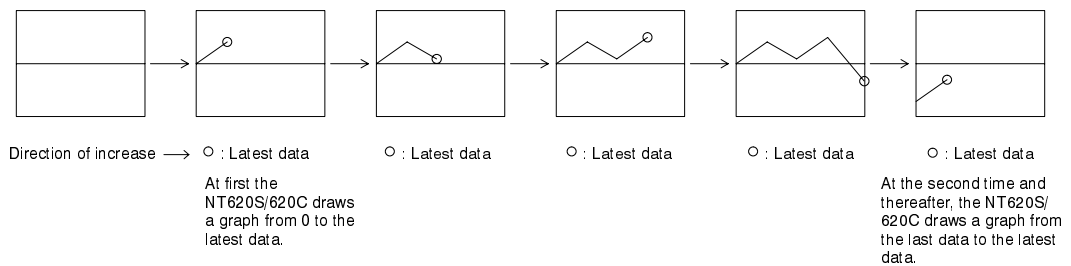

- Pen recorder type

The latest data is always displayed at the end of the screen. As time goes by, the graph already displayed moves in the direction of increase. When a graph increases to the right, it varies as shown in the figure below.

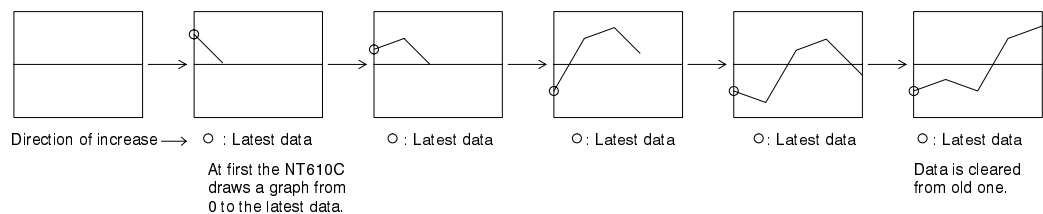

- Direction of movement

The normal type can select the direction that the display position of the latest data moves with the lapse of time. The pen recorder type can select the direction that entire graph moves.

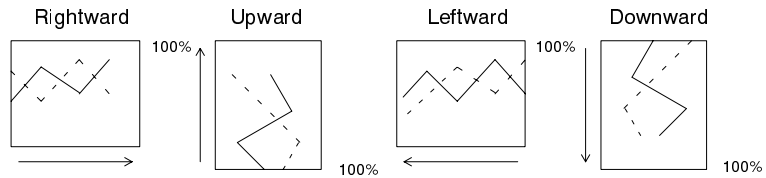

100% position is determined in accordance with the direction of scroll. 100% position falls to the right when a graph scrolls longitudinally and at the upper side when a graph scrolls laterally.

- Sign representation

This attribute can specify whether or not a numeric value less than 0% value is displayed.

[To display a value below 0%: Sign display “Yes”]

The trend graph is displayed in the range of -100% to 100%. In this case, 0% position of a graph falls the center of a graph display area.

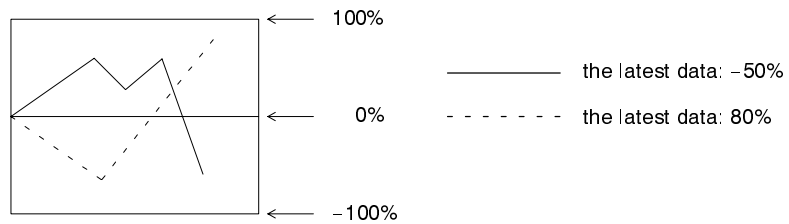

[Not to display a value below 0%: Sign display “No”]

The trend graph is displayed in the range of 0% to 100%. 0% position is at the end of a graph. All values less than 0% are displayed as 0%.

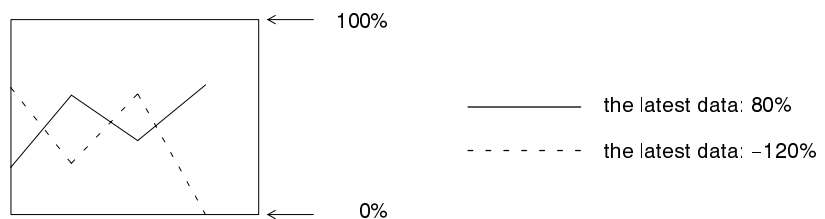

• Drawing width

Drawing width (direction of increase) must be specified from the previous data to the following data in the range of 1 to 640 dots. If a value more than the graph displaying frame is specified, a graph will not be displayed.

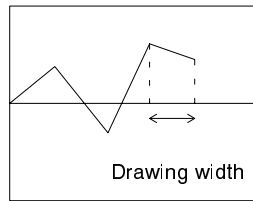

Direction of increase →

• Sampling period

Sampling period is the time interval applied when the NT610C samples and displays the Numeral Memory Table value and is specified in the range of 1 to 65535 in increments of 0.1 second.

**Reference**

Actual drawing timing varies depending on the operating conditions. This does not accurately coincide with the time interval specified.

• % Data value

The same is also true as the bar graph. Refer to page 146.

• Graph line type

This attribute specifies a graph line type among those as shown below. A graph width is fixed at one dot. Line color can be selected out of eight colors.

- Solid line      \_\_\_\_\_
- Broken line    - - - - -
- 1-dot chain line    — - — - —
- 2-dot chain line    — - - —

• % representation

The same is also true as the bar graph. Refer to page 146.

• Differences when a trend graph is displayed using percentage values

When % value is in the following range, the graph displaying method is restricted as follows:

(1) In case of negative % value

A graph is displayed differently depending on the sign representation.

Without sign representation: Displayed in the same manner as 0%.

With sign representation: A graph is displayed in the negative direction.

(2) When an absolute value of % is from 100% to 999%

A graph is not displayed in this range of %. Only a part of % value within the graph frame is displayed. A % value is displayed as it is.

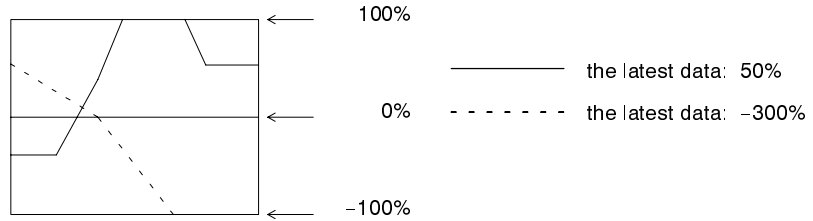

(3) When an absolute value of % is equal to or greater than 1000%

A value is displayed in a graph in the same way as (2) at the % display position depending on the presence of a sign as follows:

- Sign display "No": \*\*\*%
- Sign display "Yes": \*\*\*\*%

• When the graph width is not an integral multiple of the drawing width

In the normal type, when a graph is over the graph frame next time, the NT610C draws a graph of the latest data at the end of the frame.

< Example: In case the graph width 100-dot and the drawing width 30-dot >

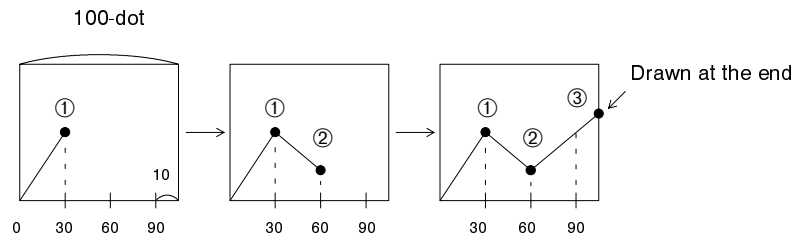

**Reference**

If a graph is duplicated by drawing multiple graph lines of the same % value, it is overwritten and displayed in the order of setting. Similarly, when 0% value continues in a graph with a sign displayed, a graph line is overwritten and displayed with respect to the graph frame indicating 0%.

### 4-5-3 Broken Line Graph Setting

A broken line graph displays multiple present value of Numeral Memory Table by a single polygonal line. This allows variation of continuous values of the Numeral Memory Table to be seen at a time.

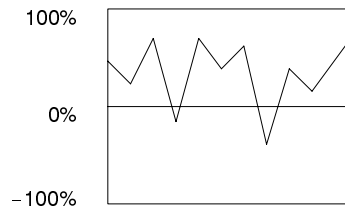

Example displaying 11 Numeral Memory Table values with signs

For a broken line graph, a single graph frame can be shown in a screen and a maximum of 256 graphs can be registered in the graph frame. A single broken line can display a maximum of 512 Numeral Memory Tables. However, the maximum number of numeral memory tables that can be displayed on one screen is also 512.

- Reference table

Specifies the first memory table number of the series of referenced memory tables.

Although it is possible to select either “direct” or “indirect” as the reference method with the support tool, only the “direct” setting is meaningful when using an NT620S/NT620C.

It is not possible to use hexadecimal values for broken line graphs. If hexadecimal values are specified in numeral memory tables referenced to obtain graph values, the graph will not be displayed. The letter “F” may be used to indicate negative values, but make sure that no hexadecimal values are written.

#### Broken Line Graph Attributes

When using an NT620S/NT620C, the following attributes can be used when displaying broken line graphs.

- Graph frame

This attribute specifies a rectangular area used to display a graph. This area can occupy the following range:

- NT620S: Max. 640 dots horizontally x 400 dots vertically
- NT620C: Max. 640 dots horizontally x 480 dots vertically

The following setting can be performed for a graph frame.

- Frame display

With the “Frame Display” specified, 1-dot width frame line is displayed outside of the frame area. Color of a frame line can be selected out of eight colors.

- Background color in a frame (NT620C only): 8 colors

Separate background color can be specified for positive and negative value display area.

- Direction

This attribute can select the direction of putting the referring Memory Table values in order.

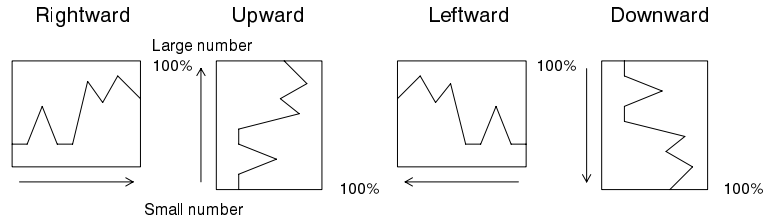

100% position is determined in accordance with the direction of putting the referring Numeral Memory Table values in order. 100% position falls to the right when putting those values longitudinally in order and at the upper side when putting those laterally.

- Sign representation

This attribute can specify whether or not a numeric value less than 0% value is displayed.

[To display a value below 0%: Sign display “Yes”]

The broke line graph is displayed in the range of -100% to 100%. In this case, 0% position of a graph falls the center of a graph display area.

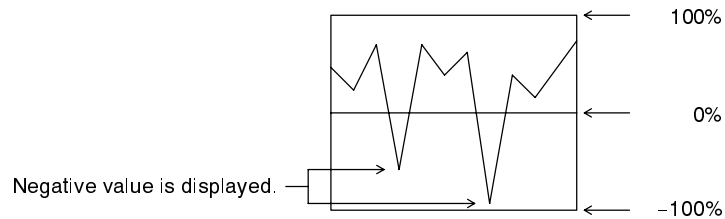

[Not to display a value below 0%: Sign display “No”]

The broken line graph is displayed in the range of 0% to 100%. 0% position is at the end of a graph. All values less than 0% are displayed as 0%.

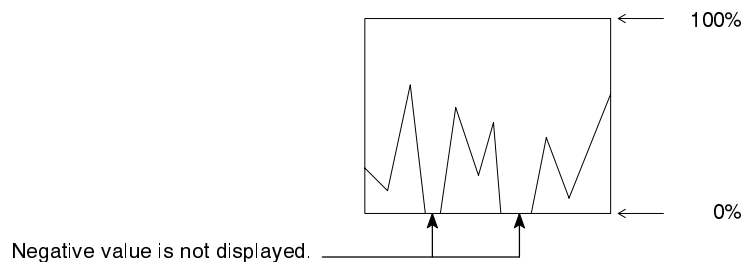



- Number of apexes

This specifies the number of Numeral Memory Tables to be referred to. One apex indicates a single Memory Table value.

Since a minimum of one dot width is required to display one Memory Table value as a polygonal line, maximum number of Memory Table capable of referring in accordance with a graph frame width is determined by the following equation.

$$\text{Graph frame width (number of dots)} \geq \text{Number of referring Memory Table}$$

- % Data value

This attribute specifies the % data value at every polygonal line. For the specifying method, the same is also true as the bar graph. Refer to page 146.

“% representation” cannot be performed for the polygon.

- Graph line type

This attribute specifies a graph line type among those as shown below. A graph width is fixed at one dot. Line color can be selected out of eight colors.

Solid line      \_\_\_\_\_

Broken line    - - - - -

1-dot chain line    — — — — —

2-dot chain line    — — — — —

- Differences when a broken line graph is displayed using percentage values

When % value is in the following range, the graph displaying method is restricted as follows:

(1) In case of negative % value

A graph is displayed differently depending on the sign representation.

Without sign representation: Displayed in the same manner as 0%.

With sign representation: A graph is displayed in the negative direction.

(2) When an absolute value of % is from 100% to 999%

A graph is not displayed in this range of %. Only a part of % value within the graph frame is displayed.

The values outside of this range are not displayed.

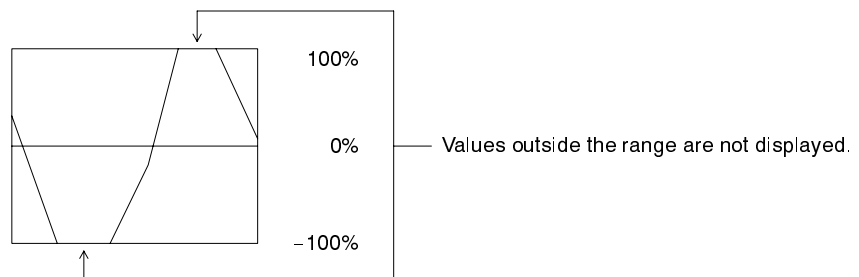

(3) When an absolute value of % is equal to or greater than 1000%

A value is not displayed in a graph in the same way as (2).

---

**Reference**

- If a graph is duplicated by drawing multiple graph lines of the same % value, it is overwritten and displayed in the order of setting. At this time, since the part that the lines are duplicated is displayed by use of those colors of the Exclusive OR display (Refer to page 126), the line type and line color are displayed differently than that specified.
  - Since a graph line is overwritten with respect to the graph frame when 0% value continues in a graph with a sign displayed, line type and line color are displayed differently than that specified.
  - When creating a graph, apexes of polygon are placed in order at regular intervals within the frame width. Apex interval can be changed freely when correcting a polygonal line.
-

## 4-6 LAMP

Lamp is a graphic area capable of changing the displaying state according to an instruction from the PC. There are two kinds of LAMPs: Normal LAMP that changes the displaying state (OFF, ON, Flashing) of a graphic fixedly displayed and Image Library LAMP that displays separate graphics in OFF and ON states. LAMP is set when creating a screen data with the Support Tool.

A maximum of 256 LAMPs can be set in a screen, and 1024 LAMPs can be registered in a screen data file.

Contents of the setting differs depending on the LAMP type (Normal LAMP, Image Library LAMP).

For the actual method used to modify a currently displayed lamp, see “Turning ON (lit) and OFF (unlit) the lamps (Changing the Contents of Allocated Bits)” (page 232).

### 4-6-1 Normal LAMP Functions

Normal LAMP is used to change the display state (reverse, reverse flashing, erase) of a graphic fixedly displayed according to an instruction (ON/OFF) from the PC.

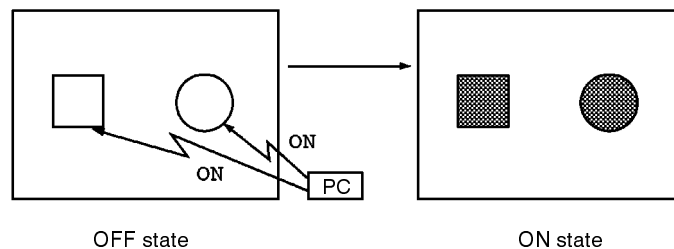

#### Normal LAMP Attributes

The following attributes can be set for the Normal LAMPs.

- Shape

Any shape can be selected out of the following four kinds of shapes. Size can be specified freely.



Square



Circle



Polygon



Fan

- Frame

Select whether or not the boundary line (frame) of the lamp display area is displayed. If the frame is not set, only the guide display message for the lamp is displayed when the lamp is not lit (or flashing). If the guide display message is not set, nothing is displayed.

- Lit and flashing

Select whether the lamp is lit (reverse display) or flashing (reverse flashing) when the lamp is turned ON by the PC.

- Color display (NT620C only)

External frame color (in case of color display): 8 colors

OFF color: 8 colors or “transparent”

Lit/Flashing color: 8 colors

A part of external frame may be lost depending on a combination of external frame color of the normal LAMP and OFF color or ON/Flashing color. This is caused by the properties of the color LCD and does not indicate failure of equipment. When part of the external frame is lost, change a combination of colors.

- Guide display message

Lamps can be displayed with the guide display messages.

The guide display message attributes are the same as that for the “character display”. Refer to “Characters and Figures which can be Displayed” (page 140).

- When a memory table display is overlapped with a normal lamp

The guide display character of the normal LAMP is a fixed character-string. In order to change the guide display of the normal LAMP according to the circumstances, display the display area of the Numeral Memory Table or Character-String Memory Table in conjunction with illumination of LAMP. However, depending on a timing of ON of normal LAMP and Memory Table update, the result of indication differs as shown in the examples below. Be careful when creating a control program.

Example 1: When the normal LAMP is turned on after updating the Memory Table

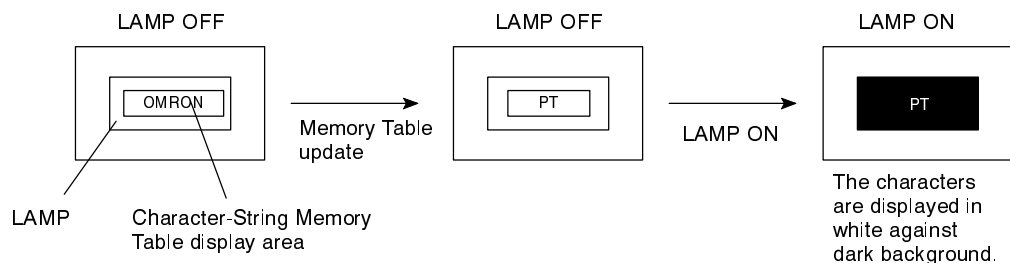

Example 2: When the Memory Table is updated while normal LAMP is ON

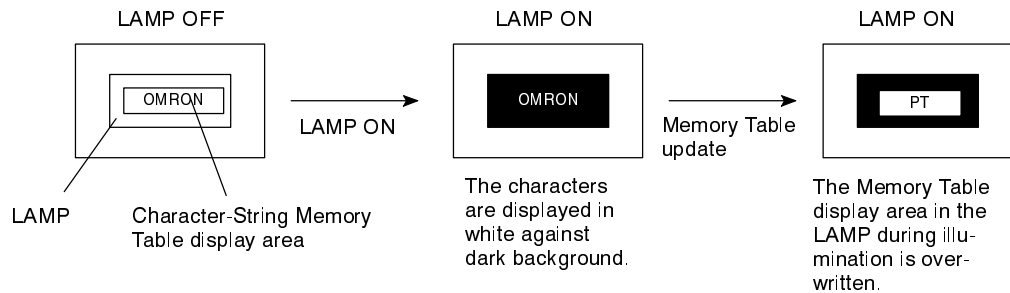

• Frame display and ON/Flashing

Lit/Flashing operations differ depending on the presence of the frame display of the normal LAMP.

When the frame is displayed, only an area within the frame is ON or flashing. When the frame is not displayed, an area is ON or flashing together with the frame.

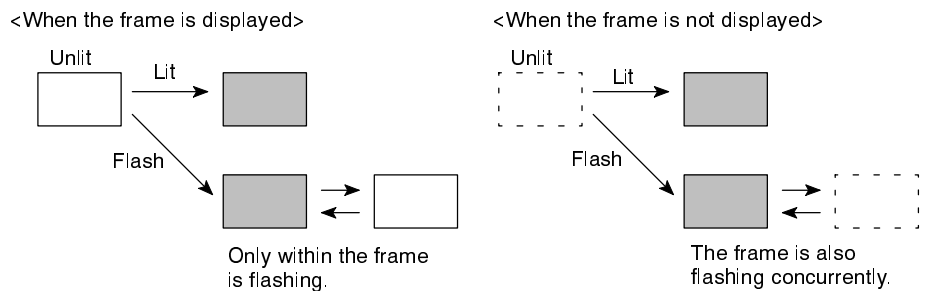

• Combined display of normal LAMP

With multiple LAMPs of the same number (or the same contact) registered, the LAMPs combined as shown below can be ON simultaneously.

<Display example>

The same number (or contact) is specified for the LAMPs L1 through L5.

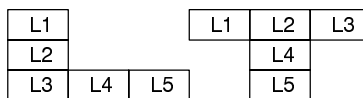

## 4-6-2 Image Library LAMP Setting

The Image Library LAMP overwrites a different graphic and displays it at a separate position according to an instruction (ON/OFF) from the PC.

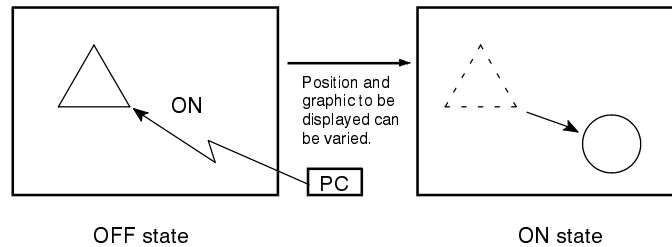

For the Image Library LAMP, presence of external frame, Lit/Flashing, color display, guide display, and so forth cannot be specified, unlike normal LAMP.

However, since the attributes of every display factors when registering the Library Data are displayed as they are, a range of application will be widened further.

### Image Library LAMP Attributes

The following attributes can be set to the Image Library LAMP.

- LAMP code

Graphics to be displayed during ON and OFF are specified by the Library Data or Image Data code, respectively.

- Display position

Positions to be displayed during ON and OFF are specified.

## 4-7 Touch Switches

The NT620S/620C has a function whereby input operations can be performed by using touch panels displayed on the screen. NT620S/620C screens can be switched, or bit information sent to the PC, by pressing (lightly touching) the “touch switches” in a panel.

The touch switches can also be made to light up (or flash) and go off like lamps.

Touch switches are set when creating the screen data with the support tool.

The following explanation covers the types of touch switch that can be displayed, and functions other than that for notification to the PC.

For the actual method used to notify touch switch statuses to a PC, see “Lit (Flashing) and Unlit Touch Switch Statuses (Changing the Contents of Allocated Bits)” (page 236).

For the actual method used to ascertain touch switch statuses at the PC, see “Notifying the PC that a Switch has been Pressed (Determining Touch Switch Status)” (page 237).

### Caution

- Do not use the PT touch switch input functions for applications where danger to human life or serious property damage is possible, or for emergency switch applications.
- Press touch switches with a force of no greater than 20 N. Applying higher force may cause glass to break, cause injuries, and prevent operation.
- Do not press touch switches carelessly while the backlight is off or while nothing is displayed on the screen.  
Only press touch switches after confirming system safety.
- If touch switches are pressed in rapid succession, their inputs may not be successfully received.  
Confirm that the input of a touch switch has been successfully received before moving on to the next operation.

### Reference

Caution on pressing touch switches at 3 points

When multiple touch switches are created at the relative positions indicated in the example below, malfunctions may occur due to characteristics of this switch configuration.

Be careful about the positioning when setting touch switches.

Example 1 : When switches are created at positions A and B and at the points where the vertical and horizontal lines extending from these two points intersect, i.e. points C and D:

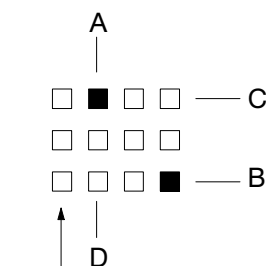

Smallest touch switch frame

- When switches A, B and C are switched on at the same time, switch D is also assumed to have been switched on due to the configuration of the touch switches.
- When switches A, B, and D are switched on at the same time, switch C is also assumed to have been switched on due to the configuration of the touch switches.

### 4-7-1 Functions of Touch Switches

Touch switches are created using rectangular elements. A touch switch can comprise more than one touch switch element. Up to 256 touch switches can be registered on one screen.

NT620S: 32 horizontally × 16 vertically  
 NT620C: 32 horizontally × 24 vertically

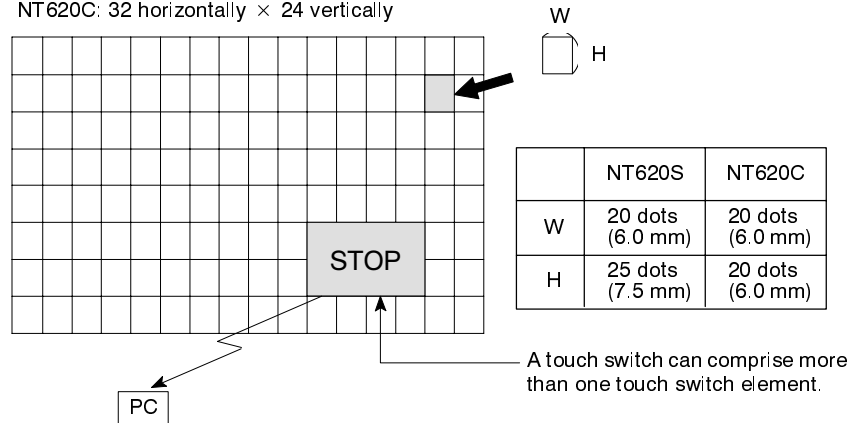

When the touch switch is pressed, its information is sent to the PC.

- Functions of touch switches

Touch switches can have the following functions:

- PC notification function (page 237)
- Screen switchover function (page 165)
- Input key function (page 167)
- Copy key function (page 168)
- Cursor moving key function (page 168)
- Screen print key function (page 169)



**Touch Switch Attributes**

The following attributes can be set for the Touch Switches.

- Display frame

A display frame of the Touch Switch can be specified by the following two methods.

- Fixed-shape display frame

This is a frame displaying an area of display frame type that acts as Touch Switch. There are four kinds of display frames as shown in the Table below: "Standard", "Solid 1", "Solid 2", "No Display Frame" ("Solid 2" is only available with the NT620C).

When "No Display Frame" is selected, only the label is displayed (or nothing if no label is specified) unless an ON (or flash) instruction is sent from the PC, or the touch switch is pressed.

Display Frame Type	Switch OFF	Switch ON
Standard		
Solid 1		
Solid 2		
No display frame		

- Free-shape display frame

This is a display frame capable of freely setting the display position and shape irrespective of Touch Switch area. A shape to be specified can be selected out of "Square", "Circle", "Polygon", and "Fan".

For example, free-shape display frame can be used in the following manner.

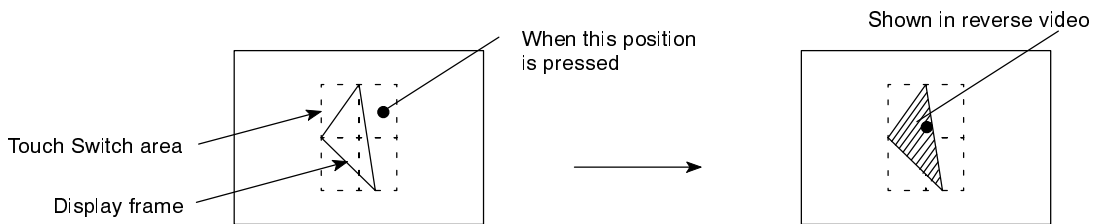

<Example of setting a display frame inside the Touch Switch area>

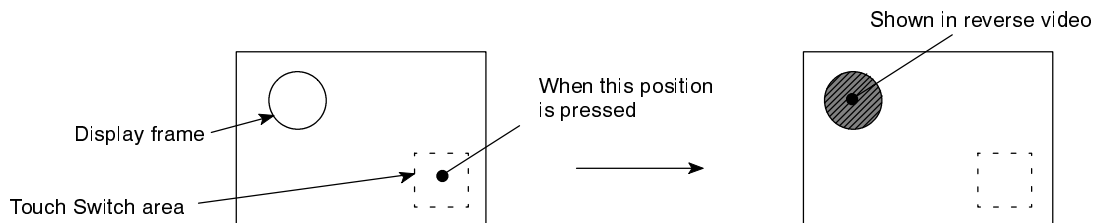

<Example of setting a display frame outside the Touch Switch area>

- Reverse display on input

It is possible to set a touch switch so that its display will be inverted when it is pressed.

- Guide display

Labels can be assigned to touch switches. When the touch switch is ON, the label is displayed in reverse video in the case of an NT620S and in the exclusive XOR color (see page 126) in the case of the NT620C. Attributes of guide display characters are in the same way as character display. Refer to “Character Types and Attributes” (page 140).

- Lit and flashing

This attribute can specify whether or not the Touch Switch is allowed to be ON or flashing when the Touch Switch is ON or flashing according to an instruction from the PC.

- Color display (NT620C only)

External frame color (when displayed): 8 colors

OFF color: 8 colors or “transparency”

Lit/Flashing, entry color: 8 colors

## 4-7-2 Stand Alone Functions

The NT620S/620C can switch over the screen only by operating the switches without instructions from the PC. This function is referred to as “Stand Alone Function”.

When a screen data is created with the support tool, the screen number of a screen to be switched over is assigned to the input terminal of the touch switch. When the touch switch is pressed during operation, the screen of the number specified is displayed. At this time, the screen number just switched over is also notified to the PC.

Depending on the screen number allocated to it, a touch switch can be made to perform one of two functions:

- When a screen number in the range 1 to 2000 is specified:

Pressing the touch switches causes the display to switch to the screen with the specified number.

- When screen number “0” is specified:

The touch switch functions as the screen switchover return key. Setting this key allows you to return to the screen that was displayed immediately before the current screen.

[Screen number in the range 1 to 2000 set]

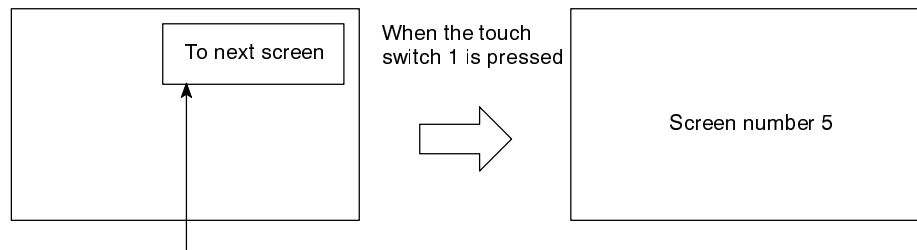

“Screen number 5” is set to the touch switch 1

[Screen number in the range 0 set]

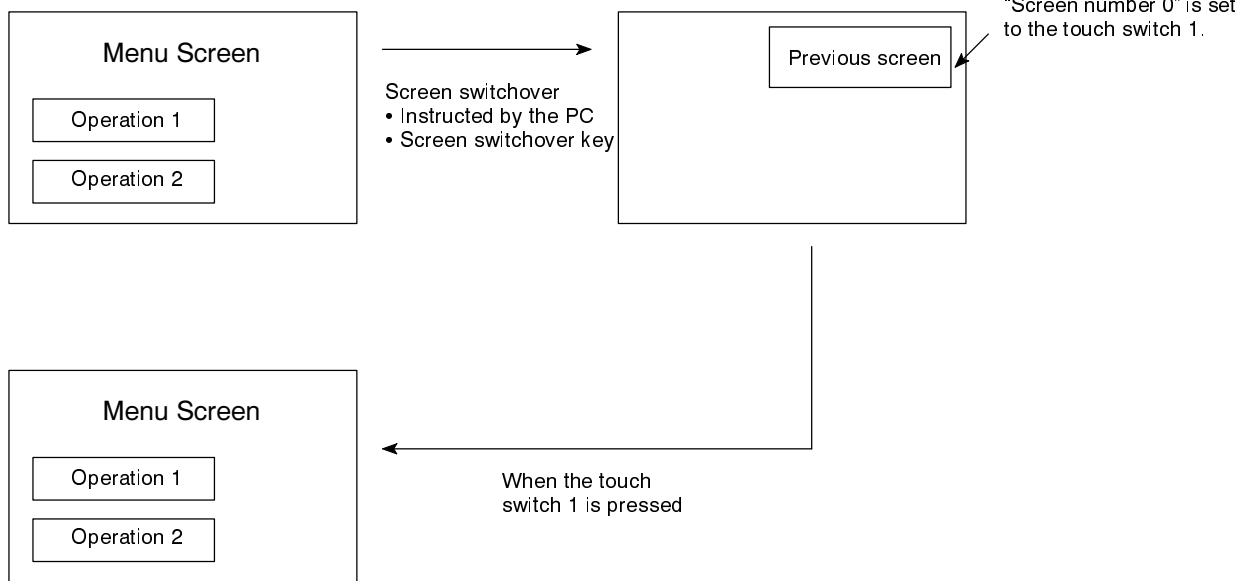

Only a touch switch can have the screen switchover return key function. If display of screen number “0” is specified from the PC, the screen will go blank.



The number of screens that can be returned using the screen switchover return key is a maximum of 32 screens. However, it is assumed that the screen switchover return key has been set to all screens to be returned.

### 4-7-3 Input Key Function

This is a function that allows touch switches to be used for input and is mainly used when using numeral/character string setting functions. Input keys are classified into the following three types:

- Character keys: Used to input character strings when using a character-string setting function. For details, see 4-9 “Character-String Setting” (page 182).
- Window keys: Used to open and close windows when using the pop-up window function. Also used to switch between “keyboards” when using character-string setting functions. For details, see 4-9 “Character-String Setting” (page 182) or 4-10 “Pop-Up Window Function” (page 185).
- Control keys: Used for functions provided by the system, such as the numeric key function used with numeral setting functions, the system key functions provided with previous PT models, and special control functions. For details, see the next section “Functions of Control Keys”.

#### Functions of Control Keys

Key	Function
0 to 9, A to F	Used to input numerical values
CLR	Clears input numerical values and character-strings
±	Assigns the opposite sign to input numerical values
.	Used to input a decimal point
HOME	Used to move to the input field at the top left of the screen
↑, ↓, ←, →	Used to move to the next input field
	Confirms character input without shifting to another input field
	Stops the buzzer
↑, ↓	Screen switching of continuous screens, shifting to input fields
MENU	System menu display
CA	Used to cancel input (Cancel)
BS	Deletes the numeral or character immediately preceding the input cursor
DEL	Deletes the numeral or character at the input cursor location
◀, ▶	Used to shift the input cursor
ENT	Confirms input of a character (after confirmation, the cursor shifts to the next input field)
▲, ▼	Alarm list/history display page scrolling
▲, ▼	Alarm list/history line scrolling

#### 4-7-4 COPY Key Function

Table input column are copied into other Memory Table or the numeral/character-string setting input column (Refer to “4-8 Numeral Setting” and “4-9 Character-String Setting”). The COPY key is useful to set the numeral/character-string display to its initial state and to enter the same value (initial value, etc.) into the multiple numeral/character-string setting input column.

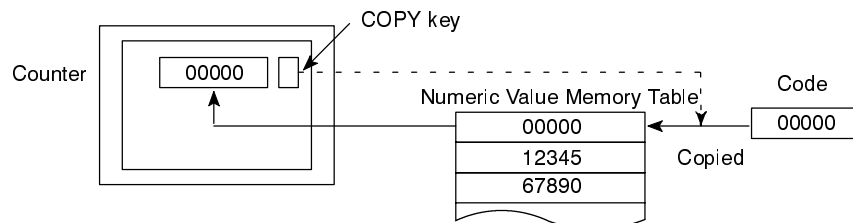

<Example that the COPY key is used as a RESET key for the counter>

Copy source (Memory Table or code) and copy destination (Memory Table or numeral/character-string setting input column) are specified.

#### 4-7-5 Cursor Moving Key Function

This is a Touch Switch to select the numeric value setting input column (ten-key type) and the character-string setting input column when entering data. When the Touch Switch is pressed, a cursor (display frame) is moved to the numeral/character-string setting input column specified to be ready for input operation (Refer to 4-8 “Numeral Setting” and 4-9 “Character-String Setting”). The numeric value/character-string setting input column is automatically produced with the Support Tool. Note that it is also possible to set the pop-up window “open” function for the same touch switch.

### 4-7-6 SCREEN PRINT Key Function

When the Touch Switch is pressed, a screen hard copy (screen image) is printed by a printer connected to the NT620S/620C.

Two kinds of keys can be set: START key that starts the printing operation and CANCEL key that cancels the printing operation.

Even when the screen hard copy is being carried out, the NT620S/620C continues operation.

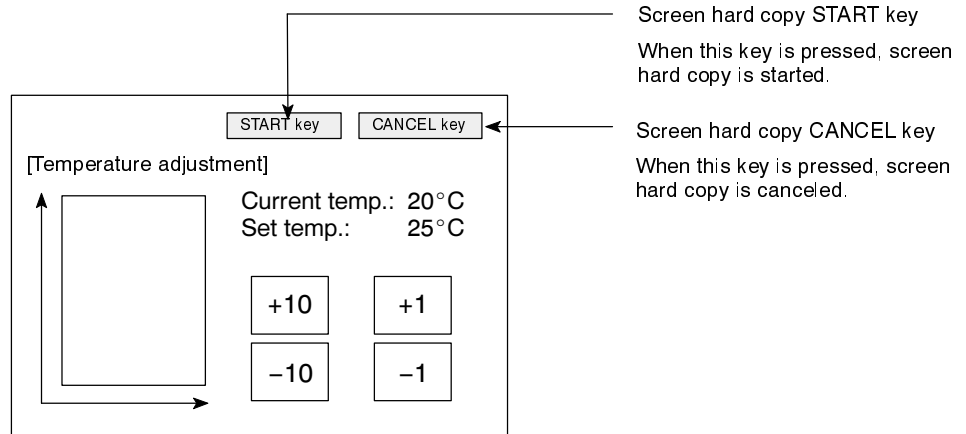

## 4-8 Numeral Setting

The numeral setting is a function to enter the numeral values on the screen. The numeral setting allows the numeral value to be entered directly from the touch switch into the numeral memory table, to be displayed in the screen, and further to be sent to the PC.

The following is a guide to the numeral setting function, a guide to the method for creating the numeric keys required for numeral settings on the screen, and an explanation of how to use numeric keys during operations.

Numeral setting screens cannot be registered as child screens of continuous screens.

In the case of overlapping screens, only one screen can be set as a numeral setting screen.



**Caution**

In order to input numerical values using touch switches, apart from the display area for the numeral setting, the numeric keys must also be created. For details on how to create numeric keys, see “Notification of Numbers to the PC” (page 241).

Ensure the safety of the system before changing the monitor data.

For the actual method used to notify the PC of input numerical values, see “Notification of Numbers to the PC” (page 241).

The numeral setting is carried out when a screen is created with the support tool.

### 4-8-1 Numeral Setting Functions

The numeral setting has the following functions.

**Basic Operation**

The numeral setting operation is as follows:

- (1) A numeral value is entered from the touch panel.
- (2) The numeral value entered is displayed in the numeral setting area in a screen.
- (3) When the numeral value entered is confirmed, it is written into the numeral memory table and simultaneously sent to the PC.

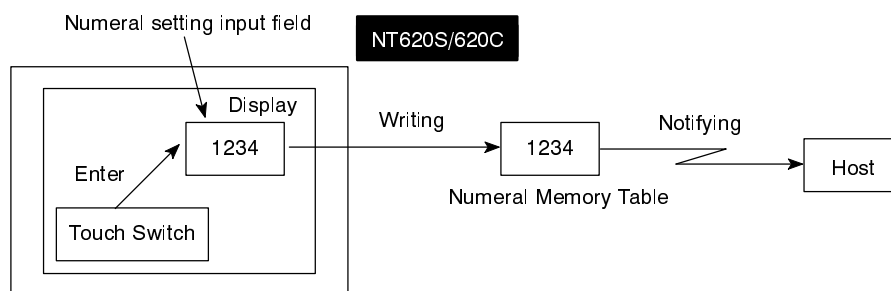

**Reference**

It is possible to disable input to a numeral setting input field by using a system control (PT status control area) operation (see page 257).



**Numerical Values that can be Input and Attributes that can be Set**

Numeral values up to 8-digit (up to 7-digit for negative numbers) can be entered in decimal and hexadecimal notation.

- Entry of decimal number

When the display attribute is set to decimal number display, a numeral value can be entered in decimal.

- Range of numeral values

Range of numeral values that can be entered differs depending on a sign.

With a sign not displayed: 0 to 99999999 (8-digit)

With a sign displayed: -9999999 to +99999999 (7-digit negative number, 8-digit positive number)

For a thumb wheel type, numeric values are up to 7-digit for both positive and negative numbers with signs displayed.

- Decimal point

To the right of the decimal point, a maximum of 7-digit can be entered (up to 6-digit for negative numbers).

- Entry of hexadecimal number

When the display attribute is set to hexadecimal number display, a numeral value can be entered in hexadecimal.

- Range of numeral values

Range of numeral values that can be entered is from 0 to FFFFFFFF (8-digit).

- Attributes that can be set

The attributes that can be set for numerical values displayed in input fields are the same as those for numeral displays. See "Numerals which can be Displayed" (page 142).

**Checking the Upper/Lower Limit**

When the upper limit and lower limit of the input numeral values have been set, erroneous numeral values outside of the range can be prevented from being stored in the numeral memory table or notified to the host.

**Caution**

When the numeral values entered are confirmed, upper/lower limits are checked. Otherwise the system may operate unpredictably.

### 4-8-2 Type of Numeral Setting

There are two kinds of types of numeral setting: ten-key type and thumb wheel type. Though basic functions are the same, screen displaying and inputting methods differ between two types.

A maximum of 50 input fields (combined total for both numeric key type and thumb-wheel type) can be registered on one screen.

#### Ten-key Type

When any numeral value is entered by the ten-key (character key) assigned to the touch switch, a numeral value just entered is displayed in a screen. When the RETURN key is pressed after an input operation is completed, the numeral value entered is written into the numeral memory table and then notified to the PC.

When there are multiple numeral setting input columns, a numeral setting input column for input operation is also selected by the ten-key.

To use the ten-key type, it is necessary to create not only the numeral setting input column in a screen but also the ten-key for input operation (Refer to page 173).

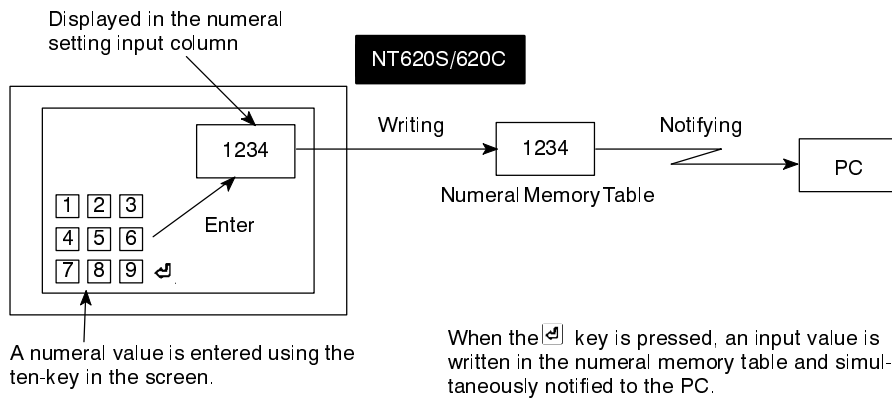

#### Thumb Wheel Type

By means of touch switches that can be increased/decreased every digit of numeral value, a numeral value can be entered from the numeral setting input column. Every time a numeral value displayed is changed, the numeral value displayed is written into the numeral memory table and simultaneously notified to the PC.

Therefore, the thumb wheel type can perform an entry of numeral value only by creating the numeral setting input column in a screen.

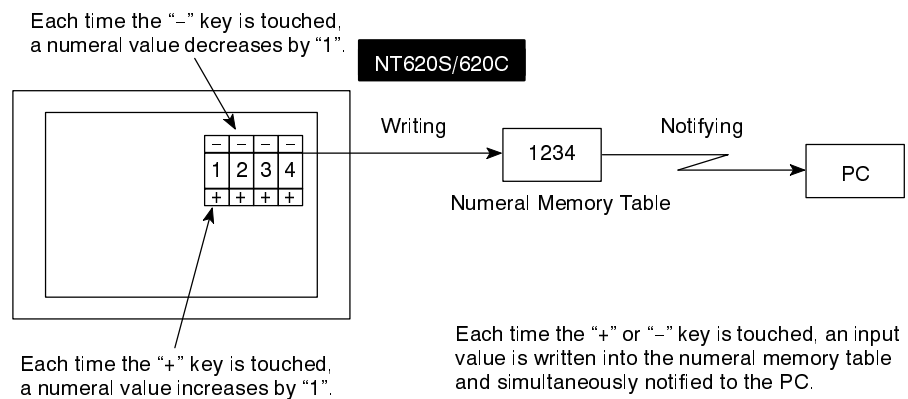

### 4-8-3 Ten-Key Creation

In order to use the ten-key type numeral setting, it is necessary to create not only the numeral setting input column in a screen but also a ten-key for performing an input operation.

#### Screen Attribute Setting

A ten-key type can be selected by setting a screen attribute.

The “Numeral Setting” of the screen attribute is specified to “System” or “User”.

- Screen when “System” is specified

When a numeral setting input field is created, numeric keys are automatically displayed.

Ten-key display position and arrangement are fixed. In this screen, only the type of ten-key (system key) in the following page can be used.

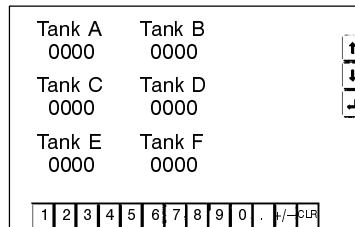

- Screen when “User” is specified

Display position and arrangement of the ten-key can be set freely by assigning to the touch switch (Refer to page 174).

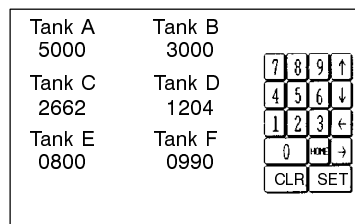

When the “numeral setting Keypad” attribute is “user”, the numeric keys are created by using the control keys of the touch switch “input key” function. It is also possible to use the character keys of the “input key” function to create numeric keys with one-byte characters 0 to 9 and A to F.

**Reference**

Even when the “Numeral Setting” of the screen attribute is “User”, the same ten-key as the “System” attribute can be displayed.

When the “User Ten-Key” of the “Input Setting” is specified to create data for the “Numeral Setting” screen, the following ten-key is displayed:

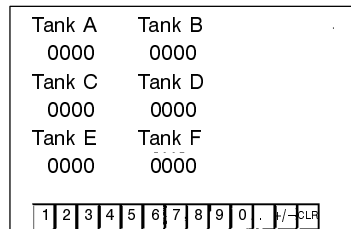

**Allocation of Ten-key**

Ten-key can be allocated to the touch switches.

Specify the numeric keys to be allocated to touch switches when creating the touch switches. For numeral settings, the following numeric keys (system keys) can be used.

For creation of the touch switch, refer to the 4-7 “Touch Switches” (page 161).

Ten-key	Ten-key	Ten-key (system key)
0	A	↑
1	B	↓
2	C	←
3	D	→
4	E	☑
5	F	☒
6	CLR	↑↓
7	+/-	↑↓
8	.	MENU
9	HOME	

\* “MENU” means the system menu display.

When any touch switch allocated to the ten-key and system key in the numeral setting screen is pressed, it will not be notified to the PC.

### 4-8-4 How to Use Ten-Key Type

In order to enter the numeral values using the ten-key type, the numeral setting input column subject to entry is specified to be ready for input operation before entering the numeral values using the ten-key.

#### Specifying the Numeral Setting Input Column to be Entered

The numeral setting input column to be entered is specified by either ten-key, system key, or touch switch (cursor moving key).

The frame (cursor) around the specified numeral setting input column and the cursor attributes can be specified.

- Specifying the column using the ten-key

The numeral setting input column is specified with the HOME,  $\rightarrow$ ,  $\leftarrow$ ,  $\uparrow$ ,  $\downarrow$  keys out of the ten-keys. A cursor can be moved between the numeral setting input columns by these keys as shown below.

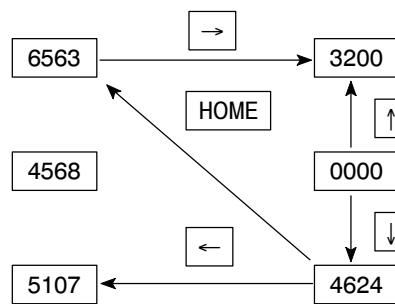

When the HOME key is pressed, the cursor can be moved at a stretch to an area at the upper left corner where a sum of XY coordinates is at a minimum (the numeral setting input column at the upper left in the example above).

- Specifying the column using the system key

When the system keys  $\uparrow$  and  $\downarrow$  of the touch panel, a cursor can be moved in the order that the numeral setting input column is created by the support tool.

For example, when three numeral setting input columns are created, a cursor can be moved in due order as follows:

$\uparrow$  key: First  $\rightarrow$  Second  $\rightarrow$  Third  $\rightarrow$  First

$\downarrow$  key: First  $\rightarrow$  Third  $\rightarrow$  Second  $\rightarrow$  First

When the “Numeral Setting Screen” for the screen attribute is set to “System”, the order of movement using the system keys  $\uparrow$  and  $\downarrow$  can also be changed. For details, refer to NT-series Support Tool Operation Manual (V028-E1-□).

- Specifying the column using the cursor moving key

With the cursor moving key of the touch switch being set, the numeral setting input column can be specified only by touching the key.

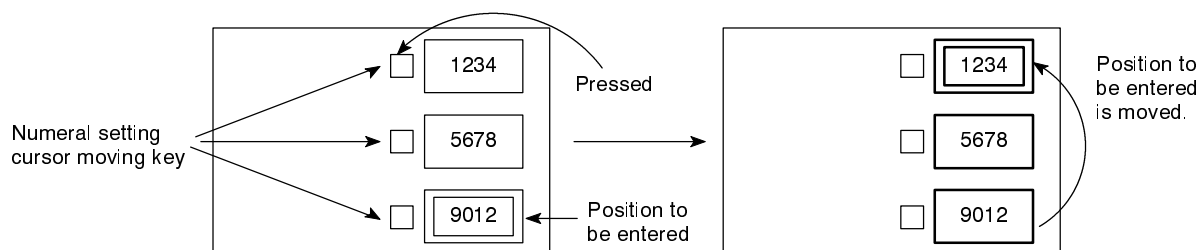

**Reference**

- When using Ver.2.□ of the NT-series support tool, cursor moving keys can be automatically created as touch switches associated with the input fields when numeral setting input fields are created.
- The pop-up window function (“open”) can also be assigned to the cursor moving keys (if the keys are created automatically, this function can be set by modification).

**Entering the Numeral Values**

The numeral values are entered using the ten-key numeric (0 to 9, A to F), decimal point (.), sign (+/-), clear (CLR), RETURN (↵) keys.

The numeral values can be entered in the same manner as a general electric calculator as follows:

- Entering the integer part and decimal fraction

An integer part is entered from the least significant digit. When an input numeral value is in excess of display digits, the numeral value shifts to the left from the least significant digit.

When a decimal point is entered, a decimal fraction can be entered thereafter. The decimal fraction is entered from the most significant digit. When an input numeral value is in excess of display digits, the numeral value shifts to the right from the most significant digit.

Key Entry	Numeral Value Display
(Initial state)	1234.5678
1	2341.5678
2	3412.5678
.	3412.5678
4	3412.4567

- Changing the sign

In case of sign display setting, the sign alternates from “+” to “-” and vice versa, each time the sign (+/-) key is pressed.

- Confirming the input numeral value

Be sure to press the RETURN key after an input operation is completed. When the RETURN key is pressed, the numeral value displayed is written into the numeral memory table and simultaneously notified to the PC.

- Initial operation of the input keys

When the sign (+/-), and decimal point(.) keys are pressed initially (when pressing these keys immediately after displaying a screen or inputting the keys), the NT610C will operate as follows:

- Sign (+/-) key

The display is cleared by "0", but the sign is not reversed (when entering a decimal number or displaying a sign).

- Decimal point (.) key

The display is cleared by "0". The NT620S/620C starts entering the decimal fraction (when entering a decimal number or displaying a decimal fraction).

- Checking the upper/lower limits

The upper/lower limits are checked when pressing the RETURN key after an input operation is completed. If it is found that an input numeral value is in excess of limit as a result of checking, the contents of the numeral memory table (previous values prior to entry) is displayed again, but this is not notified to the PC.

- Example of input

Numeral display varies as shown below when actually entering numeral values.

Input example 1) In case of decimal notation, sign displayed, integer part 4-digit, decimal fraction 3-digit

Order	Key	Numeral Display	Order	Key	Numeral Display	Order	Key	Numeral Display
Initial value		0000.000	7	A	-1524.000	14	.	0000.000
1	1	0001.000	8	.	-1524.000	15	7	0000.700
2	5	0015.000	9	1	-1524.100	16	2	0000.720
3	2	0152.000	10	5	-1524.150	17	↵	0000.720
4	B	0152.000	11	2	-1524.152	18	±	0000.000
5	±	-0152.000	12	7	-1524.527	19	1	0001.000
6	4	-1524.000	13	↵	-1524.527	20	±	-0001.000

Input example 2) In case of decimal notation, sign not displayed, integer part 4-digit, decimal fraction 3-digit

Order	Key	Numeral Display	Order	Key	Numeral Display	Order	Key	Numeral Display
Initial value		0000.000	5	±	0152.000	10	↵	1524.130
1	1	0001.000	6	4	1524.000	11	.	0000.000
2	5	0015.000	7	.	1524.000	12	9	0000.900
3	2	0152.000	8	1	1524.100	13	5	0000.950
4	B	0152.000	9	3	1524.130	14	↵	0000.950

**Reference**

Using touch switches set as copy keys (see page 168) allows you to input the value or code (constant) in a numeral memory table into a numeral setting input field in a one-touch operation.

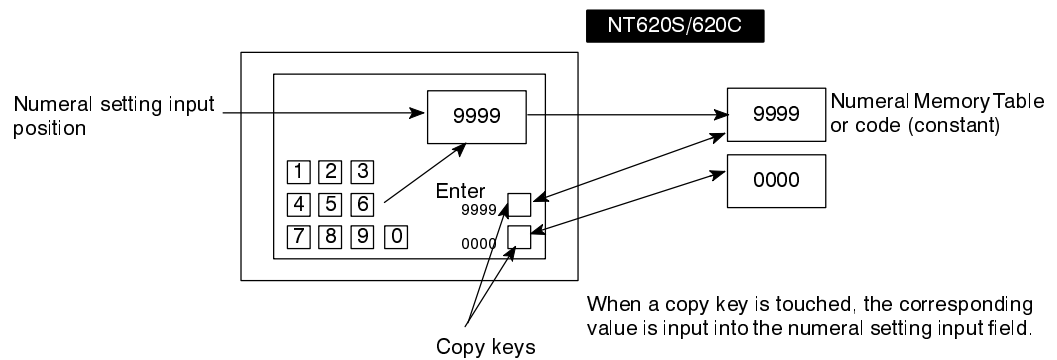



### 4-8-5 How to Use a Thumb Wheel Type

For numeral setting of thumb wheel type, a numeric value is entered by directly touching the increment/decrement (+, -) keys. Keys such as ten-key are not required.

#### Entering the Numeric Values

The numeric values are entered using the increment/decrement (+, -) keys provided at each digit.

- Specifying the numeric values

When the increment/decrement (+, -) key is touched, the numeric value at that digit will increase/decrease by “1”. Each time “+” or “-” key is touched, the numeric value just changed is notified to the PC. It is not necessary to press the RETURN (↵) key unlike the ten-key type.

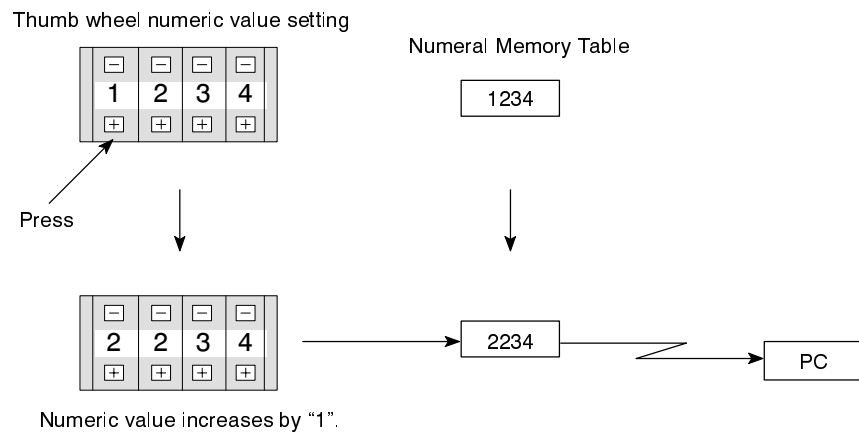

A numeric value cannot be entered into the thumb wheel type from the ten-key.

- Changing signs

In case of sign display setting, the sign “+” is specified by touching the “+” key of the digit for which the sign is displayed and the sign “-” by touching the “-” key.

- Checking the upper/lower limits

Upper/lower limits are checked when pressing the increment/decrement (+, -) keys. If it is found that an input numeral value is in excess of the limit as a result of checking, the contents of the numeral memory table (previous value before pressing the increment/decrement (+, -) keys) is displayed again, but this is not notified to the Host.

However, with thumbwheel type numeral setting, if the situation is such that with an upper limit of  $1n..n$ , and a lower limit of  $0m..m$  (where  $n$  and  $m$  are the values of each digit),  $n..n < m..m$ , it is not possible to carry digits upward or downward.

Example:

When the upper limit value is 1200 and the lower limit value is 201, if the initial value has three digits the value can be changed within the range 201 to 999, and if the initial value has four digits it can only be changed within the range 1000 to 1200.

This is because if an attempt is made to change the leftmost digit from 0 to 1, or from 1 to 0, an upper/lower limit value check is always performed.

In order to avoid this, either set the values so that  $n..n \leq m..m$ , or create another touch switch and write values to it when digits are carried up or down.

## 4-8-6 Setting Items for Numeral Setting

For the numeral setting, the following items are set when being created with the support tool. However, for numeral setting of thumb wheel type, there are some restrictions on the setting of several items.

### Items to be Set

- Numeral Memory Table to be referred

The number of the numeral memory table is specified to register the numeric values entered for the numeral setting.

- Number of digits of numeric value entered

The number of digits of numeric value entered is specified. Up to 8-digit can be specified by figuring out a sum of the number of digits of both integer part and decimal fraction. However, when displaying a sign, the number of negative numbers is limited to a maximum of 7-digit.

- Upper/lower limit

Upper limit and lower limit are set separately. A maximum of 8-digit numeric value (up to 7-digit for negative numbers) can be set.

To set a negative value for the upper or lower limit value, set "F" for the eighth digit.

Example: If the upper limit value or lower limit value is "-123" → "F0000123".

- Display attribute

The same attributes as the numeral display are set. For details, refer to the "Numerals which can be Displayed" (page 142).

**Restrictions and Additions when Creating the Thumb Wheel Type**

For numeral setting for thumb wheel type, there are the following restrictions and additions when setting the items.

- Number of digits of positive numbers to be entered with a sign displayed

For the thumb wheel type, with a sign displayed, the number of digits of the positive numbers to be entered is also a maximum of 7-digit.

- Display size

There are only three kinds of size that can be specified. Size is specified by the touch switch size of the increment/decrement (+, -) keys. Display size is selected out of three size: minimum unit of touch switch (NT620S: 20 dots by 25 dots, NT620C: 20 dots by 20 dots ), 1 x 1 (small), 2 x 2 (medium), 3 x 3 (large). Entire size of the numeral setting input column is specified by the touch switch size just specified.

- Shape (end plate)

Either of the two kinds of shape as shown below can be set. Decoration (end plate) at both ends of the numeral setting input column differs.

<With end plate>

<Without end late>

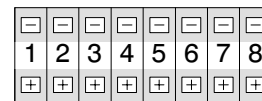

- Restricted display attributes

There are the following restrictions on display attributes.

- Character type: Wide size only
- Character magnification: Either of double, x4, or x9 in correspondence with display size specified
- Character display attribute: Normal display only (“reverse” and so forth are not available)
- Zero suppress: “Without zero suppress” only

For details, refer to the “Numerals which can be Displayed” (page 142).

## 4-9 Character-String Setting

NT620S/620C has a function of character-string setting to enter a character-string on a screen.

The character-string setting allows a character-string to directly be entered from the touch switch into the character-string memory table, displayed in the screen, and also sent to the PC.

This section outlines the character-string setting function and explains how to input character-strings during operation. The character-string setting function can only be used when using Ver.3 or a later version of the direct connection function.

For the actual method used to ascertain input character-strings at the PC, see "Notification of Character-string to the PC" (page 244).

The character-string setting is carried out when creating a screen with the support tool.

### 4-9-1 Functions of Character-String Setting

The character-string setting has the following functions.

The NT610C operates the character-string setting as follows:

- (1) The touch switches (character key) are previously set by the support tool.
- (2) When the character key ("NT620S" in an example in the figure) is pressed, a guide character of the character key ("NT620S" in the example in the figure) is entered in the character-string setting input column.
- (3) When the Enter (  ) key is pressed, the character-string of the character-string input column is written into the character-string memory table and simultaneously notified to the PC.

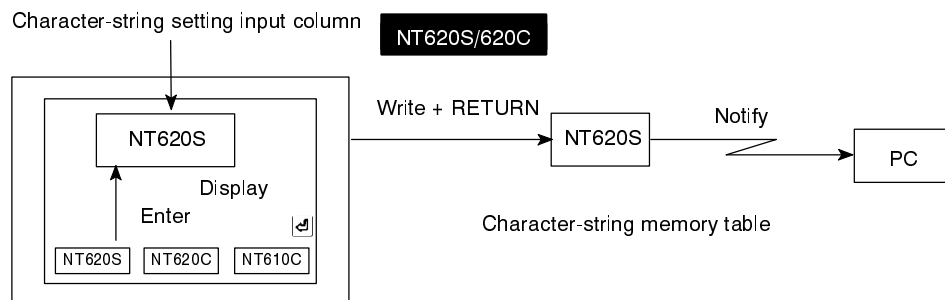

#### Reference

- By using the pop-up window function (see page 185), it is possible to select and open a number of windows (keypads), each of which comprises a number of character keys, thus allowing various types of input.
- Input to character-string setting input fields can be disabled by a system control (PT status control area) operation.

**How to Enter the Character-Strings**

An appropriate character-string setting input column is specified to be ready for an input operation before a character-string is entered by the character key.

- Specifying the character-string setting input column to be entered

The character-string setting input column to be entered is specified by either ten-key, system key, or touch switch (cursor moving key).

The frame (cursor) around the specified character-string setting input column and the cursor attributes can be specified.

Concrete specifying method is the same as numeral setting. Refer to the “Specifying the Numeral Setting Input Column to be Entered” (page 175).

**Reference**

The window opening function can be set for cursor moving keys. For details, see 4-10 “Pop-Up Window Function” (page 185).

- Entering the character-string

The character-strings are displayed in the input column of the character-string setting in due order of the touch switches being pressed (A character is inserted at an input cursor position). At this time, the keyboard screen can also be switched over halfway.

When entering the character-strings, the following control keys of the touch switches can be used.

Control Key	Function
CA	Used to cancel character-string entry
BS	Used to delete a character just before an input cursor
DEL	Used to delete a character at an input cursor
◀	Used to move an input cursor to the left by one character
▶	Used to move an input cursor to the right by one character
ENT	Used to confirm an input character (After confirming this, a cursor moves to the following input column)

Be sure to press the Enter (  ) key after an input operation is completed. At this time, the character-strings being displayed are written into the character-string memory table and simultaneously notified to the PC.

**Note**

In order to make character-string settings, a key to confirm character-string input is required. Allocate the Enter (  ) or ENT control key to a touch switch to create this key.

**Reference**

- It is also possible to use the control keys of the input key function (however, the four keys used for alarm display cannot be used).
- By switching between windows, a large number of character keys can be used. It is also possible to create a temporary input field in a window to allow the existing data to be checked while inputting new data. For details, see 4-10 “Pop-Up Window Function” (page 185).
- Using copy keys (page 168) allows you to input the value or code (constant) stored in a character-string memory table into a character-string setting input field in a one-touch operation.

Example:

- When the “NT620S-” is pressed

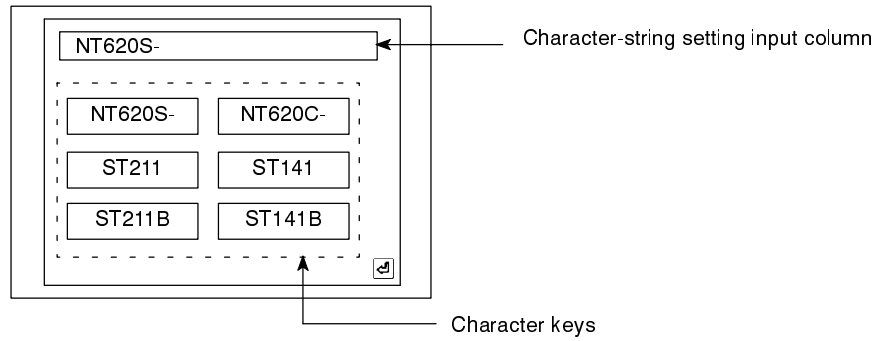

- Then, when the “ST211” is pressed

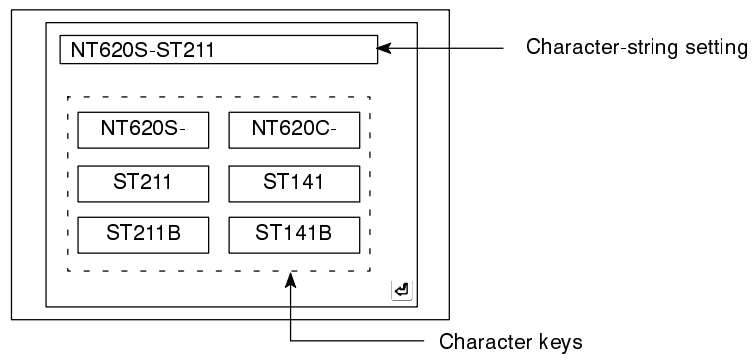

- Finally, when the Enter (  ) key is pressed, the “NT620S-ST211” being displayed in the input column of the character-string setting is confirmed and written into the character-string memory table and simultaneously notified to the PC.

## 4-10 Pop-Up Window Function

The NT620S/NT620C features the pop-up window function, which is used to display windows overlaying the currently displayed screen (base screen). These windows can be opened whenever required by pressing touch switches.

The pop-up window function can only be used with Ver.3 and later versions of the direct connection function.

### Reference

When using NT612G/NT610C, the windows can only be used as “keyboards”. The opening of windows can be disabled by a system control (PT status control area) operation.

### 4-10-1 Functions of Pop-Up Windows

The functions of pop-up windows are described below.

#### What is a Window?

A “window” is a screen that can be displayed overlaying a currently displayed screen (the base screen). Its size and display position can be changed without restriction. Windows are mainly used for the following applications.

- An explanatory message can be registered in a window, enabling it to be used as a HELP screen during an operation.

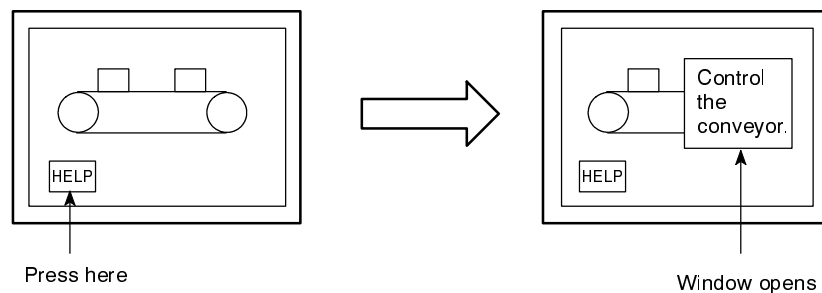

- By registering multiple character keys (touch switches) for use in character-string setting, windows required for specific purposes can be displayed whenever necessary, allowing various types of input.

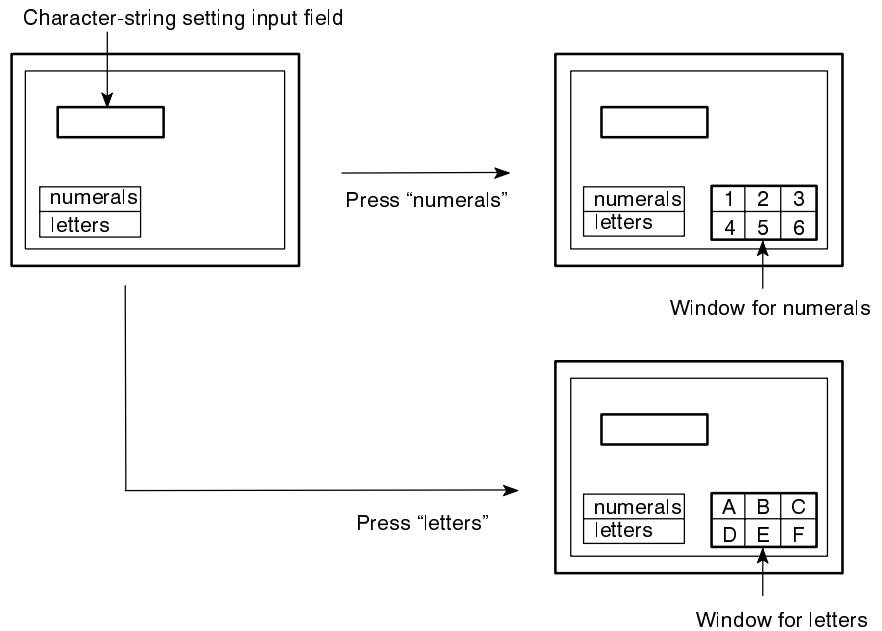

**Note**

In order to make character-string settings, a key to confirm character-string input is required. Allocate the Enter (  ) or ENT control key to a touch switch to create this key.

- By registering multiple screen switching keys (touch switches), menus for screen switching can be created.

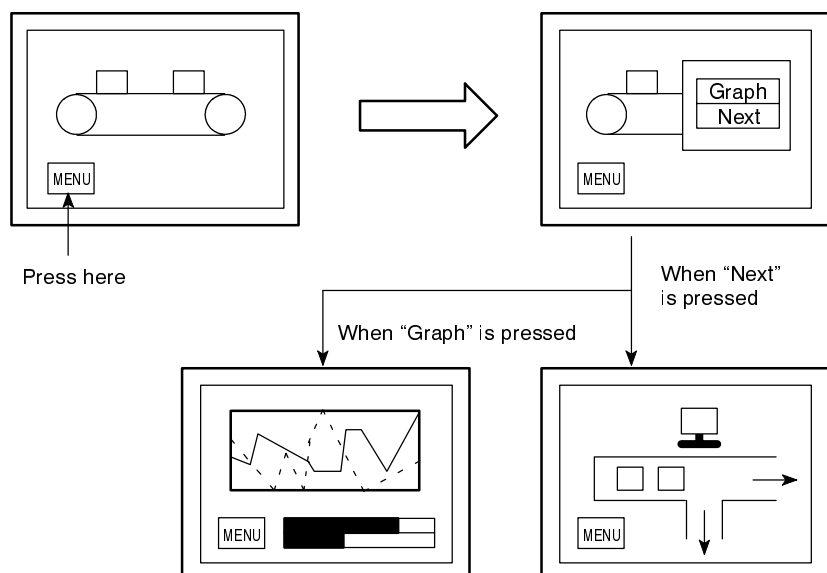



## Window Screens and Display Elements

Using the pop-up window function, windows can be created in the screens numbered 1900 to 1979 (note that a screen for which a window is registered is called a “window screen”). Screens other than these cannot be opened as windows. On returning to the “Screen List” screen after creating a window in the screen number range 1900 to 1979, specify the “window area (display area)” (The window will then open in a display area of the specified size and at the specified position).

The following elements can be displayed in NT620S/NT620C windows. If elements other than these are registered on a window screen, they will not be displayed when the window opens.

- “Background color” screen attribute (NT620C only)
- Fixed displays
- Touch switches (but the input notification and screen print functions cannot be used)
- Numeral/character-string input setting fields (only one can be used)

Elements that project beyond the display area will not be displayed when the window opens. Similarly, display elements on the base screen that overlap even partly with the window will be deleted when the window opens.

### Note

- Since the pop-up window function and screen print function share the same memory area, it is not possible to open a window during screen printing. Conversely, a screen cannot be printed while a window is open.
- The display elements in a window cannot be notified to the PC. This means that the lamp bits of touch switches in windows cannot be controlled.
- While a window is open, display processing may be slightly delayed.

## 4-10-2 Opening and Closing Windows

Windows are opened and closed by using input keys: either the window keys or cursor moving keys.

### Opening and Closing Windows with the Window Keys

Window keys can be used in the following way to open and close windows (note that window keys can be created either on the base screen or in a window).

- Open: When the touch switch is pressed, the specified window opens. If another window is open when the touch switch is pressed, it is closed first before the specified window is opened. If the specified window is already open, nothing happens.
- Close: When the touch switch is pressed, the open window is closed.
- Open/Close: The specified window opened if it is not open, and closed if it is open. If another window is open, it is closed first and then the specified window is opened.

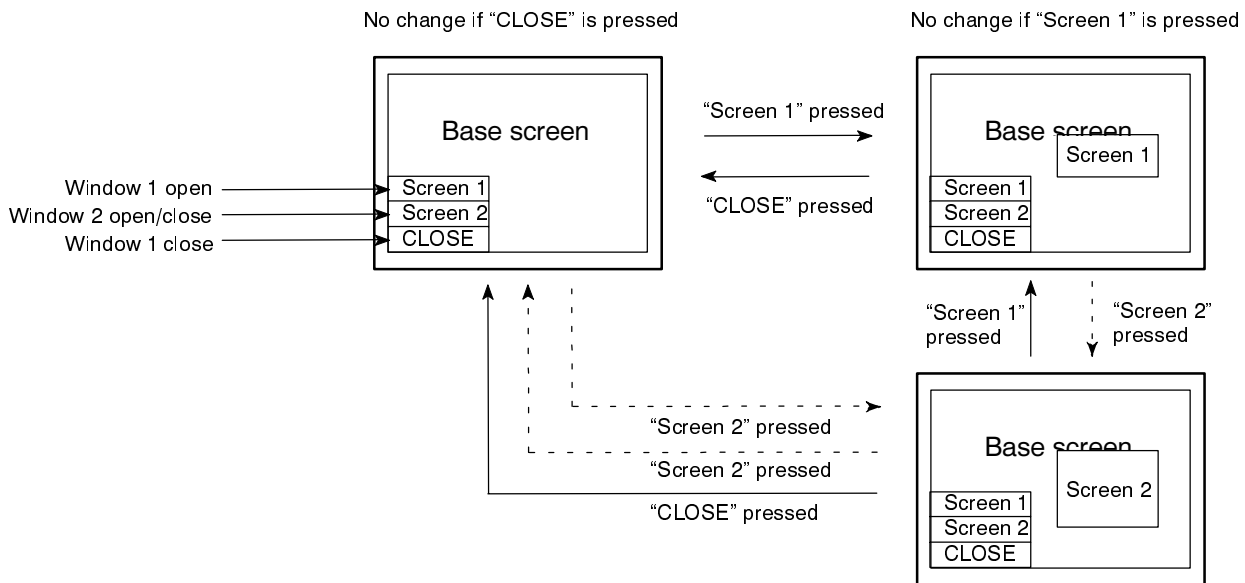

If an attempt is made to open a window that has not been registered, no window is opened (if a window is currently open, it will be closed).

It is not possible to open more than one window at the same time. If multiple child screens are registered for an overlapping screen, only the first child screen will be applicable.

On switching to another screen, an open window will be automatically closed.

**Reference**

When creating a screen with the support tool, it is possible to specify a window to be displayed when the screen is displayed (an initial window) by using the window display function of the input setting function.

**Opening Windows with the Cursor Moving Keys**

It is possible to set a window key "open" function for the cursor moving keys used for numeral/character-string setting, in addition to their cursor moving function. Doing this makes it possible to specify an input field and also display the window to be used in a one touch operation.

If another window is open when the cursor moving key is pressed, that window is closed first before the specified window is opened (the cursor also moves to the specified input field). If the specified window is already open, the cursor moves to the relevant input field but nothing else happens.

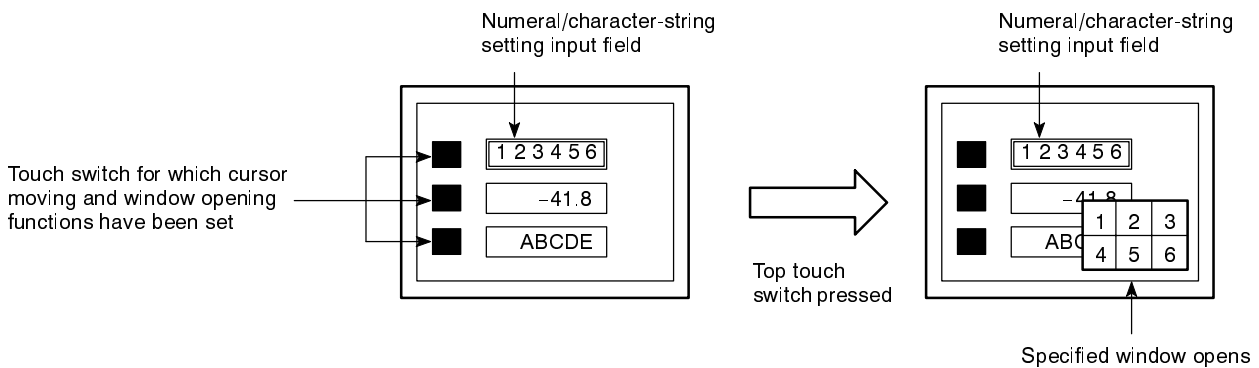

If the cursor moving keys are created automatically during creation of a numeral/character-string input field with the support tool, the window opening function is not set. In this case, the window to be opened can be specified by modifying the touch switch.

### 4-10-3 Temporary Input Fields

Only one numeral or character string setting input field can be registered for a window. This input field can be used - in combination with a number of numeral and character-string input fields on base screens - for provisional input before any data is input into the actual input field on the base screen. This kind of numeral or character-string input field in a window is called a "temporary input field". Its advantage is that entries can be input into the temporary input field while checking the current setting on the base screen.

However, if the temporary input field in the window and the input field on the base screen are not of the same type, the temporary input field will not be displayed. Note also that temporary input fields cannot be used for thumb wheel type input fields.

The temporary input field will also be unusable and not displayed if it has fewer digits than the actual input field on the base screen (number of integer digits + number of decimal fraction digits + digit for decimal point + digit for sign).

If it is not possible to use a temporary input field, the data has to be input directly onto the base screen.

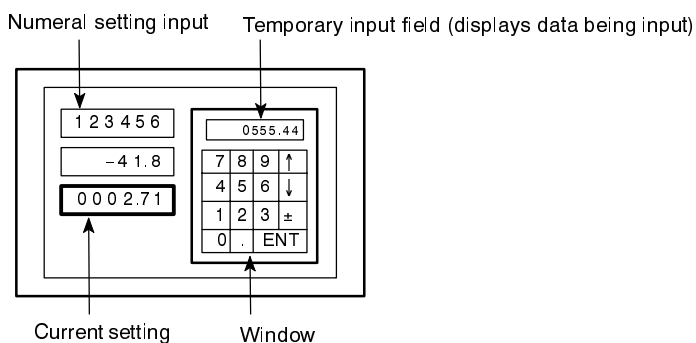

## How to Input Data Into Temporary Input Fields

Temporary input fields are used in the following way.

- (1) Specify the numeral/character-string input field used for actual input with a numeric key, system key, or touch switch (cursor moving key).

The actual method used for specification is the same as that for numeral setting. See “Specifying the Numeral Setting Input Column to be Entered” (page 175).

It is possible to display a window simultaneously with a cursor movement. For details, see “Opening Windows with the Cursor Moving Keys” (page 188).

- (2) If the window in which the temporary input field is registered is not displayed, open it (this could also be done prior to step (1)). For the method for opening the window, see “Opening and Closing Windows” (page 187).

The temporary input field displays the contents of the actual input field at that point in time. The display of the temporary input field is governed by the following attributes:

- Attributes determined by the settings for the temporary input field:

Character font, scale, display attribute, smoothing, character color, background color

- Attributes determined by the settings for the actual input field on the base screen:

Numbers of integer and decimal fraction digits, upper limit value, lower limit value, decimal/hexadecimal, zero suppress, sign display.

The cursor frame of the temporary input field is always displayed.

- (3) Input the numerical value or character-string. The method is the same as that normally used to input numerical values and character strings. See “Entering the Numeral Values” (page 176), or “How to Enter the Character-Strings” (page 183).

The numerical value or character-string is input into the temporary input field.

- (4) The input numerical value of character-string is written to the input field on the base screen on confirming it by pressing the ENT key or the return key (  ), and the contents of the corresponding numeral/character-string memory table are changed accordingly (notification to the PC also takes place at this time). The cursor moves to the next input field on the base screen.

If the input value is outside the range delimited by the upper and lower limit values, the original value is redisplayed.

Note also that if the actual input field on the base screen is changed before input is confirmed, the input data will be destroyed. The input data will also be destroyed if the window is closed or the screen is switched before confirmation.

Operation Example Temporary input operation example

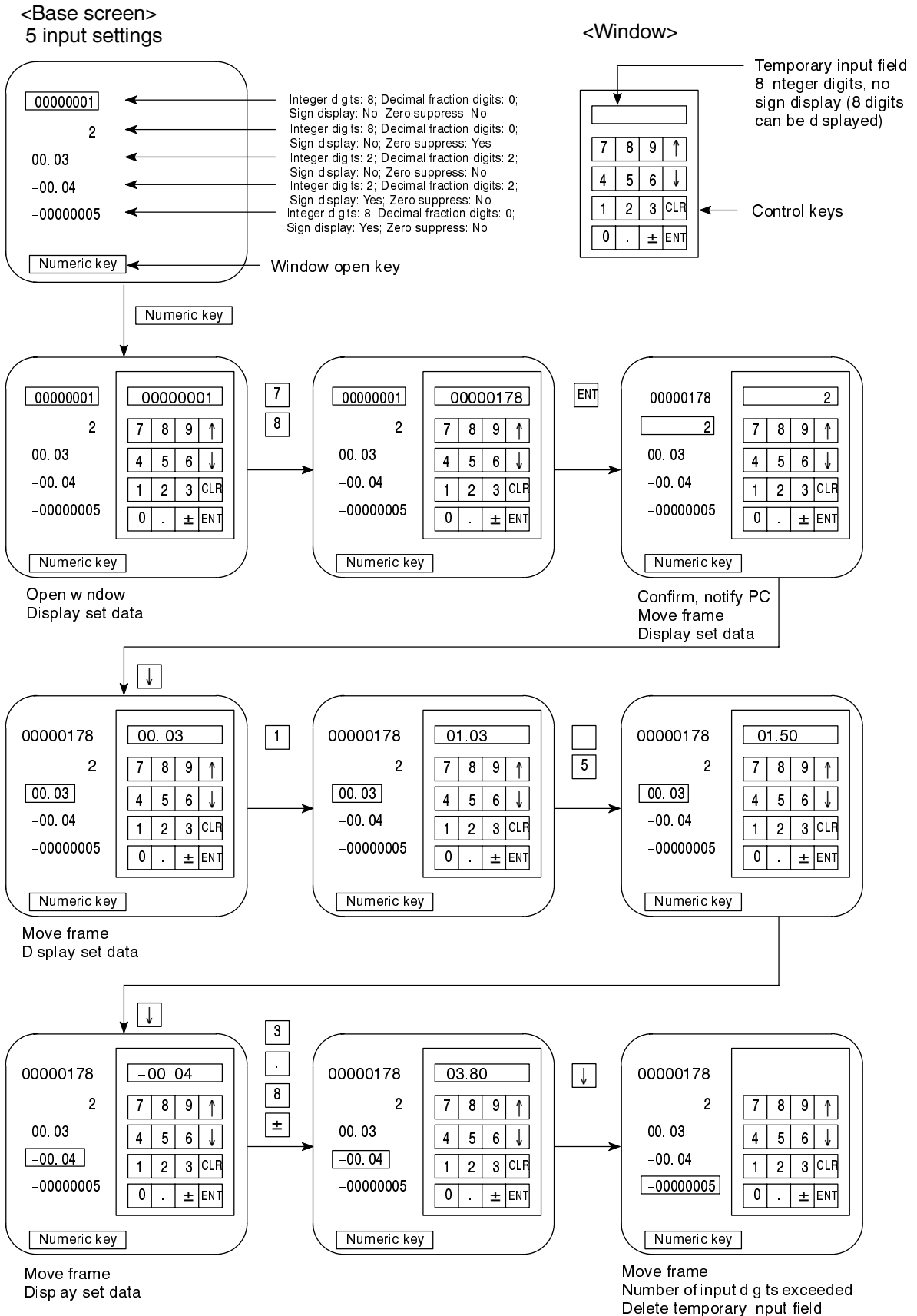

## 4-11 Alarm List & History Display Functions

The NT620S/620C can monitor the state of PC contacts of the host and display the corresponding message (using the character-string memory table) or image library (alarm list display) when particular contact becomes “1” (ON).

The NT620S/620C can record that those contacts become “1” (ON) and also display them in the order of frequency or occurrence (alarm history display).

### 4-11-1 Alarm List Display

Alarm list display has the following functions.

#### Displaying the Message (Character-String Memory Table) and Image Library

The NT610C monitors multiple contacts according to the setting of the bit memory table and displays the character-string memory table (message) set to the corresponding bit memory table when there is any contact that becomes “1” (ON). Since the display column of a message is also a touch switch, corresponding image library can be displayed by pressing the message being displayed.

If the description of alarms is provided in the character-string memory table and the corrective actions against those alarms are described in the image library, it is possible to take appropriate measures rapidly.

- To display multiple messages

When multiple contacts become “1” (ON), the bit memory table with smaller table number is displayed preferentially.

When multiple messages can be displayed, the messages of higher priority (smaller bit memory table number) will be displayed earlier.

The display column of message and the image library displayed correspondingly are referred to as “Alarm Group” collectively. The NT620S/620C can display up to four individual alarm group in one screen and simultaneously show up to the following messages in one alarm group.

NT620S:	Max. 16 pcs.
NT620C:	Max. 24 pcs.

Example:

Message (character-string No. 32)  
set to bit memory table number 14

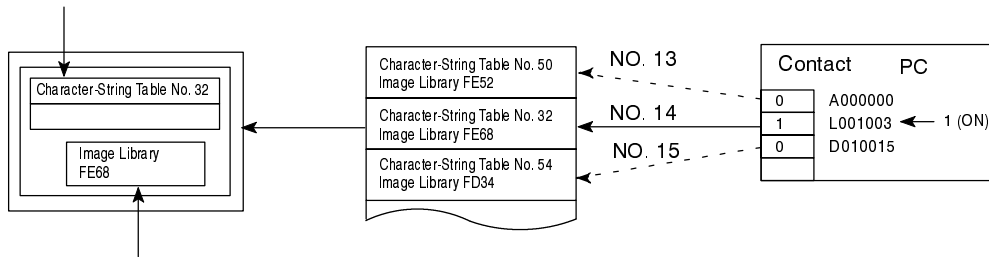

When the message displayed is pressed, the image library (FE68) set to the bit memory table number 14 is displayed.



Now, when the contact A000000 turns ON

Message (character-string 50) set to  
bit memory table number 13

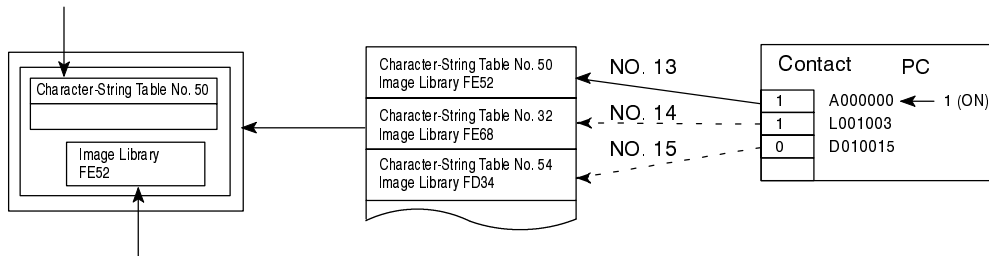

When the upper message displayed is pressed, the image library (FE52) set to the bit memory table number 13 is displayed.

When the contact corresponding to the message being displayed returns to “0” (OFF), the message is cleared and the next message is displayed according to the order of priority.

- Scrolling the message

When the message issued extends more than the number of lines set to message display, the message being displayed can be scrolled in unit of line or page.

When the number of lines for message display is set to four or more, the control keys for scrolling are automatically created as shown below.

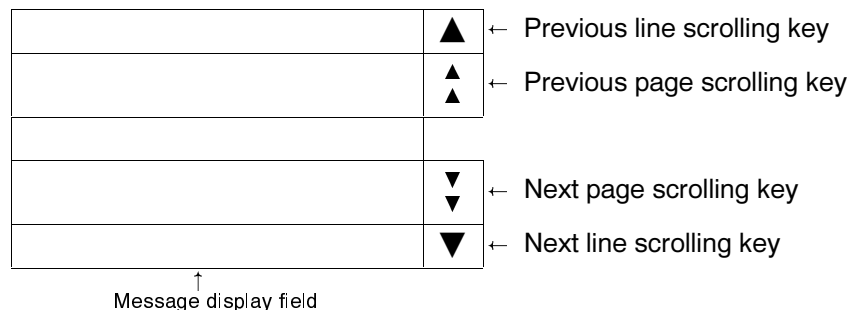

When the number of lines for message display is set to one to three, only line scrolling keys are automatically created.

The scrolling key can also be set and corrected by the “Control” out of the “Input Key” functions of the touch switches.

- Scrolling keys shown in reverse video

Since these scrolling keys are automatically shown in reverse video when there are any messages in front or behind those keys, it is found whether or not there are any messages that are not displayed.

**Switching the Image Library to be Displayed**

The message display column also serves as a touch switch. By selecting the message (touch switch) displayed, corresponding image library can be displayed.

**Switching over to the Corresponding Screen**

To the bit memory table used for the alarm list display function, corresponding screen number can be set, as well as corresponding character-string memory table (message) and image library.

When the screen number has been set, by pressing the message once again that is being selected in the section above “Switching the image library to be displayed”, it is possible to switch over to and display that screen.

Example:

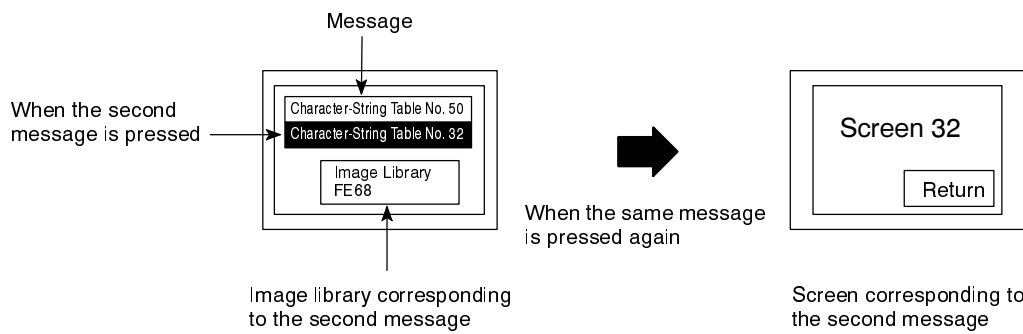

**Setting the Alarm List Display Function (Setting the Bit Memory Table)**

When the alarm list display function is used, it is necessary to set the bit memory table and screen display function. This paragraph describes the setting of the bit memory table. For the display setting, refer to “NT-series Support Tool Operation Manual” (V028-E1-01).

In order to set the message to continuous or duplicate screen, only the first sub-screen is effective.



In one alarm group, the bit memory tables less than continuous 128 can be used and the state of up to 128 contacts can be monitored. The smaller the bit memory table number, the higher the order of priority a message has.

The following settings are done to each bit memory table.

- Recording the alarm history  
Setting of whether or not a change of PC contact to which the bit memory table is assigned is recorded.
- Screen switchover function  
Setting of whether or not the screen switchover function is used.
- Character-string memory table number  
Character-string memory table number displayed as a message is set.
- Display color (NT620C only)  
Character color of a message is set.
- Image library  
Code of image library data displayed together with a message is set.
- Screen switchover  
Screen number displayed by the alarm list and history display function is set.
- Contact  
Contact on the PC, to which the bit memory table is assigned, is set.

Symbol	C Series PCs	Allocated	CVM1/CV Series PCs	Allocated
DM	Data Memory	✓	Data Memory	✓
CH	Internal/Special Relay	✓	Internal/Special Relay	✓
TIM	Timer	×	Timer	×
CNT	Counter	×	Counter	×
HR	Holding Relay	✓	–	
AR	Auxiliary Relay	✓	Auxiliary Relay	×
LR	Link Relay	✓	–	

✓: OK    ×: NG

The Auxiliary Relay area of CVM1/CV series PC is used exclusively for special application in the system, and cannot be used for other application.

When Data Memory (DM) is specified, the bit number (00 to 15) is specified following the channel number.

Example of setting:

No.	Host	#	Table	Dsp Cl	Image & Lib	SwScreen	Bit	Comment
000	No	No					-----	
001	No	No					-----	
002	Ys	No	999	Red	FD20	2000	CH 000000	
003	Ys	No	123	Blue	FD21	1234	AR 000000	
004	No	No	124	Whit	FD22	1235	LR 001003	
005	No	No	125	Whit	FD23	1236	LR 001004	
006	No	No					-----	
007	No	No					-----	

In this example, four contacts of CH000000, AR000000, LR001003, LR001004 are monitored using four bit memory tables of bit memory table numbers 002 to 005.

### 4-11-2 Displaying the Alarm History

Alarm History always monitors the state of contact that has the “Record” setting in the item “Recording the alarm history” of the bit memory table, and records the date and time when the contact turns “1” (ON).

The contacts recorded in the alarm history are always monitored irrespective of the display screen of the NT620S/620C. If the number of contacts are increased excessively, the processing speed of the NT620S/620C may become slower.

Alarm history is common to all bit memory tables. Unlike the message display, it cannot deal with only a part of bit memory table.

#### Recording Format of Alarm History

For the alarm history, the following data is recorded in the memory concerning the contact that turns “1” (ON).

- Contact number
- Date and time of occurrence
- Message set in the bit memory table (the contents of the character-string memory table)

**Maximum Number of Alarms to be Recorded**

The number of alarms to be recorded is up to 256 in the order of occurrence.

Data recorded is backed up by a battery, so it is not lost even when the power supply is turned OFF.

**Reference**

When the voltage of the battery in the NT620S/NT620C drops, the recorded data cannot be retained reliably.

How to deal with alarm recording when the number of alarms capable of being recorded is exceeded is determined by the "Alarm First-in First-out" setting of the "System Memory" of the support tool as follows:

ON: Old history is cleared and new history is recorded.

OFF: Alarms in excess of 256 are not recorded (new alarms are discarded).

In order to clear (initialize) the alarm history, the memory is initialized (Refer to page 70).

**How to Make Sure of Alarm History**

The alarm history can be displayed by the NT620S/620C during operation by setting an area and displaying method when creating a screen data with the support tool.

There are two displaying methods: in the order of occurrence and frequency.

- In the order of occurrence

The alarm history is displayed in the order that a contact becomes "1" (ON). As more detailed information, date and time of occurrence can be displayed simultaneously.

Abnormal remote I/O	94/06/06	16:02	▲
Abnormal high function unit	94/06/07	09:21	▲
Cycle time over	94/06/17	15:44	
			▼
			▼

**Occurrence of transmission abnormality**

Check the remote I/O transmission line!

- In order of frequency

The alarm history is displayed in the order of frequency that a contact becomes "1" (ON). Number of occurrence is displayed simultaneously.

Cycle time over	114	▲
Abnormal high function unit	53	▲
Abnormal remote I/O	39	
		▼
		▼

**Cycle time exceeds 100 msec!**

The following countermeasure should be taken: Program is checked again. Setting of cycle time over not detected (DM6655:X1XX)

For both order of occurrence and order of frequency, the maximum number of entries that can be displayed is 16 in the case of the NT620S and 24 in the case of the NT620C. When the alarm history is set, the scrolling keys are created automatically. Creating and using the scrolling keys are the same as the alarm list display. Refer to the "Scrolling the message" (page 193). Displaying the image library and switching over the screen are the same as the alarm list display. Refer to the "Switching the Image Library to be Displayed" and "Switching over to the Corresponding Screen" (page 194).

The alarm history can be displayed simultaneously in the order of occurrence and frequency in one screen, respectively.

The alarm history display function does not automatically update the contents of display even when the state of contact is changed during displaying operation. The contents of display is updated when pressing the scrolling keys.

---

## SECTION 5

### Using Host Link/NT Link

This section describes how the NT620S/620C can be used when using the Host link/NT link (1:1/1:N).

5-1	Outline of Host Link / NT Link Operation	200
5-1-1	Equipment and Settings Used in This Chapter	200
5-1-2	Allocatable Bits and Words	200
5-1-3	NT620S/620C Status Control and Notification to PC	201
5-1-4	Switching the Screen Display (by Using the PT Status Control Area)	207
5-1-5	Switching the Screen Display (by Using the Allocated Bit of a Bit Memory Table)	210
5-1-6	Notifying the Display Screen to the PC (To Display the Number of Currently Displayed Screen)	212
5-2	Memory Tables and Graphs	215
5-2-1	Allocation Words and Display of the Memory Tables	219
5-2-2	Changing Displayed Numerals or Character Strings (Changing the Contents of Allocated Words....Direct Specification)	221
5-2-3	Changing Displayed Numerals or Character-Strings (Changing the Contents of Allocated Words ..... Indirect Specification)	223
5-2-4	Copying the Memory Table	226
5-2-5	Upgrading Graphs (Changing the Contents of Allocated Words)	230
5-3	Lamps and Touch Switches	231
5-3-1	Allocation Bits and Display of Lamps	231
5-3-2	Turning ON (lit) and OFF (unlit) the Lamps (Changing the Contents of Allocated Bits)	232
5-3-3	Allocated Bits, and Display, of Touch Switches	234
5-3-4	Lit (Flashing) and Unlit Touch Switch Statuses (Changing the Status of Allocated Bits)	236
5-3-5	Notifying the PC that a Switch has been Pressed (Determining Touch Switch Status)	237
5-4	Numeral and Character-string Setting	241
5-4-1	Notification of Numbers to the PC	241
5-4-2	Notification of Character-string to the PC	244
5-5	Alarm Lists	247
5-5-1	Allocated Bits of Bit Memory Tables	247
5-5-2	Displaying Alarm Lists (by Using Bit Memory Table Allocation)	247
5-6	Clock Function	251
5-6-1	About the Clock Function	251
5-6-2	Date and Time Display	252
5-6-3	Date and Time Setting	252
5-6-4	Notification of the Date and Time to the PC	255
5-7	NT620S/620C Status Control	257
5-7-1	Controllable NT620S/620C Functions	257
5-7-2	How to Control NT620S/620C Functions	261
5-8	Notification of the Operating Status to the PC (Determining the NT620S/620C Operating Status)	263
5-8-1	Ascertainable NT620S/620C Statuses (Notified Operating Statuses)	263
5-8-2	Reading the NT620S/620C Operating Statuses	264

## 5-1 Outline of Host Link / NT Link Operation

This section explains the fundamentals when using the host link/NT link - allocated bits and words, and the method for control of the NT620S/620C and notification to the PC, and also describes the actual procedure used for screen switching.

### 5-1-1 Equipment and Settings Used in This Chapter

The following equipment and settings are used in the examples in this Chapter:

[Equipment] PT : NT620S-ST211

PC : CQM1

Support tool : NT-series Support Tool Ver. 2.□

[Support tool settings]

PT : 610G (Note: This is not "620S".)

Memory capacity : 512 KB

Direct connection : Ver.4

### 5-1-2 Allocatable Bits and Words

The following bits and words are allocated to the PC and used for the NT620S/620C operation. The range of respective area varies with the type of PC. Refer to Appendix L "PC Memory Map" (page 354).

The allocations must be made without exceeding respective area range.

[OMRON PCs]

Symbol	C Series PCs				CVM1/CV Series PCs			
	Area Name	Allocated Bit	Allocated Word		Area Name	Allocated Bit	Allocated Word	
			Numeral	Character String			Numeral	Character String
DM	Data Memory	✓	✓	✓	Data Memory	✓	✓	✓
CH	Internal/Special Relay	✓	✓	✓	Internal/Special Relay	✓	✓	✓
TIM	Timer	×	△	×	Timer	×	△	×
CNT	Counter	×	△	×	Counter	×	△	×
HR	Holding Relay	✓	✓	✓	-			
AR	Auxiliary Relay	✓	✓	✓	Auxiliary Relay	✓	✓	×
LR	Link Relay	✓	✓	✓	-			

✓ : OK   △ : 1 word only   × : NG

When allocating a memory table to words, the allocation must not exceed the word area.

Since the special auxiliary relays of the CV series PCs are allocated to the system, they cannot be used for purposes other than the system use. However, reading from them is possible.

One allocation word of the memory table can use continuous areas of up to 2 words in the case of numeral memory table or 20 words in the case of character-string memory table.

### 5-1-3 NT620S/620C Status Control and Notification to PC

This section describes the fundamentals of the display elements, NT620S/620C status control, and notification which are the basics of the NT620S/620C functions.

For the detail method of use of the PT status control area and the PT status notify area, refer to Sections 5-7 "NT620S/620C Status Control" (page 257) and 5-8 "Notification of the Operating Status to the PC" (page 263).

#### Controlling the Display Elements by Using Allocated Bits and Words

The NT620S/620C will operate as follows in the display element control operation.

##### [NT620S/620C operation]

- (1) The NT620S/620C checks the allocation bits and words of the display elements and makes an inquiry to the PC.
- (2) The PC answers the NT620S/620C about the bit and word data.
- (3) The NT620S/620C changes the display status according to the bits and words obtained from the PC.

##### [NT620S/620C operation example]

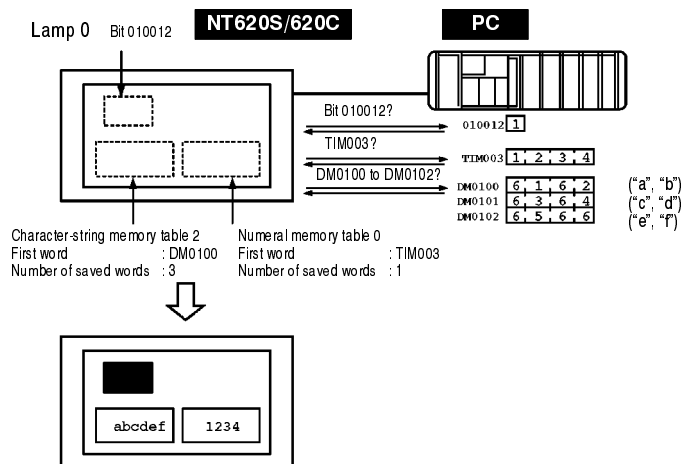

**Controlling the NT620S/620C Status by Using Allocated Bits and Words**

**..... PT Status Control Area (PC to PT)**

The PT status control area (PC to PT) is provided to control the NT620S/620C status from the PC. When data is written to this area in the PC, the NT620S/620C will read the data and operates according to the data. The PT status control area is configured as four consecutive words as shown below.

Word	15	14	13	12	11	10	9	8	7	6	5	4	3	2	1	0	Bit				
n	Screen No. (4-digit BCD)											Screen switch setting									
n+1	0		Copy source memory table No. (3-digit BCD)											Copy memory table setting							
n+2	Copy type		Copy destination memory table No. (3-digit BCD)																		
n+3	PT status control bit											0	0	0	0	0	PT status control				

The first word (word n) of the PT status control area must be set with the support tool.

- Screen switch settings (refer to page 207)  
Specify the screen No. to switch the screen displayed on the NT620S/620C.
- Copy memory table settings (refer to page 226)  
Specify the memory table No. to copy the contents of a memory table internally in the NT620S/620C.  
Set the copy type to match the type of memory table to be copied:  
0: Character-string memory table  
1: Numeral table



- PT status control bits (refer to page 257)

Set the bits ON or OFF according to the following table to control the screen display and buzzer.

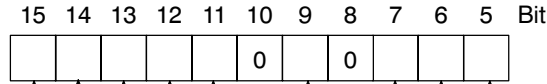

Controlled Item	1 (ON)	0 (OFF)
Screen display	Performed	Not performed
Processing priority registration (See Note)	Registered	Canceled
Continuous buzzer	Sounded	Not sounded
Intermittent buzzer (short)	Sounded	Not sounded
Display history initialization	Performed	Not performed
Intermittent buzzer (long)	Sounded	Not sounded
Screen printing	Performed	Not performed
Window opening	Disabled	Enabled
Numeral/character-string input	Disabled	Enabled

Note: Priority registration is only effective when NT link (1:N) is set.

The PT status control area (PC to PT) can be allocated to the following PC areas.

Symbol	C Series PCs	Allocated	CVM1/CV Series PCs	Allocated
DM	Data memory	✓	Data memory	✓
CH	Internal/Special Relay	✓	Internal/Special Relay	✓
TIM	Timer	×	Timer	×
CNT	Counter	×	Counter	×
HR	Holding Relay	✓	-	
AR	Auxiliary Relay	✓	Auxiliary Relay	×
LR	Link Relay	✓	-	

✓: OK    ×: NG

Since the auxiliary relays of the CV series PCs are allocated to the system, they cannot be used for purposes other than the system use.

The range of each memory area differs according to the PC type. See Appendix L "PC Memory Map" (page 354).

**Note** Make the allocations so that there is no duplication between the PT status control area and the PT status notify area.

**Notifying the Display Elements by Using Allocated Bits and Words**

The NT620S/620C will operate as follows in the display element notification operation.

**[NT620S/620C operation]**

The NT620S/620C will write any changes in the contents of the numeral or character-string memory table being displayed or pressing of a touch switch to the bits and words area in the PC.

**[NT620S/620C operation example]**

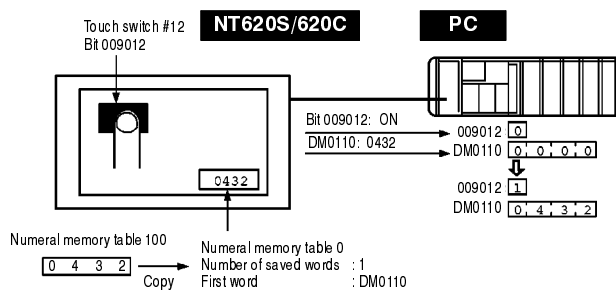

**Notifying the NT620S/620C Status by Using Allocated Bits and Words ..... PT Status Notify Area (PT to PC)**

The PT status notify area (PT to PC) is provided to notify the NT620S/620C status changes to the PC. When any NT620S/620C status has changed, such change is written to this area in the PC, and the PC will read the data from this area to check the NT620S/620C status.

The PT status notify area is configured as three consecutive words as shown below.

Word	15	14	13	12	11	10	9	8	7	6	5	4	3	2	1	0	Bit	
m	Screen No. (4-digit BCD)															Screen being displayed		
m+1	0															Content upgrade memory table		
m+2	PT status															PT status		

The first word (word m) of the PT status notify area must be set with the support tool.

- Currently displayed screen (refer to page 212)

The screen number displayed on the NT620S/620C is written to this word.

Simultaneously, the PT status screen switch strobe flag is set to ON (1). After this is notified to the PC, this flag reverts to OFF (0). Checking the status of this flag will provide a simple method of checking if the NT620S/620C display has switched.

- Content upgrade memory table (refer to page 242)

The number of the numeral or character-string table is written to the word when the numeral or character-string memory table contents change due to the touch switch operation on the NT620S/620C. (The contents of the word to which the numeral or character-string table has been allocated also change.)

As the number of the numeral table is written, the PT status numeral or character-string setting strobe flag is simultaneously set ON (1). After this is notified to the PC, this flag reverts to OFF (0). Checking the status of this flag will provide a simple method of checking if a number or character-string has been input from the NT620S/620C.

- PT status notify bits (refer to page 263)

The NT620S/620C operation status and other information are written with the ON or OFF of the bits as shown below.

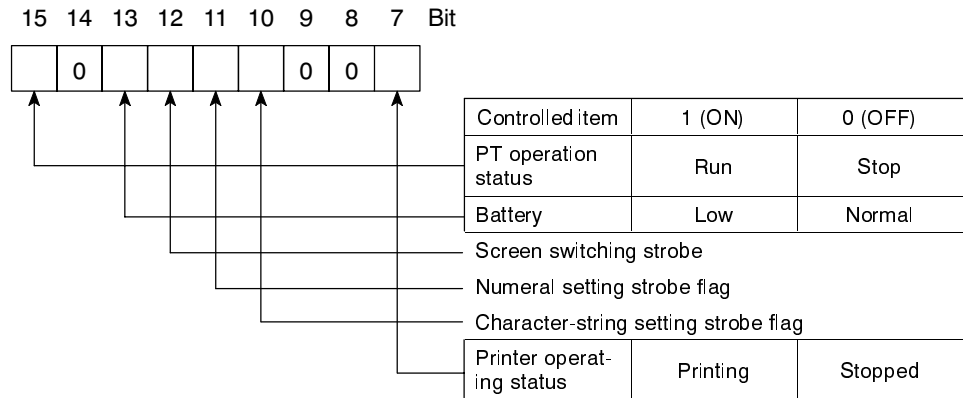

The PT status control area (PC to PT) can be allocated to the following PC areas.

Symbol	C Series PCs	Allocated	CVM1/CV Series PCs	Allocated
DM	Data Memory	✓	Data Memory	✓
CH	Internal/Special Relay	✓	Internal/Special Relay	✓
TIM	Timer	×	Timer	×
CNT	Counter	×	Counter	×
HR	Holding Relay	✓	-	
AR	Auxiliary Relay	✓	Auxiliary Relay	×
LR	Link Relay	✓	-	

✓: OK    ×: NG

Since the special auxiliary relays of the CVM1/CV series PCs are allocated to the system, they cannot be used for purposes other than the system use.

The range of respective area varies with the type of PC. Refer to Appendix L “PC Memory Map” (page 354).

**Reference**

- Make the allocations so that there is no duplication between the PT status control area and the PT status notify area.
- When using the NT link (1:N), allocate a PT status control area for each of the connected PTs.

### 5-1-4 Switching the Screen Display (by Using the PT Status Control Area)

The following describes the procedure used to switch the NT620S/620C screen display by controlling from the PC by the PT status control area.

The displayed screen can also be switched by other methods: by registering a screen number for a touch switch or bit memory table and then pressing the touch switch, or by changing the status of the allocated bit of a bit memory table, during operation. For details on these methods, see “Stand Alone Functions” (page 165) or the next section, “Switching the Screen Display (by Using the Allocated Bit of a Bit Memory Table)”.

To switch the NT620S/620C screen display by controlling from the PC, write a screen number at the “screen switch setting” in the PT status control area.

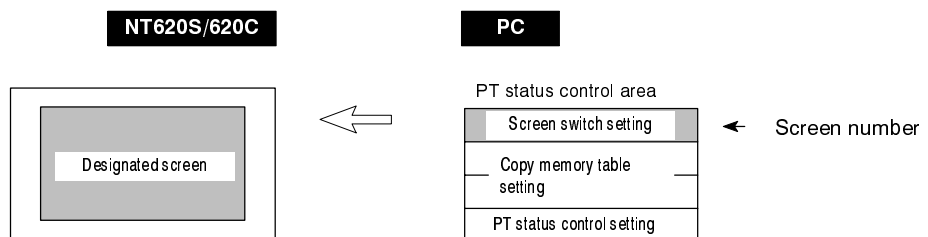

#### [Screen switch setting in the PT status control area]

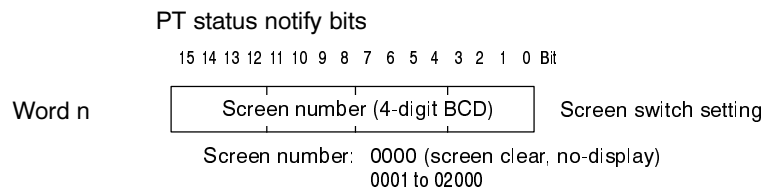

#### Reference

The screens numbered 1997 to 1999 are earmarked for special functions, as shown below. The display history can be checked by calling them during operation.

- 1997 : Display history (order of occurrence) screen
- 1998 : Display history (order of frequency) screen
- 1999 : Screen when connected to the host

- Available allocation words

The PT status control area (PC to PT) can be allocated to the following PC areas.

Symbol	C Series PCs	Allocated	CVM1/CV Series PCs	Allocated
DM	Data Memory	✓	Data Memory	✓
CH	Internal/Special Relay	✓	Internal/Special Relay	✓
TIM	Timer	×	Timer	×
CNT	Counter	×	Counter	×
HR	Holding Relay	✓	–	
AR	Auxiliary Relay	✓	Auxiliary Relay	×
LR	Link Relay	✓	–	

✓: OK    ×: NG

Since the special auxiliary relays of the CVM1/CV series PCs are allocated to the system, they cannot be used for purposes other than the system use.

The range of respective area varies with the type of PC. Refer to Appendix L “PC Memory Map” (page 354).

- Procedure**
1. Use the support tool to allocate the PT status control area (PC to PT) to the PC memory.
  2. Create a PC program to write the number of the displayed screen to the “screen switch setting word” in the PT status control area.

Use a 4-digit BCD (binary-coded decimal) value to set a screen number.

If a screen has been switched by operating the PT status control area (PC to PT), the contents of the “currently displayed screen word” in the PT status notify area (PT to PC) also change.

- Startup screen

When the NT620S/620C starts up, it displays the screen whose screen number is written in the “screen switch setting”. The startup screen set with the support tool is invalid.

- Screen switching timing

The NT620S/620C screen switches when the contents of the “screen switch setting” have changed. To re-specify the number of the currently specified screen, first write the value 0000 to clear the screen before writing the appropriate screen number.

- Use of the screen switching strobe

Create a program to read the number of the currently displayed screen and to write the number to the “screen switch setting word” at the leading edge of the “screen switching strobe” of the PT status notify area. This program enables screen switching by using the touch switches on the NT620S/620C and eliminates repeated setting of the same screen number. If the screen switching is not executed on the NT620S/620C, the screen switching strobe does not need to be checked.

For the screen switching strobe, refer to the “notifying the displayed screen to the PC” (page 212).

- Continuous screens and overlapping screens

Continuous or overlapping screens can be displayed by designating the parent screen. If a child screen is designated, only the child screen is displayed.

For the continuous and overlapping screens, refer to the “Classification of screens” (page 135).

**Example of Display Screen Switching**

This example operates the PC switch (bit) to switch the NT620S/620C display screen.

- Support tool settings

Make the following settings with the support tool:

PT status control area: CH 0100

PT status notify area: CH 0110

Screen number to be created: Screen No. 2 and No. 3

- PC ladder program

Create a PC ladder program as follows:

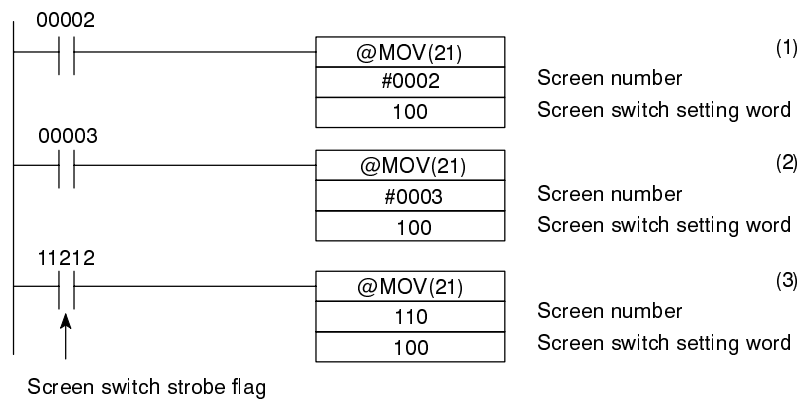

- Program operation

- (1) Screen No. 2 is displayed on the NT620S/620C when bit 00002 turns ON.
- (2) Screen No. 3 is displayed on the NT620S/620C when bit 00003 turns ON.
- (3) When the screen switch strobe flag turns ON, the number of the currently displayed screen is read and written to the currently displayed screen word in the PT status notify area. In this case, the NT620S/620C will not write the same screen twice.

### 5-1-5 Switching the Screen Display (by Using the Allocated Bit of a Bit Memory Table)

This section describes the actual procedure used to perform screen switching under the control of the PC by using bit memory tables.

This function continually reads the allocated bits of the screen switching function regardless of which screen is currently displayed. Consequently, if the number of screens that could be switched to with this function is large, PT operations (such as updating of memory tables, touch switch response, lamp response) may be delayed.

One of two methods can be used to switch the screen display: registering a screen number for a touch switch and pressing the touch switch during operation, or writing the screen number into the PT status control area. For details on these methods, see “Stand Alone Functions” (page 165) or “Switching the Screen Display (by Using the PT Status Control Area)” (page 207).

To switch the screen displayed on the screen of the NT620S/620C under the control of the PC, the allocated bit of the bit memory table in which the screen number of the screen to be displayed is registered is set to “1” (ON).

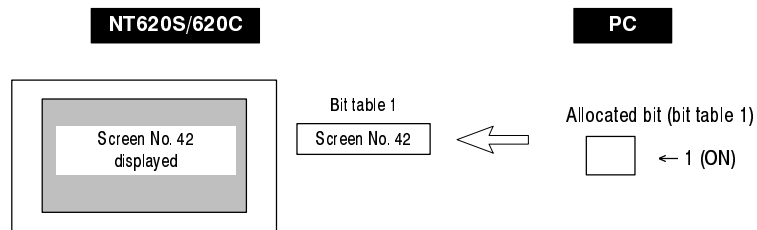

**Reference**

The screens numbered 1997 to 1999 are earmarked for special functions, as shown below. The display history can be checked by calling them during operation.

- 1997 : Display history (order of occurrence) screen
- 1998 : Display history (order of frequency) screen
- 1999 : Screen when connected to the host

• Available allocation bits

Bit memory tables can be allocated to the following areas of the PC.

Symbol	C Series PCs	Allocated	CVM1/CV Series PCs	Allocated
DM	Data Memory	✓	Data Memory	✓
CH	Internal/Special Relay	✓	Internal/Special Relay	✓
TIM	Timer	×	Timer	×
CNT	Counter	×	Counter	×
HR	Holding Relay	✓	-	
AR	Auxiliary Relay	✓	Auxiliary Relay	×
LR	Link Relay	✓	-	

✓ : OK    × : NG



Since the special auxiliary relays of the CV series PCs are allocated to the system, they cannot be used for purposes other than system use.

The range of respective area varies with the type of PC. Refer to Appendix L "PC Memory Map" (page 354).

- Procedure**
1. Use the support tool to set the following for the following for a bit memory table: a screen switching function, the screen number of the screen to be displayed, and the area of the PC to which the bit is to be allocated.
  2. At the PC, write the program that will switch the allocated bit from OFF to ON and switch the screen display.  
In cases such as that where a warning screen is to be displayed when a particular bit is turned ON, there is no need to write a program; it is sufficient just to set the allocated bit.

- Screen display timing

The NT620S/620C screen switches when the allocated bit of the bit memory table changes from the "0" (OFF) to "1" (ON) status. However, the display does not change when the allocated bit returns from the "1" (ON) to the "0" (OFF) status.

**Example Application of Screen Switching**

In this example, if the temperature in a water tank rises above the upper limit, a bit is turned ON, and the warning screen that corresponds to the bit is displayed.

- Support tool settings

The following settings are made using the support tool.

Bit memory table No. 0

Allocated bit . . . . . CH 000100 (input bit that comes ON when the temperature of the water tank rises above the upper limit)

Function . . . . . Screen switching (screen No. 1000)

Created screen No. . . . Screen No. 1000

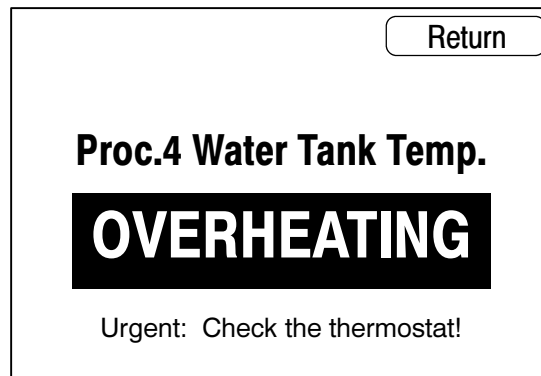

- PC program

A ladder program to control the NT620S/620C is not required.

- Program operation

When bit 001000 comes ON, the NT620S/620C displays screen No. 1000.

### 5-1-6 Notifying the Display Screen to the PC (To Know the Number of Currently Displayed Screen)

The following describes the processing to know the number of currently displayed screen of the NT620S/620C.

This processing reads the data from the PC status notify area.

To indicate that the screen has switched, use the screen switch strobe flag.

To display the number of the currently displayed screen, use the currently displayed screen word.

When the screen has switched, the NT620S/620C notifies the following to PT status notify area (PT to PC) allocated to the PC.

Screen switch notification: Screen switch strobe flag of the PT status word

New screen number: Currently displayed screen word

By reading the currently displayed screen word when the screen switch strobe flag has turned ON, the number of the currently displayed screen on the NT620S/620C is displayed.

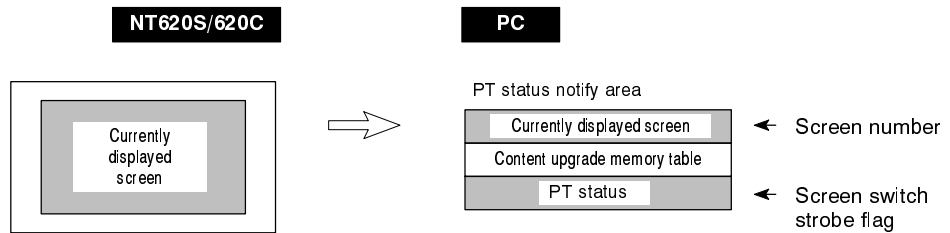

#### [Currently displayed screen] and [PT status] words in the PT status notify area

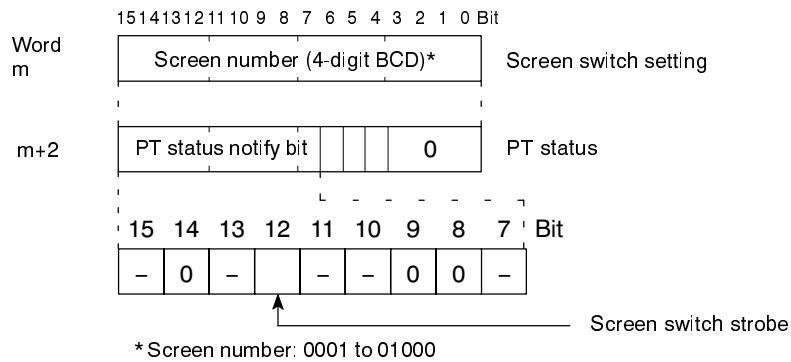

Use a 4-digit BCD (binary-coded decimal) value to set a screen number.

The screen switch strobe bit reverts to OFF (0) after this is notified to the PC.

- Available allocation words

The PT status notify area (PT to PC) can be allocated to the following PC areas.

Symbol	C Series PCs	Allocated	CVM1/CV Series PCs	Allocated
DM	Data memory	✓	Data memory	✓
CH	Internal/Special Relay	✓	Internal/Special Relay	✓
TIM	Timer	×	Timer	×
CNT	Counter	×	Counter	×
HR	Holding Relay	✓	–	
AR	Auxiliary Relay	✓	Auxiliary Relay	×
LR	Link Relay	✓	–	

✓ : OK    × : NG

Since the special auxiliary relays of the CV series PCs are allocated to the system, they cannot be used for purposes other than the system use.

The range of respective area varies with the type of PC. Refer to Appendix L “PC Memory Map” (page 354).

- Procedure**
1. Use the support tool to allocate the PT status notify area (PT to PC) to the PC memory.
  2. Create a PC program to read the “currently displayed screen word” in the PT status notify area when the “screen switch strobe flag” in the PT status notify area has turned ON.

The contents of the “currently displayed screen word” are updated also by switching the screen by pressing a touch switch on the NT620S/620C.

For this function, refer to the “Stand Alone Function” (page 165) or “Switching the Screen Display (by Using the Allocated Bit of a Bit Memory Table)” (page 210).

- Continuous screens and overlapping screens

When a continuous or overlapping screen is displayed, the number of the parent screen is written to the “currently displayed screen word”.

For the continuous and overlapping screens, refer to the “Classification of screens” (page 135).

### Example of Reading the Number of Currently Display Screen

This example gives a PC program that reads the screen number each time the screen is switched. In this example, the number of the previous screen is also stored.

- Support tool settings

Make the following settings with the support tool:

PT status notify area: CH 0110

- PC ladder program

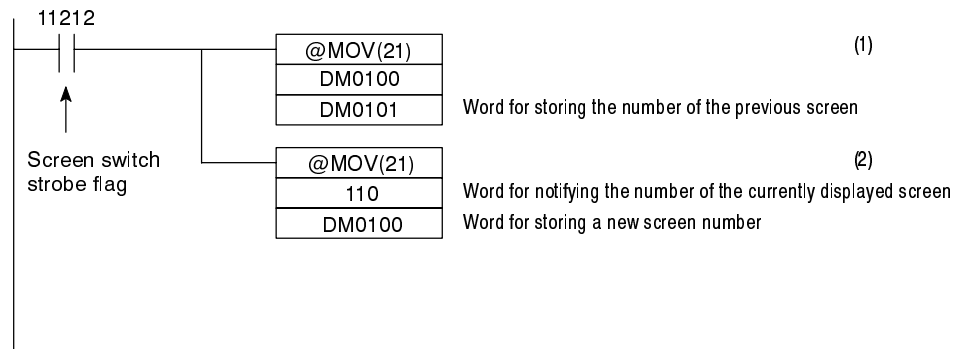

- Program operation

- (1) When the NT620S/620C screen display switches and the screen switch strobe flag (bit 11212) turns ON, the contents of DM0100 are transferred to DM0101. The number of the previously displayed screen is stored in word 0101.
- (2) The new screen number notified by the NT620S/620C is read and transferred to DM0100. The number of the currently displayed screen is stored in DM0100.

## 5-2 Memory Tables and Graphs

### Displaying and Referencing Character-String Memory Table Contents

Since character-string memory tables can be allocated to words in the PC, the PC can write data to the character-string memory tables, and initial values can be set when creating the screen data.

During operation, automatic updating is performed to ensure that the currently displayed NT620S/620C character-string memory table contents and PC word contents always match each other.

There are two methods for referencing character-string memory tables used for character-string display, as follows:

- Direct specification
- Indirect specification

#### Reference

Only direct specification can be used as the reference method for character-string memory tables used for character-string settings.

- Direct specification

Direct specification is a method of specification in which the contents of displayed memory tables are directly correlated with the contents of the allocated words.

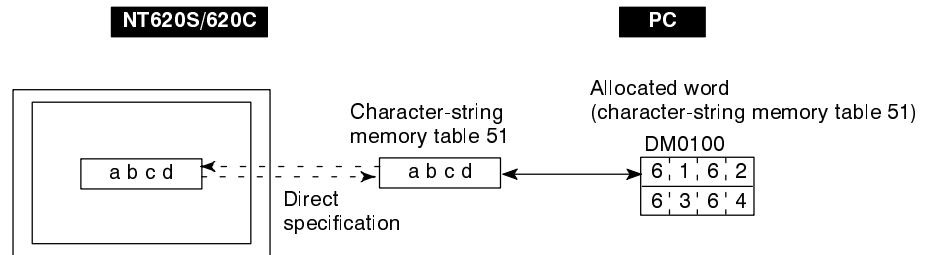

- Indirect specification

In indirect specification, even if the displayed data is a character-string, the display is correlated with a numeral memory table. The contents (numerical value) of this numeral memory table are regarded as a character-string memory table number and the contents of the table with this number are displayed.

A combined total 50 of numeral displays and character-string displays can be specified on one screen by using indirect specification.

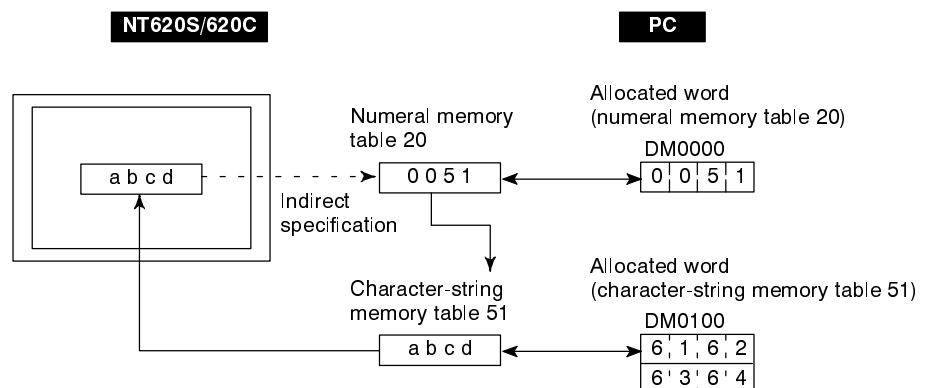

This specification method is a little complex, but it allows the display to be changed more easily according to the circumstances. In the example above, if 1 were added to the contents of memory table 20 to give 52, the contents of memory table 52 would be displayed instead.

The memory tables used for display can also be allocated to areas in the PC, so that the display can also be changed in response to changes in the data to be displayed (i.e., the contents of character-string memory table 51 in the example above).

However, in comparison with direct specification, indirect specification requires more time for processing.

### Setting the Words of the Character-String Memory Table

When creating the screen data by using the support tool, make the following settings for each numbered character-string:

- Initialization setting

Set whether or not the PC words are initialized with the character-string memory table initial value registered to the screen data memory when the main power supply is turned ON or reset.

- Number of registration words

Set the number of words within 20 words required for registering the character-string data. One word can store two characters.

- Setting the words for the character-string memory tables

The character-string memory tables can be allocated to the following PC words. Set the word type and the first word.

Symbol	C Series PCs	Allocated	CVM1/CV Series PCs	Allocated
DM	Data memory	✓	Data memory	✓
CH	Internal/Special Relay	✓	Internal/Special Relay	✓
TIM	Timer	×	Timer	×
CNT	Counter	×	Counter	×
HR	Holding Relay	✓	–	
AR	Auxiliary Relay	✓	Auxiliary Relay	×
LR	Link Relay	✓	–	

✓: OK    ×: NG

Since the special auxiliary relays of the CVM1/CV series PCs are allocated to the system, they cannot be used for purposes other than the system use.

The range of respective area varies with the type of PC. Refer to Appendix L “PC Memory Map” (page 354).

If the “number of registration words x 2” (“word setting window”) set with the support tool is larger than the “number of character digits” (“character-string display setting” window), the character-string may be broken halfway.

**Displaying and Referencing Numeral Memory Table Contents**

Since numeral memory tables can be allocated to words in the PC, the PC can write data to the numeral memory tables, and initial values can be set when creating the screen data.

In addition, if a numeral memory table is correlated with a graph, the graph can be displayed in accordance with the numeric value in the numeral memory table.

During operation, automatic updating is performed to ensure that the currently displayed NT620S/620C numeral memory table contents and PC word contents always match each other.

There are two methods for referencing numeral memory tables used for numeral display, as follows:

- Direct specification
- Indirect specification

Only direct specification can be used as the reference method for graphs and numeral settings.

- Direct specification

Direct specification is a method of specification in which the contents of displayed memory tables are directly correlated with the contents of the allocated words.

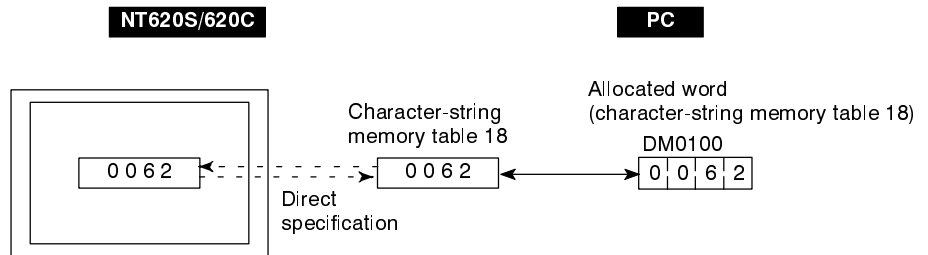

- Indirect specification

Indirect specification is a method whereby the contents (numeric value) of the specified numeral memory table are taken as the number of a numeral memory table, and the contents of the numeral memory table with that number are displayed.

A combined total 50 of numeral displays and character-string displays can be specified on one screen by using indirect specification.

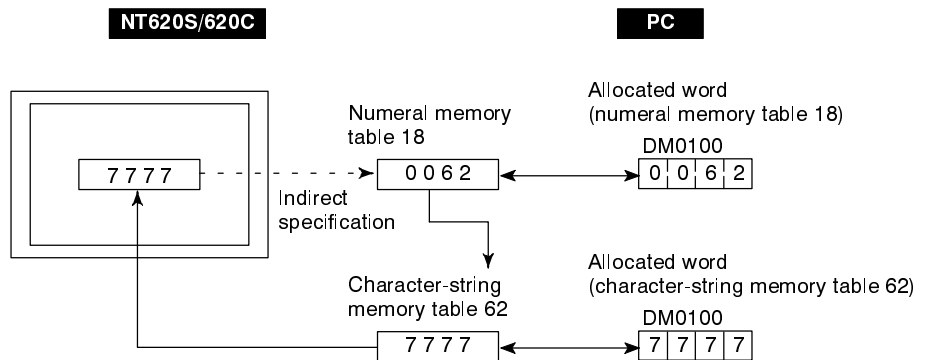

This specification method is a little complex, but it allows the display to be changed more easily according to the circumstances. In the example above, if 1 were added to the contents of memory table 18 to give 52, the contents of memory table 63 would be displayed instead.

The memory tables used for display can also be allocated to areas in the PC, so that the display can also be changed in response to changes in the data to be displayed (i.e., the contents of character-string memory table 62 in the example above).

However, in comparison with direct specification, indirect specification requires more time for processing.

### Setting the Words of the Numeral Memory Table

When creating the screen data by using the support tool, make the following settings for each numbered numeral:

- Initialization setting

Set whether or not the PC words are initialized with the numeral memory table initial value registered to the screen data memory when the main power supply is turned ON or reset.

- Number of registration words

Set the number of words within 2 words required for registering the numeral data. One word can store up to 4 digits. Two words can store up to 8 digits.

- Setting the words for the numeral memory tables

The numeral memory tables can be allocated to the following PC words. Set the word type and the first word.

Symbol	C Series PCs	Allocated	CVM1/CV Series PCs	Allocated
DM	Data Memory	✓	Data Memory	✓
CH	Internal/Special relay	✓	Internal/Special relay	✓
TIM	Timer	△	Timer	△
CNT	Counter	△	Counter	△
HR	Holding Relay	✓	–	
AR	Auxiliary Relay	✓	Auxiliary Relay	×
LR	Link Relay	✓	–	

✓: OK    △: 1 word only    ×: NG

Since the special auxiliary relays of the CVM1/CV series PCs are allocated to the system, they cannot be used for purposes other than the system use.

The range of respective area varies with the type of PC. Refer to Appendix L “PC Memory Map” (page 354).



## 5-2-1 Allocation Words and Display of the Memory Tables

This section explains the relationship between the contents of the allocated words of numeral/character-string memory tables and their display.

- Contents of numeral memory tables

### [Stored as a single word]

15	to	12	11	to	8	7	to	4	3	to	0	Bit			
Digit 4				Digit 3				Digit 2				Digit 1			

Example: 1234

15	to	12	11	to	8	7	to	4	3	to	0	Bit			
1				2				3				4			

### [Stored as a double words]

Word	15	to	12	11	to	8	7	to	4	3	to	0	Bit			
Start	Digit 4				Digit 3				Digit 2				Digit 1			
Start+ 1	Digit 8				Digit 7				Digit 6				Digit 5			

Example: 12345678

Word	15	to	12	11	to	8	7	to	4	3	to	0	Bit			
Start	5				6				7				8			
Start+ 1	1				2				3				4			

- Displaying the numeral memory table

Numerals can be displayed in three different ways according to the contents of the numeral memory table, as mentioned below.

The most significant digit (digit 4 of a single word or digit 8 of a double word) is processed in different ways.

Hexadecimal display: All digits are handled as stored in the allocated words.

Decimal display without signs: If the most significant digit is "F", it is handled as "0", and the most significant digit other than "F" and other digits are handled as stored in the allocated words.

Decimal display with signs: If the most significant digit is "F", it is handled as "-" (minus sign), and the most significant digit other than "F" and other digits are handled as stored in the allocated words.

**[Numeral memory table display examples]**

- When the data are numeral data (0 to 9)

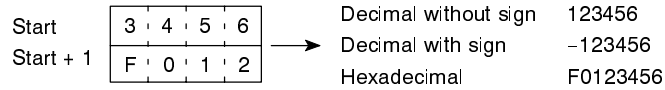

- When the data contain characters (A to F)

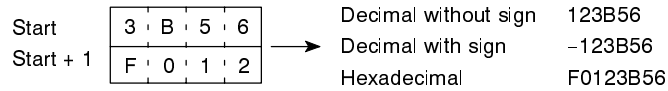

If the hexadecimal data (A to F) are stored when the decimal display has been set, the alphabets are displayed.

If the number of display digits has been set to be smaller than the maximum number of digits of the registration words (4 digits for 1 word; 8 digits for 2 words), the contents of the allocated words are not displayed and “\*” symbols will be displayed at all digits.

If the most significant digit is “F” when “decimal with signs” has been set, the numeral is handled as a negative number. The maximum number of digits of the negative number becomes smaller than that of the positive number by 1 digit.

The actual display will vary according to the “zero suppress” setting and decimal fraction setting as well as the contents mentioned above. Refer to the “NT-series Support Tool Operation Manual” (V028-E1-02).

• Contents of the character-string memory table

A character-string is stored in the allocated words beginning with the first word in half-size or normal-size characters.

Two half-size characters or two normal-size character is stored in one word. One memory table can store up to 20 words (40 characters).

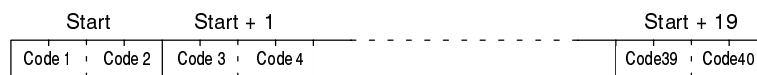

**[Character-string memory table display example]**

To display the characters in order, allocate the characters as follows.

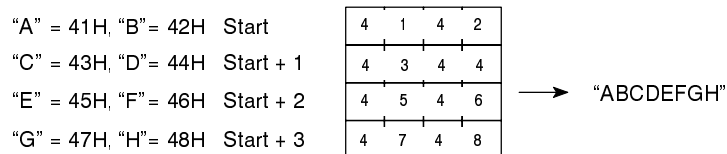

### 5-2-2 Changing Displayed Numerals or Character Strings (Changing the Contents of Allocated Words...Direct Specification)

The following describes the procedure to change displayed numerals or character-strings by changing the contents of the allocated words.

If using indirect specification, refer to “Changing Displayed Numerals or Character-Strings (Changing the Contents of Allocated Words ... Indirect Specification)” (page 223).

Numerals and character-strings can also be changed by copying between memory tables: see “Copying the Memory Table” (page 226).

To change the numerals or character-strings displayed on the NT620S/620C, make changes with the numeral or character-string memory table. To make changes with the numeral or character-string memory table of the NT620S/620C, change the contents of words by the PC.

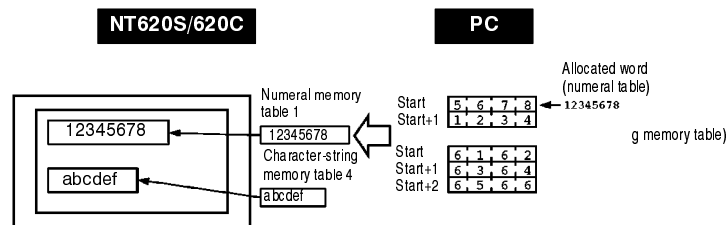

When it is necessary to display changing data such as monitored data of words in the PC, use the numeral and character-string memory tables.

- Procedure**
1. Use the support tool to allocate the numeral and character-string memory tables to the PC memory.

2. Register the memory tables for the numerals and character-strings to be displayed when creating the screen data by using the support tool.

To display a character-string, use “character display” and specify the character-string memory table by using the support tool.

To display numerals, use “numeral display” and specify the numeral memory table by using the support tool.

3. Create a PC program to write the contents of numerals and character-strings to be displayed on the NT620S/620C to the PC words.

- Important points when writing a character-string

If a character-string to be written is smaller than “allocated word x 2”, fill up the vacant space with normal-size spaces (20H). If unnecessary characters are left in the area, the character-string will not be displayed correctly.

**Application Example of the Numeral Memory Tables Allocated to the PC Words**

This example gives the procedure to directly display the contents of the words allocated as the numeral memory tables in the PC memory. The NT620S/620C screen display will change as the contents of the PC word change.

- Support tool settings

Allocate the memory as shown below by using the support tool.

Numeral memory table entry No. 1: DM0000 (registration word: 2)

Numeral memory table entry No. 2: DM0002 (registration word: 1)

Screen numbers to be created: No. 1 and No. 2

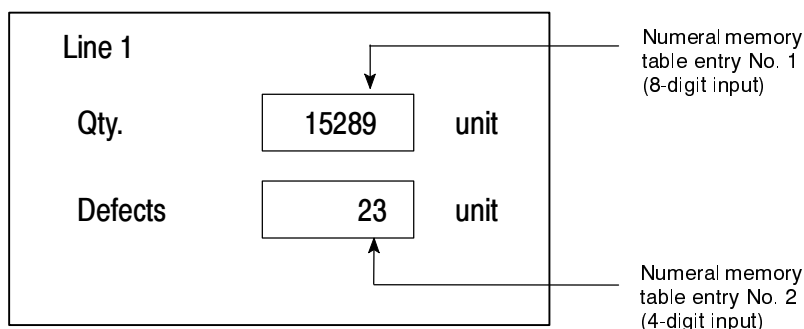

- PC ladder program

Create a PC ladder program as follows:

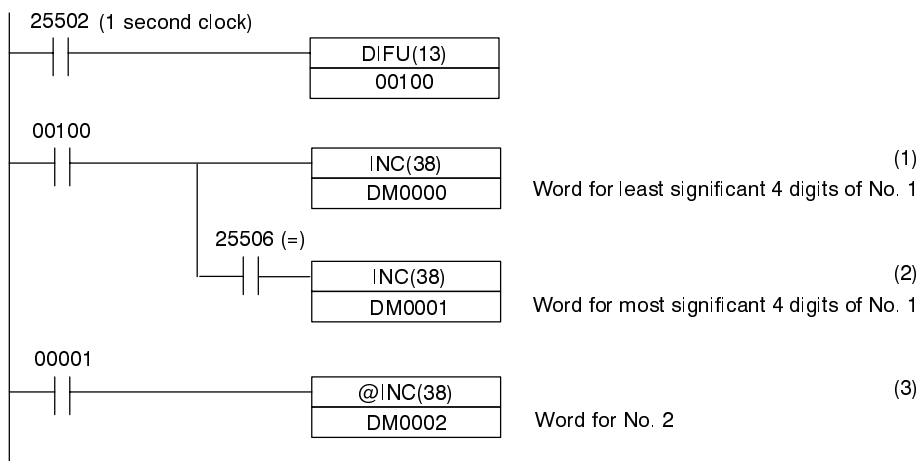

- Program operation

- (1) The contents of word DM0000 are incremented by 1 each second. The value displayed on the NT620S/620C in numeral table entry No. 1 increases by 1 each second.
- (2) When the counter in (1) above causes an increase in the most significant digits, the contents of word DM0001 are incremented by 1 each second. The value displayed on the NT620S/620C in numeral memory table entry No. 1 most significant digits increases by 1.
- (3) When bit 00001 turns ON, the contents of DM0002 are incremented by 1. The value displayed on the NT620S/620C in numeral memory table entry No. 2 increases by 1.

### 5-2-3 Changing Displayed Numerals or Character-Strings (Changing the Contents of Allocated Words .... Indirect Specification)

The following describes the procedure to change displayed numerals or character-strings indirectly by specifying a numeral memory table. The contents of the specified numeral memory table (39 in the following example case) is regarded as the memory table number used for display.

If using direct specification, refer to “Changing Displayed Numerals or Character-Strings (Changing the Contents of Allocated Words ... Direct Specification)” (page 221).

Numerals and character-strings can also be changed by copying between memory tables: see “Copying the Memory Table” (page 226).

Either of the following two methods can be used to change the contents of the display.

- (1) Changing the memory table number to be displayed  
(To change the contents of numeral memory table 41, in the following example case)
- (2) Changing the contents of the memory table used for display  
(To change the contents of character-string memory table 39, in the following example case)

In this section, the procedure for changing the display contents by using method (1) is explained.

Method (2) involves changing the contents of the allocated table. For details, refer to the sections on memory table copy (page 226) and changing displayed numerals or character-strings (direct specification) (page 221).

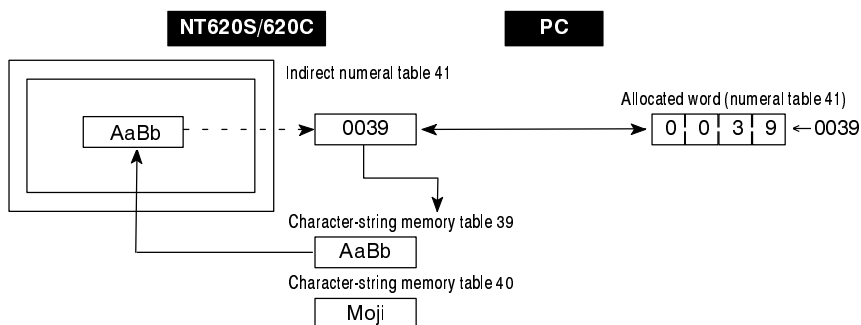

This method is convenient when switching the display at the same location, for example when monitoring a series of words, or when using unique codes to specify individual character strings, etc.

**Procedure** 1. Set the PC area for the numeral memory table to be used for indirect specification of numeral/character display using the support tool.

2. When creating the screen data with the support tool, register for the screen the numeral memory table referenced in indirect specification. Set “Indrct” for “Ref way”.

For a character-string, specify the numeral memory table by using the “character display” function of the support tool.

For numerical values, specify the numeral memory table by using the “numeral display” function of the support tool.

3. Using the “table edit” function of the support tool, write the data to be displayed to the memory table which is used for display. Use a numeral memory table to display numerals and use a character-string memory table to display character-strings.

4. Create a PC program to change the contents of the word allocated to the numeral memory table which is used in indirect specification.

- Important points when writing memory table numbers

When writing the number of the memory table whose contents are to be displayed to the numeral memory table to be referenced in indirect specification, always specify this number in BCD format. Also make sure that you do not specify a number outside the range of memory table numbers that actually exist (for example by specifying “0500” when the number of character-string memory tables is set to 256).

If the contents of the memory table used for indirect specification are written in hexadecimal format, or if the specified memory table number is outside the available range, the display will not be updated.

- Important points when writing character-strings

The important points when displaying character-strings are the same as those that apply for indirect specification. See the “Important points when writing character-strings” when using direct specification (page 221).

### Example of Changing a Character-String in Indirect Specification

An example in which the character-strings being displayed are changed by adding the contents of the word allocated to the numeral memory table which is used in indirect specification is given below.

- Setting by the support tool

Perform the following setting with the support tool.

Numeral memory table number 51: DM0000 (registration word: 1)

Character-string memory table number 100: NT612G (6 digits)

Character-string memory table number 101: NT610C (6 digits)

Character-string memory table number 102: NT620S (6 digits)

Character-string memory table number 103: NT620C (6 digits)

Contents to be registered for the screen: Numeral memory table number 51

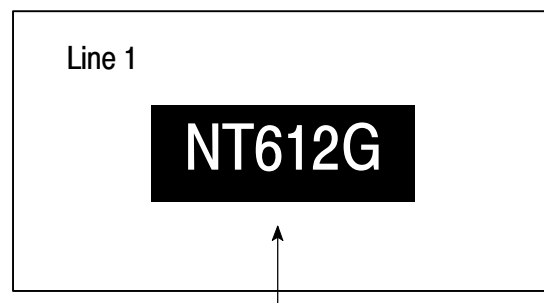

Display of character-string (specification of numeral memory table number 51 in indirect specification)

- PC program

Create the following PC ladder program.

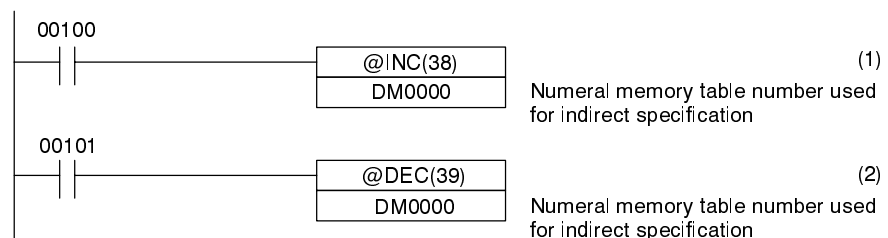

- Program operation

- (1) Each time contact 00100 comes ON, the display on the NT620S/620C changes to the next item in the following sequence.

NT612G → NT610C → NT620S → NT620C

- (2) Each time contact 00101 comes ON, the display on the PT changes to the next item in the following sequence.

NT620C → NT620S → NT610C → NT612G

In this example, the contents of numeral memory table 51, which is referenced using indirect specification, are not checked. When actually using the program, make sure that the contents of numeral table No. 51 are not outside the range 0100 to 0103.

### 5-2-4 Copying the Memory Table

The following describes the procedure to change displayed numerals or character-strings by copying the contents of the memory table.

Numerals and character-strings can be changed also by changing the contents of the allocated words. Refer to “Changing Displayed Numerals or Character-strings” (page 221, 223) explained before.

To change the numerals or character-strings displayed on the NT620S/620C, copy the data between the numeral or character-string memory tables by using the “copy memory table setting” of the PT status control area.

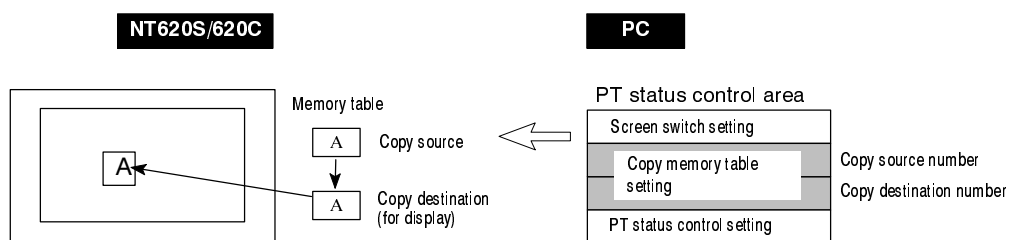

Write a memory table number etc. to the copy memory table setting area in the PT status control area in the PC memory. Data will be copied between the memory tables in the NT620S/620C and the displayed value will change accordingly.

This procedure is convenient to switch predetermined values or character-strings according to the situation. By preparing several units of contents, various contents can be displayed by switching them to suit the situation.

**[“Copy memory table setting” of the PT status control area]**

	15	14	13	12	11	10	9	8	7	6	5	4	3	2	1	0	Bit
Word n+1	0			Copy source memory table No. (3-digit BCD)													
Word n+2	Copy type			Copy destination memory table No. (3-digit BCD)													

) Copy memory table setting

Copy type:

- 0: Copy between the character-string memory tables
- 1: Copy between the numeral memory tables

Copy source and destination memory table numbers:

Character-string memory table: 000 to 999 (Numbers 256 to 999 are read-only memory tables. They cannot be used as copy destinations. In addition, depending on the setting made in the “system memory” settings of the support tool, it may not be possible to use numbers 256 through 999.

Numeral memory table: 000 to 999 (Depending on the setting made in the “system memory” settings of the support tool, it may not be possible to use numbers 512 through 999).



- Available allocation words

The PT status control area can be allocated to the following PC areas:

Symbol	C Series PCs	Allocated	CVM1/CV Series PCs	Allocated
DM	Data memory	✓	Data memory	✓
CH	Internal/Special Relay	✓	Internal/Special Relay	✓
TIM	Timer	×	Timer	×
CNT	Counter	×	Counter	×
HR	Holding Relay	✓	–	
AR	Auxiliary Relay	✓	Auxiliary Relay	×
LR	Link Relay	✓	–	

✓ : OK    × : NG

Since the special auxiliary relays of the CVM1/CV series PCs are allocated to the system, they cannot be used for purposes other than the system use.

The range of respective area varies with the type of PC. Refer to Appendix L “PC Memory Map” (page 354).

- Procedure**
1. Use the support tool to allocate the PT status control area (PC to PT) to the PC memory.
  2. Register the memory tables for the numerals and character-strings to be displayed when creating the screen data by using the support tool.  
 To display a character-string, use “character display” and specify the character-string memory table by using the support tool.  
 To display numerals, use “numeral display” and specify the numeral memory table by using the support tool.
  3. Set the copy source data to the memory table when creating the screen data by using the support tool.  
 Use “table edit”.
  4. Create a PC program to write the copy type, copy destination memory table number, and copy source memory table number to the “copy memory table” setting word in the PT status control area.

- Order for writing to the PT status control area (PC to PT)

First write the “copy destination memory table number”, and then, write the “copy source memory table number” to the PT status control area (PC to PT).

The NT620S/620C reads the area sometimes when the PC is writing the settings. If the “copy source memory table number” has been written first and is changed, unexpected memory table may possibly be changed.

- Allocated words that the NT620S/620C reads

The NT620S/620C reads the allocated words in the PC for the memory tables which need to be displayed. Even if the copy source memory table is allocated to a PC word, if it has not been displayed even once, it may be used at initialization only.

- Use of the “copy type”

Copy will not be executed when the “copy type” is other than “0” or “1”. The memory table copy is executed only when the contents of the area are changed. To repeat copying of the same copy source and same copy destination, write a value other than “0” or “1” for the copy type, and then, write a correct value again.

- Copying a numeral memory table

If the display method or the number of registered words include discrepancies, a numeral memory table may not be copied and displayed correctly.

**Application Example of Copying of a Character-String Memory Table**

This example gives a PC program to switch the character-string display on the screen by using the memory table copy operation as the allocated bit is turned ON and OFF.

- Support tool settings

Allocate the memory as shown below by using the support tool.

PT status control area allocation: CH 0100

Contents registered to the screen: Character-string memory table No. 4

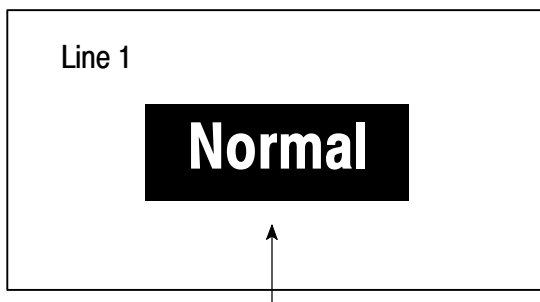

Character-string memory table No. 4

Character-string memory table settings

No.	Contents	Number of Character Digits
4	Normal	6 digits
10	Error	6 digits
11	Normal	6 digits

• PC ladder program

Create a PC ladder program as follows:

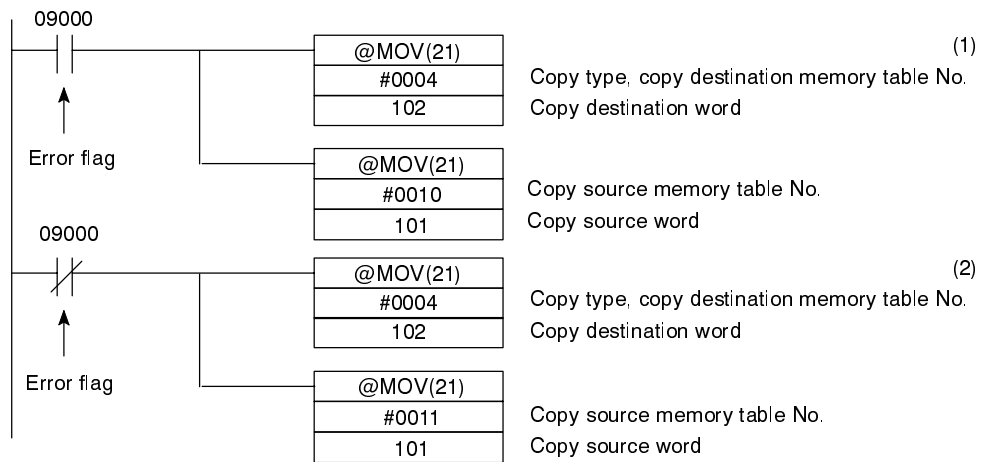

• Program operation

- (1) When an error occurs (bit 09000 turns ON), the NT620S/620C displays the message "Error".
- (2) When the error is cleared (bit 09000 turns OFF), the NT620S/620C display message reverts to "Normal".

### 5-2-5 Upgrading Graphs (Changing the Contents of Allocated Words)

The following describes the procedure to upgrade the graph on the NT620S/620C by changing the contents of the allocated words.

To change the graph display on the NT620S/620C, change the contents of the PC words to which the numeral memory tables have been allocated.

The graph display cannot use hexadecimal numbers. If hexadecimal numbers are set, the graph will not be displayed.

By writing a negative number (whose most significant digit is “F”) to the allocated word of a graph set as “Sign display “No””, the graph display will become 0 % and the % display will show “\*\*\*%”.

For the procedure to write numeral values to the allocated words of the numeral memory tables, refer to “Allocation Words and Display of the Memory Tables” (page 219).

For the procedure to change the contents of the numeral memory table (PC words), refer to “Changing Displayed Numerals or Character-strings (Changing the Contents of Allocated Words)” (page 221, 223).

- Available allocation words

The numeral memory tables can be allocated to the following PC areas:

Symbol	C Series PCs	Allocation	CV Series PCs	Allocation
DM	Data Memory	✓	Data Memory	✓
CH	Internal/Special Relay	✓	Internal/Special Relay	✓
TIM	Timer	△	Timer	△
CNT	Counter	△	Counter	△
HR	Holding Relay	✓	–	
AR	Auxiliary Relay	✓	Auxiliary Relay	×
LR	Link Relay	✓	–	

✓ : OK    △ : 1 word only    × : NG

Since the special auxiliary relays of the CVM1/CV series PCs are allocated to the system, they cannot be used for purposes other than the system use.

The range of respective area varies with the type of PC. Refer to Appendix L “PC Memory Map” (page 354).

## 5-3 Lamps and Touch Switches

### 5-3-1 Allocation Bits and Display of Lamps

Lamps are controlled by allocating them to the PC bits. Set the area and bit number.

- Available allocation bits

The lamps can be allocated to the following PC areas:

Symbol	C Series PCs	Allocated	CVM1/CV Series PCs	Allocated
DM	Data memory	✓	Data memory	✓
CH	Internal/Special Relay	✓	Internal/Special Relay	✓
TIM	Timer	×	Timer	×
CNT	Counter	×	Counter	×
HR	Holding Relay	✓	–	
AR	Auxiliary Relay	✓	Auxiliary Relay	×
LR	Link Relay	✓	–	

✓: OK    ×: NG

Since the special auxiliary relays of the CVM1/CV series PCs are allocated to the system, they cannot be used for purposes other than the system use.

The range of respective area varies with the type of PC. Refer to Appendix L “PC Memory Map” (page 354).

To set the data memory (DM), specify the word number and then the bit number (00 to 15).

### 5-3-2 Turning ON (lit) and OFF (unlit) the Lamps (Changing the Contents of Allocated Bits)

The following describes the procedure to change the lamp display status on the NT620S/620C by changing the contents of the allocated bits.

To change the lamp display status on the NT620S/620C, turn ON and OFF the lamp control bit allocated in the PC.

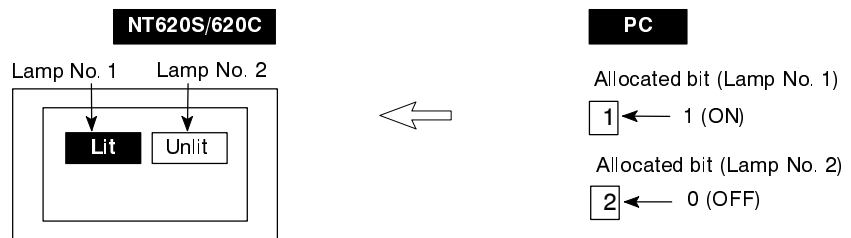

The lamp control bit indicates the lamp status as follows:

- 0 (OFF): Unlit
- 1 (ON): Lit (reverse display) or flashing

- Procedure**
1. Use the support tool to set the PC memory area where the lamp control bit is to be allocated to.
  2. Register the lamps to the screen when creating the screen data by using the support tool.
  3. Create a PC program to turn ON/OFF the lamp bit.

Use the support tool to set the lamp display attributes whether the lamp is lit or flashing when the lamp control bit is turned ON.

- Image and library lamp data

With the NT620S/620C, it is possible to set lamps that display any required image or library data in their lit status and in their unlit status. For details, see "Image Library LAMP Setting" (page 160).

#### Application Example to Make the Lamp Light or Flash

This example gives a procedure to control the bits to move a robot arm and turning the lamps ON and OFF.

- Support tool settings

Allocate the memory as shown below by using the support tool.

- Lamp No. 0: CH 000200 (output bit to raise robot arm), guide display message "UP"
- Lamp No. 1: CH 000201 (output bit to lower robot arm), guide display message "DOWN"
- Lamp No. 2: CH 000202 (output bit to rotate robot arm counterclockwise), guide display message "C/CLOCK"
- Lamp No. 3: CH 000203 (output bit to rotate robot arm clockwise), guide display message "CLOCK"

Lamp No. 4: CH 000204 (output bit to clamp rotate robot arm), guide display message "CLAMP"

Lamp No. 5: CH 000205 (output bit to unclamp rotate robot arm), guide display message "UNCLAMP"

Contents registered to the screen: Lamp No. 0 to No. 5

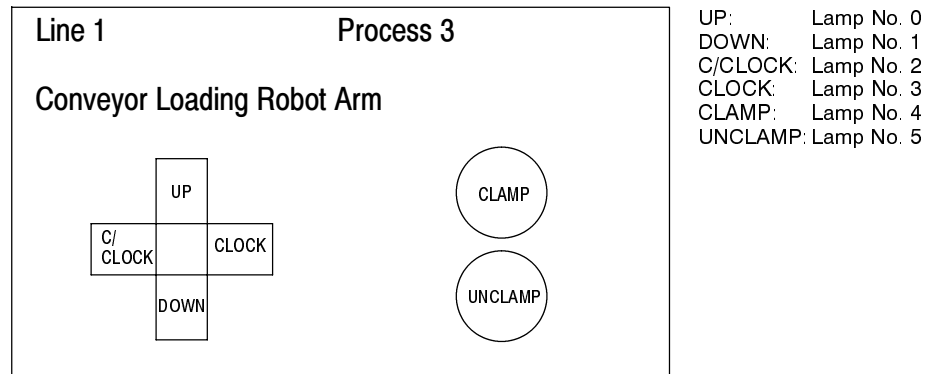

- PC ladder program

No PC ladder program is required to control the NT620S/620C. Only a program to control the robot arm movements is required.

- Program operation

When the ladder program to control the robot arm is executed, the lamps on the NT620S/620C screen turn ON and OFF in synchronization with the robot arm movement.

For example, lamp No. 0 lights when the robot arm moves up and goes out when it stops moving up.

### 5-3-3 Allocated Bits, and Display, of Touch Switches

#### Method for PC Notification and NT620S/620C Control

Two types of bit can be allocated to touch switches: notify bits, which serve to notify statuses to the PC, and control bits, which control the lighting (flashing) of the touch switches (for other functions, only lamp bits can be allocated). When a touch switch is pressed the notify bit status changes and, when the control bit is ON, the touch switch lights (or flashes).

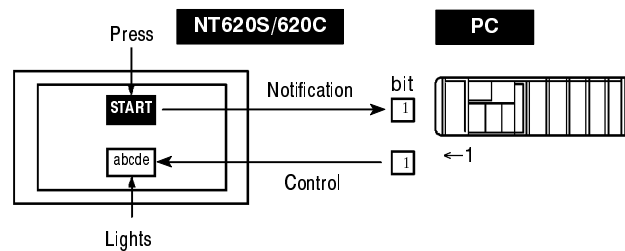

In order to notify the status of a touch switch to the PC, the touch switch must be allocated to a specified PC bit so that it can be managed. Designate the area and bit number.

To use touch switches for notification to the PC, the following settings must be made using the support tool: “touch switch” – “bit setting” – “notify bit”.

- Types of notification operation

When using Ver.2 or a later version of the direct connection function, it is possible to select one of four types of notification operation that occur when the touch switch is pressed (with Ver.1 of the direct connection function, the setting is fixed as “momentary”).

- Momentary

When the touch switch is pressed the bit comes ON and when it is released the bit goes OFF.

- Alternate

When the touch switch is pressed the bit comes ON if it is OFF and goes OFF if it is ON.

- Set

When the touch switch is pressed the bit comes ON, and it remains ON when the touch switch is released.

- Reset

When the touch switch is pressed the bit goes OFF, and it remains OFF when the touch switch is released.



- Important points relating to notification operations

Details on touch switch notification operations are tabled below.

Type of notification operation	When using host link When using NT link (DM area)	When using NT link (other than DM area)
Momentary	(1) Notification in word units (all other bits in the word are OFF)	(3) Notification in bit units
Alternate Set Reset	(2) Notification in word units (note that the word contents are read on display and notification is based on these contents)	(4) Notification in bit units

When using touch switch input notification, note the following points.

- In the case of (1) in the table, the other bits in the same word are turned OFF by notification.
- In the case of (2) in the table, since notification is executed on the basis of the contents of the word before display, the other bits in the word are not overwritten. However, if the contents of the word are changed at the PC during display, they will be rewritten based on the contents before display.
- If the screen is switched while a momentary key is pressed, the touch switch itself will disappear and the "OFF" status will be notified to the PC. This means that, in the case of (1) in the table, all the bits in the word will be set to the "OFF" status.
- When using the host link, or when using the NT link with the DM area, the notification operation is different for the momentary type and the other types, and they should not both be specified in the same word.

In the case of (3) and (4), notification has no effect on the other bits in the word.

- Possible bit allocations

Notify bits and control bits for touch switches can be allocated to the areas of the PC memory listed in the following table.

Symbol	C Series PCs	Allocated	CVM1/CV Series PCs	Allocated
DM	Data memory	✓	Data memory	✓
CH	Internal/Special Relay	✓	Internal/Special Relay	✓
TIM	Timer	×	Timer	×
CNT	Counter	×	Counter	×
HR	Holding Relay	✓	–	
AR	Auxiliary Relay	✓	Auxiliary Relay	×
LR	Link Relay	✓	–	

✓: OK    ×: NG

Since all the CVM1/CV-series special auxiliary relays are allocated to the system, they cannot be used for applications not related to the system.

The range of each memory area differs according to the PC type. See Appendix L “PC Memory Map” (page 354).

When making a data memory (DM) specification, specify the bit number (00 to 15) following the word number.

### 5-3-4 Lit (Flashing) and Unlit Touch Switch Statuses (Changing the Status of Allocated Bits)

This section describes how to change the statuses of allocated bits and thereby the statuses of the touch switches displayed by the NT620S/620C.

The statuses of touch switches displayed by the NT620S/620C are changed by switching the lamp bits allocated in the PC memory ON and OFF.

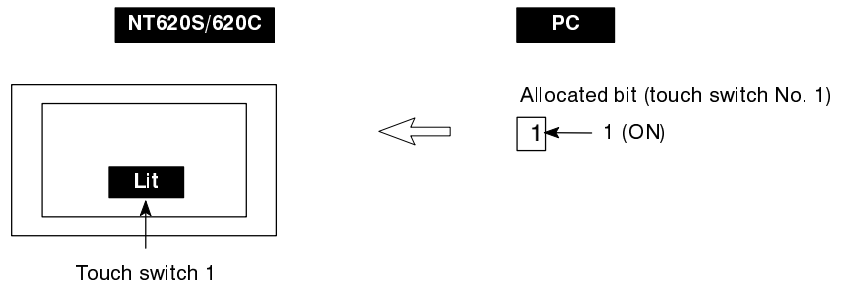

The status of the lamp bit reflects the touch switch status, as follows:

- 0 (OFF): Unlit
- 1 (ON): Lit (inverse display) or flashing

- Procedure**
1. Use the support tool to allocate the touch switch lamp bits to the PC memory.
  2. When creating the screen data using the support tool, register the touch switch for a screen.
  3. Create the PC program to switch the lamp bit of the touch switch ON and OFF.  
Set whether a touch switch will be continuously lit or blink when its bit has been turned ON by setting the support tool touch switch display attributes.

### 5-3-5 Notifying the PC that a Switch has been Pressed (Determining Touch Switch Status)

This section describes how the status of a touch switch (whether it has been pressed or not) is ascertained.

With the NT620S/620C, when a touch switch is pressed, the notify bit allocated to that touch switch in the PC memory is automatically notified.

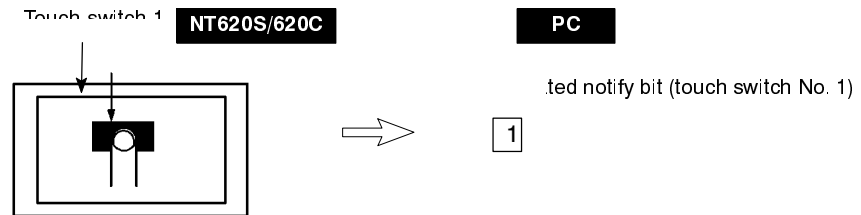

The status of the notify bit reflects the touch switch status, as follows:

Momentary: 0 (OFF) . . Not pressed  
1 (ON) . . . Pressed

Alternate: The allocated bit is switches to 1 (ON) if currently 0, and to 0 (OFF) if currently 1.

Set: The allocated notify bit is forcibly switched to 1 (ON).

Reset: The allocated notify bit is forcibly switched to 0 (OFF).

The status of a touch switch is determined by checking the ON/OFF status of its notify bit.

The touch switch notify bits can be allocated to the following areas of the PC memory.

Symbol	C Series PCs	Allocated	CVM1/CV Series PCs	Allocated
DM	Data memory	✓	Data memory	✓
CH	Internal/Special Relay	✓	Internal/Special Relay	✓
TIM	Timer	×	Timer	×
CNT	Counter	×	Counter	×
HR	Holding Relay	✓	–	
AR	Auxiliary Relay	✓	Auxiliary Relay	×
LR	Link Relay	✓	–	

✓: OK ×: NG

Since all the CVM1/CV-series special auxiliary relays are allocated to the system, they cannot be used for applications not related to the system.

The range of each memory area differs according to the PC type. See Appendix L “PC Memory Map” (page 354).

When making a data memory (DM) specification, specify the bit number (00 to 15) following the word number.

- Procedure**
1. Use the support tool to allocate the touch switch notify bits to the PC memory.
  2. When creating the screen data using the support tool, register the touch switch for a screen.
  3. Create the PC program to switch the notify bit of the touch switch ON and OFF.

• Important Points

Details on touch switch notification operations are tabled below.

Type of notification operation	When using host link When using NT link (DM area)	When using NT link (other than DM area)
Momentary	(1) Notification in word units (all other bits in the word are OFF)	(3) Notification in bit units
Alternate Set Reset	(2) Notification in word units (note that the word contents are read on display and notification is based on these contents)	(4) Notification in bit units

When using touch switch input notification, note the following points.

- In the case of (1) in the table, the other bits in the same word are turned OFF by notification.

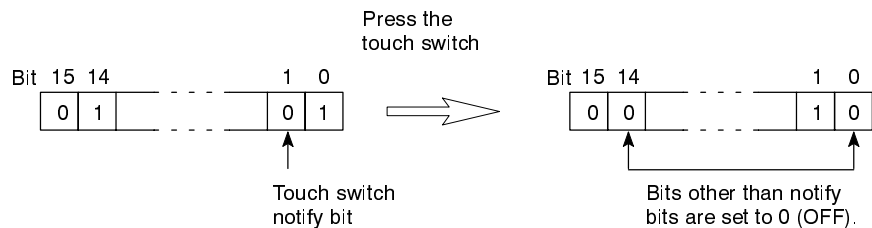

In the case of (2) in the table, since notification is executed on the basis of the contents of the word before display, the other bits in the word are not overwritten. However, if the contents of the word are changed at the PC during display, they will be rewritten based on the contents before display.

- If the screen is switched while a momentary key is pressed, the touch switch itself will disappear and the “OFF” status will be notified to the PC. This means that, in the case of (1) in the table, all the bits in the word will be set to the “OFF” status.
- When using the host link, or when using the NT link with the DM area, the notification operation is different for the momentary type and the other types, and they should not both be specified in the same word.

In the case of (3) and (4), notification has no effect on the other bits in the word.

**Application**

This example uses the touch switches as normal switches (bits) in order to use the NT620S/620C as an operating panel.

- Support tool settings

Make the following settings using the support tool.

Touch switch No. 10:

Function "Notify Bit"

Display attribute "Light"

Lamp bit CH05000 (Run flag) ... Guide message: "RUN"

Notify bit CH 06000

Touch switch No. 11:

Function "Notify Bit"

Display attribute "Light"

Lamp bit CH 05001 (Stop flag) ... Guide message: "STOP"

Notify bit CH 06001

Data registered for the screen: touch switch No. 10, touch switch No. 11

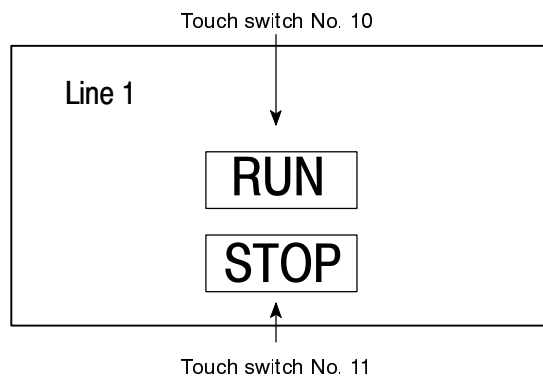

- PC program

Create the following ladder program.

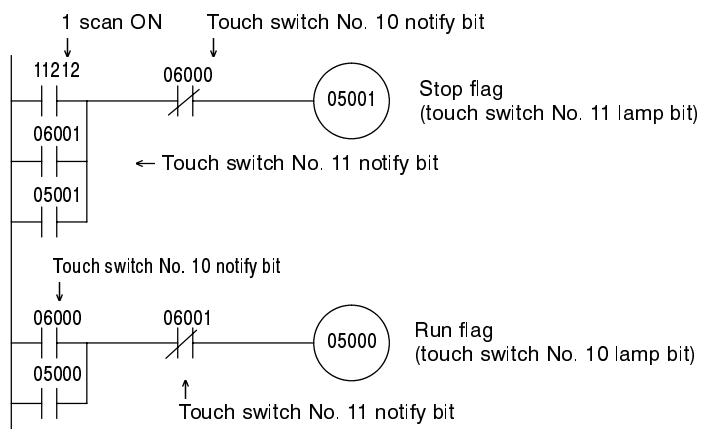

- Program operation

The operation when the program is executed is presented below.

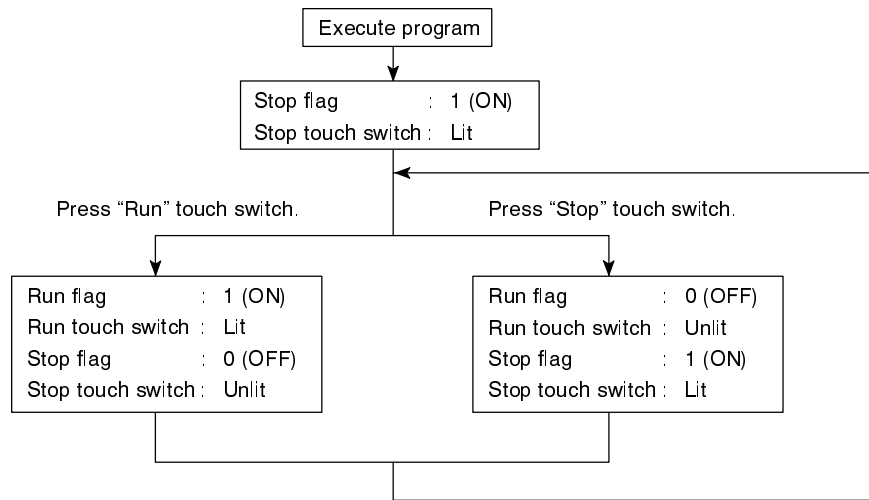

## 5-4 Numeral and Character-string Setting

### 5-4-1 Notification of Numbers to the PC

This section describes how the numerical data input at an NT620S/620C is ascertained by the PC.

In order to determine when numerical data has been input at the NT620S/620C, the numeral setting strobe flag in the PT status notify area is used. In order to determine the upgraded numeral memory table number, the “content upgrade memory table” in the PT status notify area is used.

When numerical data is input at the NT620S/620C, this is automatically notified to the PT status notify area (PT → PC) allocated in the PC memory as follows.

Notification of upgrade: PT status numeral setting strobe flag turned ON (1)

Upgraded numeral table number: Stored in the “content upgrade memory table”

When the PC reads the “content upgrade memory table” at the leading edge of the numeral setting strobe flag, it determines the numeral memory table number in which the numerical data that was changed at the NT620S/620C is stored.

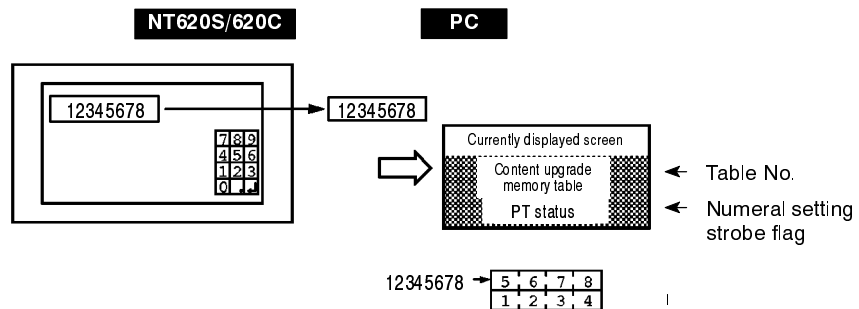

**[“Content upgrade memory table” in the PT status notify area and PT status]**

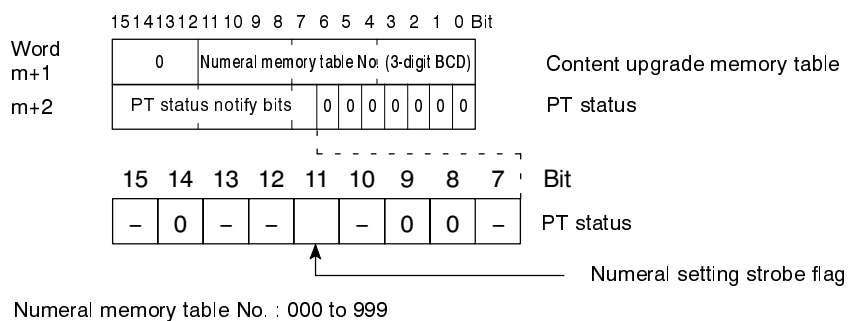

Data is written to the content upgrade memory table as three digits of BCD (binary coded decimal) data.

When the numeral setting strobe flag bit has been notified to the PC it returns to the OFF (0) status.

For details on the method for storing a number in the word allocated for the numeral table, see “Allocation Words and Display of the Memory Tables” (page 219).

• Restrictions on allocating words

The PT status notify area can be allocated to the PC memory areas listed in the following table.

Symbol	C Series PCs	Allocated	CVM1/CV Series PCs	Allocated
DM	Data memory	✓	Data memory	✓
CH	Internal/Special Relay	✓	Internal/Special Relay	✓
TIM	Timer	×	Timer	×
CNT	Counter	×	Counter	×
HR	Holding Relay	✓	-	
AR	Auxiliary Relay	✓	Auxiliary Relay	×
LR	Link Relay	✓	-	

✓: OK    ×: NG

Since all the CVM1/CV-series special auxiliary relays are allocated to the system, they cannot be used for applications not related to the system.

The range of each memory area differs according to the PC type. See Appendix L “PC Memory Map” (page 354).

- Procedure**
1. Use the support tool to allocate the PT status notify area (PT → PC) to the PC memory.
  2. Using the support tool, create a numeral setting screen and allocate the numeral memory table to the PC memory.
  3. Create a PC program for reading the “content upgrade memory table” in the PT status notify area when the numeral setting strobe flag in the PT status notify area comes ON (1).
  4. Read the allocated word for the numeral memory table number read in step 3.



- Disabling numeral input

Numeral input can be disabled by a PT status control area operation. For details, see 5-7 “NT620S/620C Status Control” (page 257).

**Application Example**

This example shows the reading of the numeral memory table number after a value has been changed by inputting numerical data at the NT620S/620C.

- Support tool settings

Make the following settings using the support tool.

Allocated word for the PT status notify area: CH0110

Numeral memory table entry No. 3: DM 0005 (registration word: 1)

Numeral memory table entry No. 4: DM 0006 (registration word: 1)

Data registered for the screens:

Numeral setting 1 ... Reference table “numeral memory table No. 3”

Numeral setting 2 ... Reference table “numeral memory table No. 4”

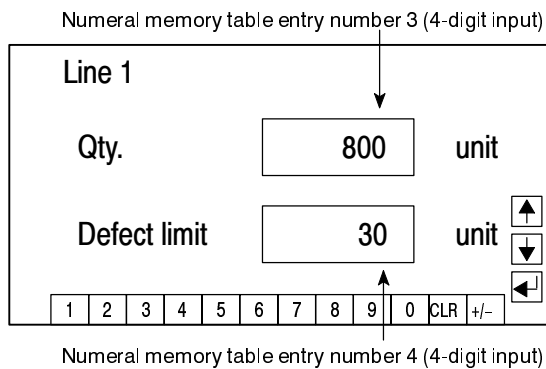

- PC program

Create the following PC ladder program.

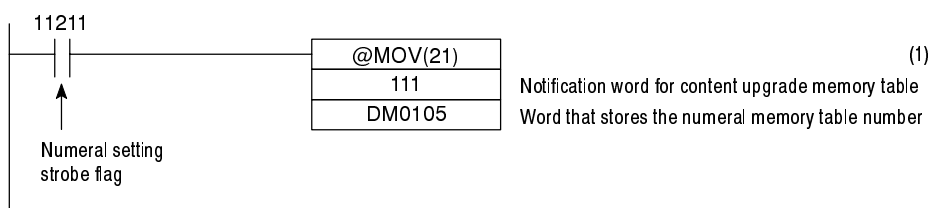

- Program operation

(1) When the numeral setting strobe flag (bit 11211) comes ON (1), the contents of CH 0111 (the word where the content upgrade memory table is located) are transferred to DM 0105. The number of the numeral memory table that contains the upgraded data is stored in DM 0105 (in this case it is 003 or 004).

If the numeral memory table is allocated to a PC word, the value input to it can be read easily by referring to the allocated word.

In this case, the contents of numeral memory table No. 3 are stored in DM 0005 and the contents of numeral memory table No. 4 are stored in DM 0006.

### 5-4-2 Notification of Character-string to the PC

This section describes how the character-string data input at an NT620S/620C is ascertained by the PC.

In order to determine when character-string data has been input at the NT620S/620C, the character-string setting strobe flag in the PT status notify area is used. In order to determine the upgraded character-string memory table number, the “content upgrade memory table” in the PT status notify area is used.

When character-string data is input at the NT620S/620C, this is automatically notified to the PT status notify area (PT → PC) allocated in the PC memory as follows.

Notification of upgrade: PT status character-string setting strobe flag turned ON (1)

Upgraded character-string table number:  
Stored in the “content upgrade memory table”

When the PC reads the “content upgrade memory table” at the leading edge of the character-string setting strobe flag, it determines the character-string memory table number in which the character-string data that was changed at the NT620S/620C is stored.

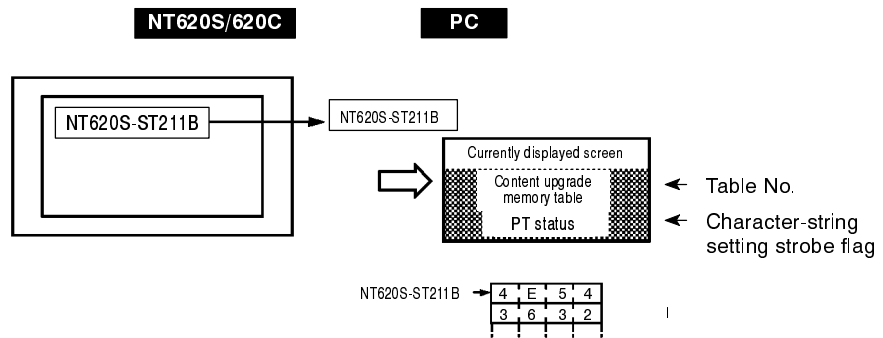

#### ["Content upgrade memory table" in the PT status notify area and PT status]

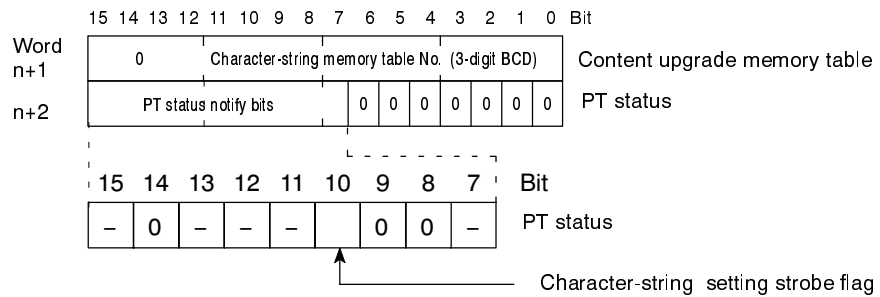

Character-string memory table No. : 000 to 999

Data is written to the content upgrade memory table as three digits of BCD (binary coded decimal) data.

When the character-string setting strobe flag bit has been notified to the PC it returns to the OFF (0) status.

For details on the method for storing a number in the word allocated for the character-string table, see “Allocation Words and Display of the Memory Tables” (page 219).

- Restrictions on allocating words

The PT status notify area can be allocated to the PC memory areas listed in the following table.

Symbol	C Series PCs	Allocated	CVM1/CV Series PCs	Allocated
DM	Data memory	✓	Data memory	✓
CH	Internal/Special Relay	✓	Internal/Special Relay	✓
TIM	Timer	×	Timer	×
CNT	Counter	×	Counter	×
HR	Holding Relay	✓	–	
AR	Auxiliary Relay	✓	Auxiliary Relay	×
LR	Link Relay	✓	–	

✓: OK    ×: NG

Since all the CVM1/CV-series special auxiliary relays are allocated to the system, they cannot be used for applications not related to the system.

The range of each memory area differs according to the PC type. See Appendix L “PC Memory Map” (page 354).

- Procedure**
1. Use the support tool to allocate the PT status notify area (PT → PC) to the PC memory.
  2. Using the support tool, create a character-string setting screen and allocate the character-string memory table to the PC memory.
  3. Create a PC program for reading the “content upgrade memory table” in the PT status notify area when the character-string setting strobe flag in the PT status notify area comes ON (1).
  4. Read the allocated word for the character-string memory table number read in step 3.
- Disabling character-string input

Character-string input can be disabled by a PT status control area operation. For details, see 5-7 “NT620S/620C Status Control” (page 257).

**Application Example**

This example shows the reading of the character-string memory table number after a value has been changed by inputting character-string data at the NT620S/620C.

- Support tool settings

Make the following settings using the support tool.

Allocated word for the PT status notify area: CH0110

Character-string memory table entry No. 2: DM0120 (registration word: 10)

Character-string memory table entry No. 3: DM0130 (registration word: 10)

Data registered for the screens:

Character-string setting 1 ... Reference table “character-string memory table No. 2”

Character-string setting 2 ... Reference table “character-string memory table No. 3”

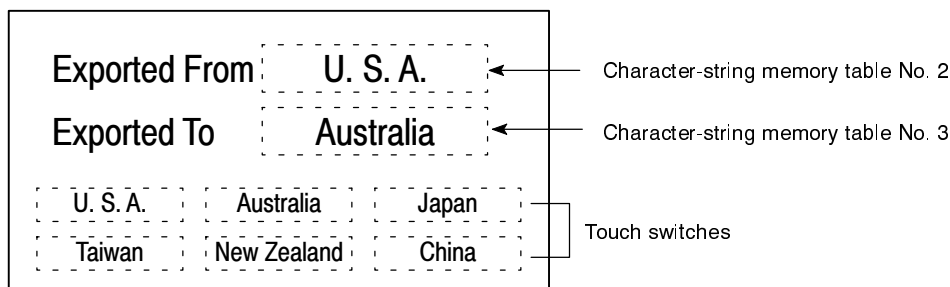

- PC program

Create the following PC ladder program.

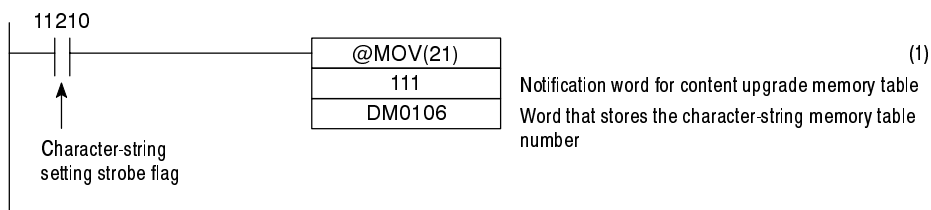

- Program operation

(1) When the character-string setting strobe flag (bit 11211) comes ON (1), the contents of CH0111 (the word where the content upgrade memory table is located) are transferred to DM 0106. The number of the character-string memory table that contains the upgraded data is stored in DM 0106 (in this case it is 0002 or 0003).

If the character-string memory table is allocated to a PC word, the value input to it can be read easily by referring to the allocated word.

In this case, the contents of character-string memory table No. 2 are stored in DM 0120 to DM 0129 and the contents of character-string memory table No. 3 are stored in DM 0130 to DM 0139.

## 5-5 Alarm Lists

### 5-5-1 Allocated Bits of Bit Memory Tables

The alarm list function automatically displays and clears alarm messages (contents of character-string memory tables) that correspond to the allocated bits of memory tables, in accordance with the status of these bits.

- Available allocation bits

The bit memory tables can be allocated to the following PC areas.

Symbol	C Series PCs	Allocated	CVM1/CV Series PCs	Allocated
DM	Data memory	✓	Data memory	✓
CH	Internal/Special Relay	✓	Internal/Special Relay	✓
TIM	Timer	×	Timer	×
CNT	Counter	×	Counter	×
HR	Holding Relay	✓	–	
AR	Auxiliary Relay	✓	Auxiliary Relay	×
LR	Link Relay	✓	–	

✓: OK    ×: NG

Since the special auxiliary relays of the CV series PCs are allocated to the system, they cannot be used for purposes other than system use.

The range of respective area varies with the type of PC. Refer to Appendix L “PC Memory Map” (page 354).

When data memory (DM) is specified, specify the bit number (00 to 15) after the word number.

### 5-5-2 Displaying Alarm Lists (by Using Bit Memory Table Allocation)

This section explains the actual procedure used to display the alarm messages of the alarm list function on the screen of the NT620S/620C.

In order to display an alarm message, the allocated bit of the bit memory table allocated to the PC has to be switched ON.

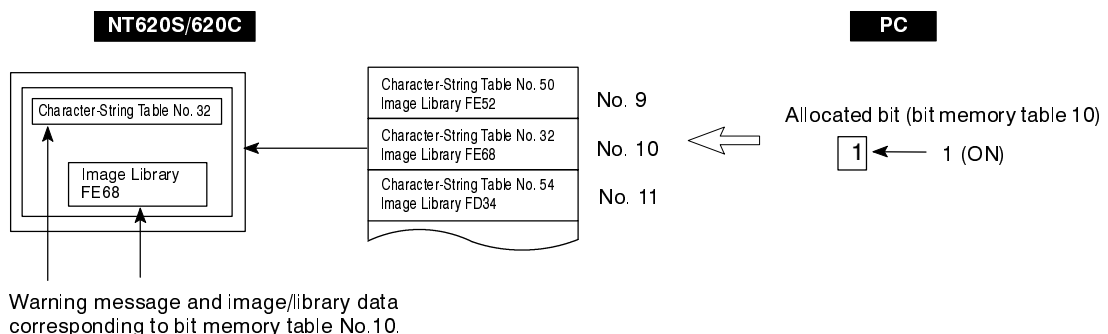

The relationship between the status of the allocated bit of the bit memory table and the corresponding alarm message is as follows:

- 0 (OFF): Deleted
- 1 (ON): Displayed

- Procedure**
1. Select "TBL EDIT" from the support tool editing menu, set the allocated bit of the bit memory table in the PC area, then set the corresponding alarm message.
  2. When creating screen data with the support tool, register the alarm list specified by the bit memory table in (1) above for the screen.
  3. Create the PC program to switch the allocated bit of the bit memory table ON and OFF.
- Image/library data corresponding to alarm messages

Apart from alarm messages, image/library data can also be set for bit memory tables. The alarm list is composed of touch switches and touching (pressing) an alarm message will display the corresponding image/library data for your guidance.

**Example of Alarm List Display**

In this example, if the temperature in a water tank rises above the upper limit, a bit is turned ON, and the alarm message corresponding to it is displayed.

- Support tool settings

The following settings are made using the support tool.

- Bit memory table No. 20 : CH 001512
- Bit memory table No. 21 : CH 000407
- Bit memory table No. 22 : AR 000000
- Bit memory table No. 23 : LR 001003
- Bit memory table No. 24 : LR 001004
- Data registered for the screen: Alarm list

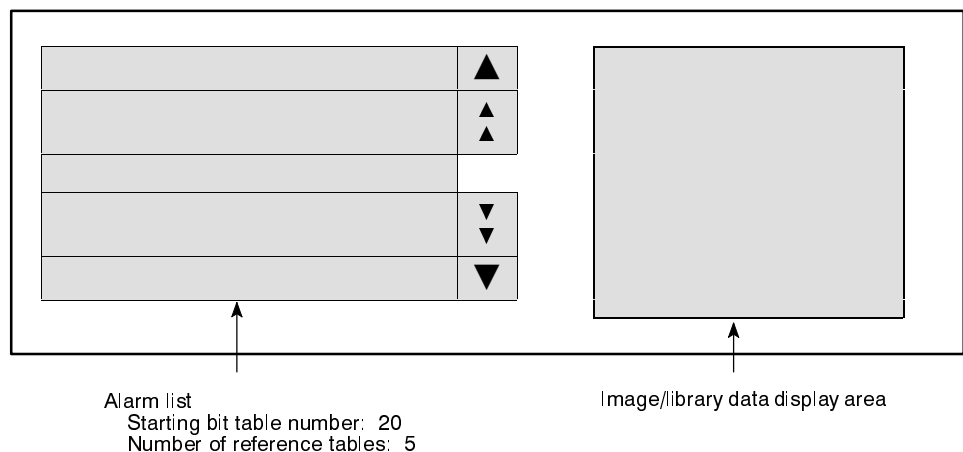

- PC program

A ladder program to control the NT620S/620C is not required.

• NT620S/620C operation

When the created alarm message screen is displayed, the following operations will take place in accordance with the status of the allocated bits.

- When all allocated bits are OFF

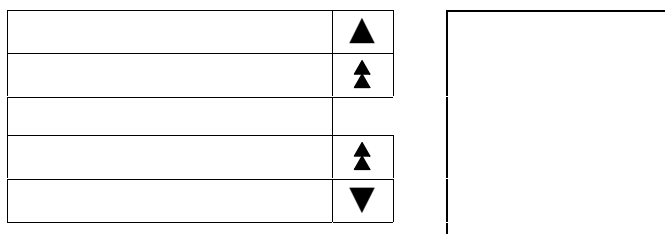

↓

- When bit AR0000 comes ON

Contents of character-string memory table corresponding to bit memory table No. 22

↓

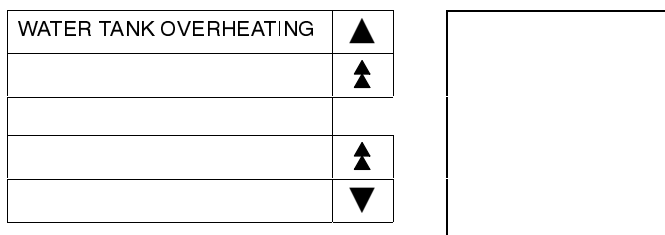

↓

- If bit 00407 then comes ON

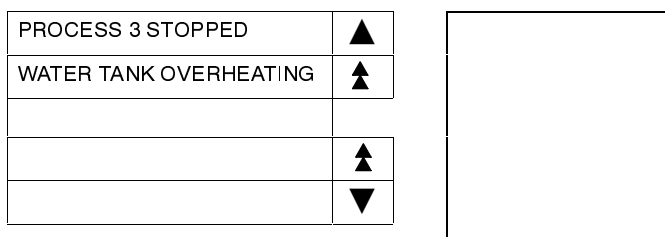

If an alarm list with multiple lines is created, alarms are displayed in descending order of bit memory table numbers. If the bit memory tables are set in ascending order of priority, the display will also be arranged in accordance with the order of priority.

↓

- When the second from top alarm message is pressed

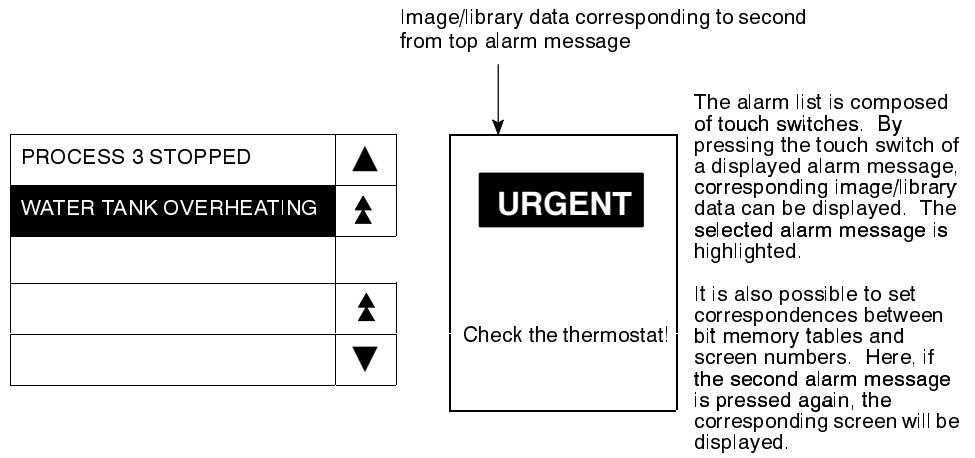

↓

- When bit 00407 returns to the OFF status

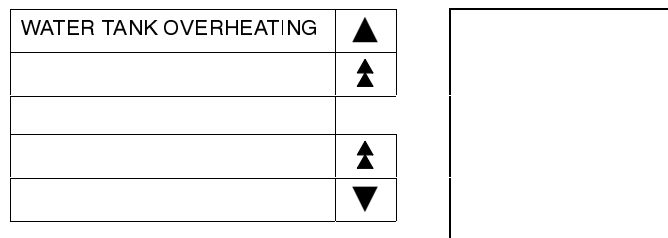



## 5-6 Clock Function

The NT620S/620C has a clock function for setting the date and time.

This section explains how to set the date and time, and how to notify the date and time to the PC.

### Reference

When the voltage of the battery in the NT620S/620C becomes low, the clock function will not operate correctly when the power is switched off.

### 5-6-1 About the Clock Function

The clock function uses the numeral memory tables numbered 247 through 255: these memory tables are used exclusively for clock data.

As shown in the table below, numbers 247 through 253 are for display and reading only, and numbers 254 and 255 are for time setting. Numbers 247 through 253 store clock data which is updated by the internal clock of the NT620S/620C. This data cannot be rewritten by the PC.

Function	Numeral memory table	Bit	Information	Value	Remarks
Display/reading only	247		Second	00 to 59	
	248		Minute	00 to 59	
	249		Hour	00 to 23	24-hour system
	250		Date	01 to 31	
	251		Month	01 to 12	
	252		Year	00 to 99	Last 2 digits of year
	253		Day of week	00 to 06	See below
Setting only	254	0 to 7	Second	00 to 59	24-hour system
		8 to 15	Minute	00 to 59	
	255	16 to 23	Hour	00 to 23	Last 2 digits of year
		24 to 31	Date	01 to 31	
		0 to 7	Month	01 to 12	Last 2 digits of year See below
		8 to 15	Year	00 to 99	
		16 to 23	Day of week	00 to 06	
		24 to 31	Vacant	Always 00	

\* The numerical values that correspond to the days of the week are as follows:

Day of week	Sun	Mon	Tue	Wed	Thu	Fri	Sat
Value	00	01	02	03	04	05	06

Setting example: April 27, 1995, 14:53:30

254    

27	14	53	30
----	----	----	----

255    

00	04	95	04
----	----	----	----

### 5-6-2 Date and Time Display

In order to display the date or time, an area in which the contents of numeral memory tables 247 through 253 can be displayed must be set during screen creation with the support tool.

Numeral memory tables 247 through 253 store clock data which is updated by the internal clock of the NT620S/620C. This data cannot be rewritten by the PC.

### 5-6-3 Date and Time Setting

When the date and time are set from the PC, the contents of the numeral memory tables numbered 254 and 255 are rewritten. It is possible to use the method of copying between memory tables to set the time, as shown below.

**Reference**

- It is also possible to set the date and time by using function key [F3] (Time) on the "Tool Settings" screen of the support tool.  
For details, see the NT-series Support Tool Operation Manual (V028-E1-01).
- It is also possible to set the date and time by using the "Calendar & Clock" option of the I/O Check Menu in the maintenance mode.
- It is also possible to set the date and time by rewriting the contents of numeral memory tables 254 and 255 using the numeral setting function.
- The maximum clock error per month is +67 seconds to -57 seconds. Periodically correct the error.

Numeral memory tables 254 and 255 are exclusively for time setting. They can be allocated to an area of the PC for other uses. It is possible to rewrite the contents of these memory tables by first writing the new setting into tables other than 254 and 255 and then copying it into tables 254 and 255 by using the memory table copy function.

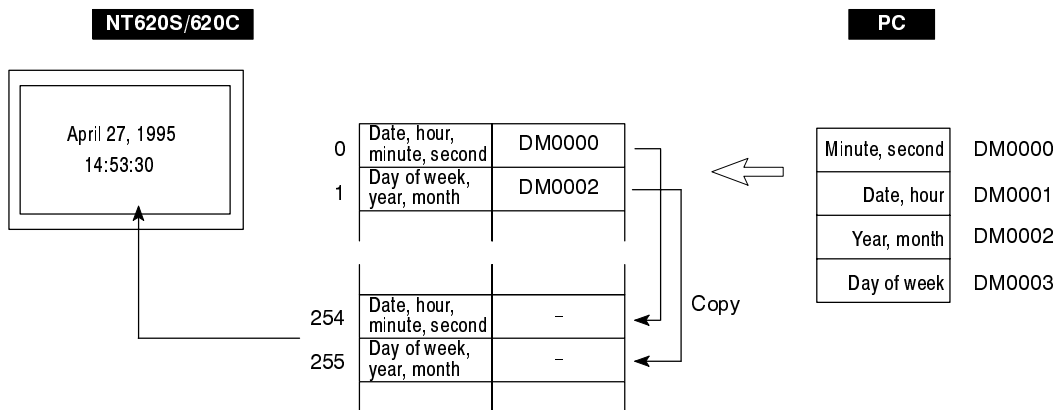

- Available allocation words

The memory tables can be allocated to the following PC areas.  
For time setting, two words have to be allocated for each table.

Symbol	C Series PCs	Allocated	CVM1/CV Series PCs	Allocated
DM	Data memory	✓	Data memory	✓
CH	Internal/Special Relay	✓	Internal/Special Relay	✓
TIM	Timer	×	Timer	×
CNT	Counter	×	Counter	×
HR	Holding Relay	✓	–	
AR	Auxiliary Relay	✓	Auxiliary Relay	×
LR	Link Relay	✓	–	

✓: OK    ×: NG

Since the special auxiliary relays of the CV series PCs are allocated to the system, they cannot be used for purposes other than system use.

The range of respective area varies with the type of PC. Refer to Appendix L “PC Memory Map” (page 354).

- Procedure**
1. Allocate the two memory tables that are to be the copy source for the setting to areas in the PC.  
Two words must be allocated for each table.
  2. Next, at the PC, specify the date and time that are to be set in numeral memory tables 254 and 255 in these allocated words.
  3. Copy the settings from the copy source numeral memory tables to numeral memory tables 254 and 255.

For the method for copying memory tables, see “Copying the Memory Table” (page 226).

- Important points concerning the numeral memory tables used for the clock function

Do not allocate the numeral memory tables to which the clock function is assigned (numbers 247 to 255) to PC words.

Numeral memory tables 247 through 253 are exclusively for display (read only). Do not attempt to write data to them by using numeral settings or by copying between memory tables.

Numeral memory tables 254 and 255 are exclusively for time setting (write only). Do not use them for numeral displays or graph displays.

Initial values set with the support tool are invalid in the case of numeral memory tables 247 through 255.

**Date and Time Setting Example**

The following is an example of setting the date and time from the PC.  
 In this example, a C200H (type C200H-CPU11,21,22,23,31) which has a time function is used. The time function is assigned to words AR 18 to 21 of the C200H.

- Support tool settings

The following settings are made using the support tool.

- PT status control area: CH0100
- Numeral memory table No. 264: DM0000 (registration word: 2)
- Numeral memory table No. 265: DM0002 (registration word: 2)
- Data registered on the screen: Numeral memory table Nos. 247 to 252

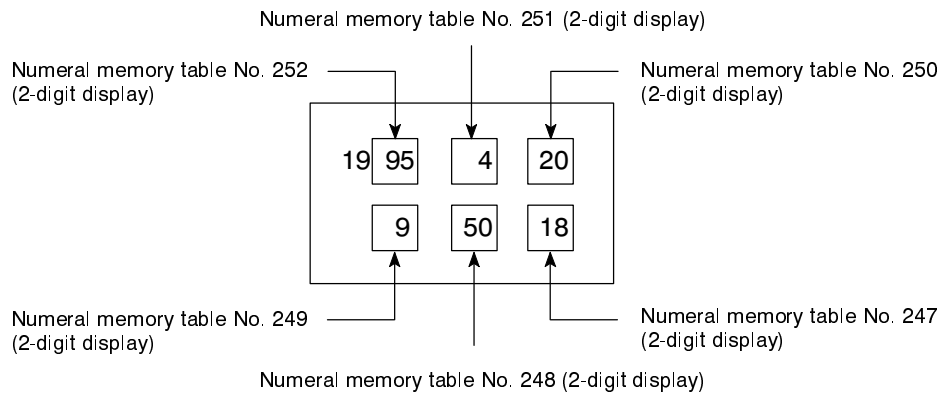

- PC program

Create the PC program in the way shown below.

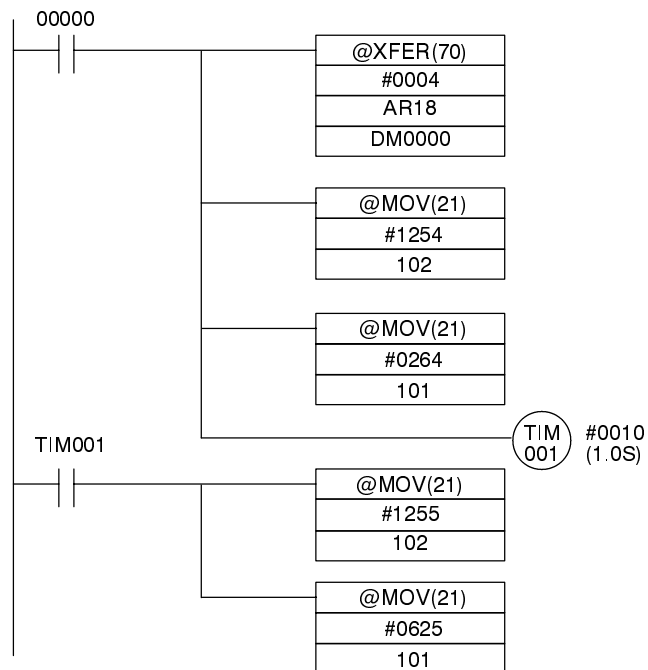

- Program operation

When the created screen is displayed on the NT620S/620C and the program is executed, the operation is as follows.

- (1) When bit 00000 comes ON, the date and time (AR 18 to 21) set in the PC are read, and written to the words (DM0000 to 0003) allocated to numeral memory tables 264 and 265.
- (2) Copy the contents of numeral memory table 264 (day, hour, minute, second) into numeral memory table 254, which is used for setting the clock function.
- (3) After waiting about a second for the memory table copy operation in step (2) to be completed, copy the contents of numeral memory table 265 (day of the week, year, month) into numeral memory table 255, which used for setting the clock function.

The date and time set at the PC will also be set at the NT620S/620C and displayed.

### 5-6-4 Notification of the Date and Time to the PC

The date and time set at the NT620S/620C can be notified to the PC. The numeral memory tables numbered 247 through 253 are used for display. They cannot be allocated to PC areas.

The method used to notify the date and time is copying between memory tables.

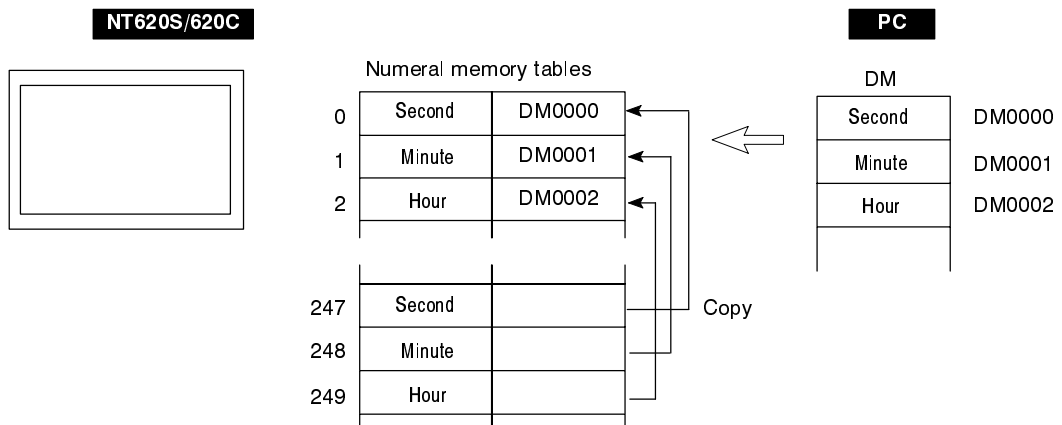

- Procedure**
1. Allocate an area in the PC to the numeral memory tables (number corresponding to the data to be read) that are to be made the copy destination.
  2. Copy the contents of numeral memory tables 247 to 253 to the numeral memory tables allocated as the copy destination in step (1).  
The copied date and time is notified to the area in the PC.

- Important points concerning numeral memory tables used for the clock function

Numeral memory tables 247 through 253 store clock data which is updated by the internal clock of the NT620S/620C. This data cannot be rewritten by the PC.

Numeral memory tables 247 through 253 are exclusively for display (read only). Do not attempt to write data to them by using numeral settings or by copying between memory tables.

Do not allocate the numeral memory tables to which the clock function is assigned (numbers 247 to 255) to PC words.

**Example of Reading the Time Set for the NT620S/620C**

This is the procedure for reading the time (hour, minute) set for the NT620S/620C.

- Settings with the support tool

The following settings are made using the support tool.

PT status control area: CH0100  
 Numeral memory table No. 258: DM0000 (one registered word)  
 Numeral memory table No. 259: DM0001 (one registered word)

- PC program

Create the PC program in the way shown below.

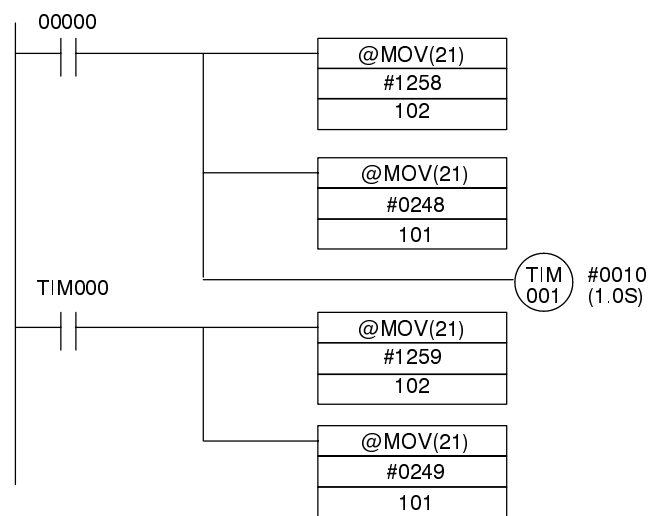

- Program operation

When the program is executed, the operation is as follows.

- (1) When bit 00000 comes ON, the contents (“minute”) of numeral memory table 248, which is used for reading the clock function, are copied to numeral memory table 258.
- (2) After waiting about a second for the memory table copy operation in step (1) to be completed, copy the contents of numeral memory table 249 (“hour”), which used for reading the clock function, into numeral memory table 259.

The hour and minute set in the NT620S/620C are stored in DM0000 and DM0001, which are the words allocated to numeral memory tables 258 and 259.

## 5-7 NT620S/620C Status Control

In order to control the status of the NT30/30C from the PC, the “PT status control bits” in the PT status control area are used.

The statuses of the NT620S/620C can be controlled from the PC by writing control data to the “PT status control bits” of the PT status control area allocated in the PC memory.

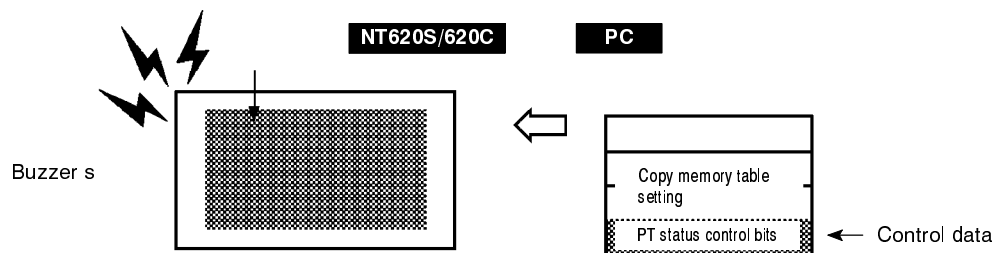

### 5-7-1 Controllable NT620S/620C Functions

[“PT status control bits” of the PT status control area]

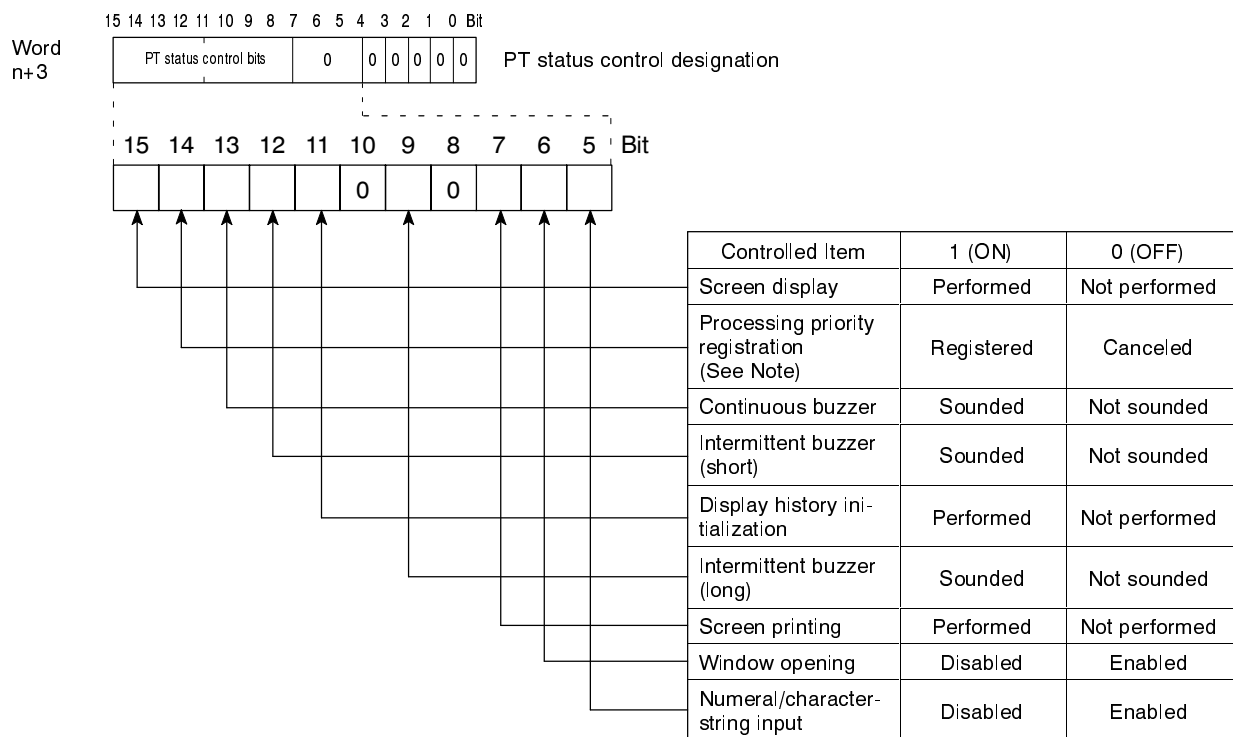

Note: Priority registration is only effective when NT link (1:N) is set.

The PC status control bits remain unchanged if the NT620S/620C status is changed with the screen attributes or memory switches, which means that the statuses of the PT status control bits do not match the actual status of the NT620S/620C. For example, the buzzer may sound even though the setting for continuous buzzer bit 13 is “OFF”.

In this kind of case, control the NT620S/620C by using the PT status control bits.

- Screen display (bit 15)

The screen display bit is used to display and clear the screen to prevent “burn-in” on the CRT. Set bit 15 to 0 (OFF) to clear the screen. In the case of the NT620C, the backlight also goes off at the same time.

When the screen has been cleared, the last displayed screen can be redisplayed either by turning Bit 15 ON, or by pressing a touch switch. The backlight also comes back on.

**Reference**

- Instead of turning Bit 15 ON, a screen can be displayed by specifying its screen number. For details on screen switching, see “Switching the Screen Display” (page 207).
- If a screen disappears while bit 15 is ON, switch bit 15 OFF and then back ON again.

- Priority registration for processing (NT link 1:N connections only) (bit 14)

It is possible to register one of the multiple PTs connected by the 1:N NT link method to have processing priority. The PT for which bit 14 is set ON (1) is given priority over the other PTs and has a higher response speed for display, touch switches, etc.

When bit 14 is turned OFF (0), this registration is canceled and the normal response speed is reinstated. If priority registration is set for more than one PT, the one for which the registration was made last will have priority.

By monitoring C200HX/HG/HE words, the unit number of the PT for which priority registration has been set can be confirmed. For details on the monitoring operation at the PC side, refer to the manual for the PC used.

**[Connection to RS-232C port of C200HX/HG/HE]**

Channel	Bit	Function
CIO265CH (standard port) CIO284CH (port A) (*) CIO285CH (port B) (*)	0	Unit No.0 Communication in progress flag, ON when connected
	1	Unit No.1 Communication in progress flag, ON when connected
	2	Unit No.2 Communication in progress flag, ON when connected
	3	Unit No.3 Communication in progress flag, ON when connected
	4	Unit No.4 Communication in progress flag, ON when connected
	5	Unit No.5 Communication in progress flag, ON when connected
	6	Unit No.6 Communication in progress flag, ON when connected
	7	Unit No.7 Communication in progress flag, ON when connected
	8	Unit No.0 Priority registration lamp, ON when registered
	9	Unit No.1 Priority registration lamp, ON when registered
	10	Unit No.2 Priority registration lamp, ON when registered
	11	Unit No.3 Priority registration lamp, ON when registered
	12	Unit No.4 Priority registration lamp, ON when registered
	13	Unit No.5 Priority registration lamp, ON when registered
	14	Unit No.6 Priority registration lamp, ON when registered
15	Unit No.7 Priority registration lamp, ON when registered	

(\*) This is the port of the communication board.



- Continuous buzzer (bit 13), short intermittent buzzer (bit 12) and long intermittent buzzer (bit 9)

The “continuous buzzer” sounds continuously without interruption.

The “short intermittent buzzer” sounds for 0.5 seconds at 0.5 second intervals.

The “long intermittent buzzer” sounds for 1.0 seconds at 1.0 second intervals. If “1” (ON) is specified for more than one of the three buzzers at the same time, the buzzers will sound in accordance with the following order of priority:

1. Continuous buzzer
2. Intermittent buzzer (short)
3. Intermittent buzzer (long)

Another way to stop a buzzer sounding is to use a touch switch to which the buzzer stop attribute function is allocated.

Whether or not the buzzer actually sounds also depends on the setting of the “buzzer” memory switch of the NT620S/620C. For details on this setting, see “Using the buzzer” (page 87).

In addition to PT status bit operations, the buzzer status can also be controlled by using screen attributes. The screen attributes are set with the support tool.

Buzzer attribute: Set whether the screen will sound or not when a screen is displayed, and, if it sounds, the type of buzzer.

- Display history initialization (bit 11)

“Display history initialization” initializes the display history in the NT620S/620C.

When bit 11 is switched from “0” (OFF) to “1” (ON), the display history in the NT620S/620C is initialized.

After initialization, it returns to the “0” (OFF) status.

- Screen printing (bit 7)

Hard copies of the screen can be made by connecting a printer to the NT620S/620C.

When bit 7 is set from “0” (OFF) to “1” (ON), printing of the screen displayed at that time starts. Note that it is not possible to stop printing part way through. Start printing after confirming that bit 7 (printer operating status) of the PT status notification area is in the “0” (OFF) status.

When printing starts and bit 7 of the PT status notification area has been set to the “1” (ON) status, the “screen printing” bit is returned to “0” (OFF).

- Window opening (bit 6)

It is possible to display a partial screen overlying the currently displayed screen. This partial screen is called a “window”, and control of windows can be allocated to touch switches. “Window opening” is specified to disable the opening of windows using touch switches.

When bit 6 is set to “1” (ON), windows will not open even if a window opening touch switch is pressed, and currently open windows are closed.

- Numeral/character-string input (bit 5)

This bit makes it possible to disable the input of numerical values and character-strings into numeral/character-string input fields.

When bit 5 is set to “1” (ON), it will not be possible to input anything into input fields by pressing touch switches to which numeric keys and character-string keys are allocated.

## 5-7-2 How to Control NT620S/620C Functions

This section describes how to control the functions of the NT620S/620C.

- Restrictions on allocating words

The PT status control area (PC → PT) can be allocated to the PC memory areas listed in the following table.

Symbol	C Series PCs	Allocated	CVM1/CV Series PCs	Allocated
DM	Data memory	✓	Data memory	✓
CH	Internal/Special Relay	✓	Internal/Special Relay	✓
TIM	Timer	×	Timer	×
CNT	Counter	×	Counter	×
HR	Holding Relay	✓	–	
AR	Auxiliary Relay	✓	Auxiliary Relay	×
LR	Link Relay	✓	–	

✓: OK    ×: NG

Since all the CVM1/CV-series special auxiliary relays are allocated to the system, they cannot be used for applications not related to the system.

The range of each memory area differs according to the PC type. See Appendix L “PC Memory Map” (page 354).

- Procedure**
1. Use the support tool to allocate the PT status control area (PC → PT) to the PC memory.
  2. Create a PC program to write control data to the “PT status control bits” of the PT status control area.

- Control timing of PT status control bits

The PT status control area (PC → PT) is not read when the NT620S/620C starts up. It is only read, and control is only executed, when the contents of the PT status control area are changed after the NT620S/620C has been started up.

Since control of the NT620S/620C statuses is executed after the bits corresponding to the PT status control bits have changed, to execute control again the corresponding bits must be specified again.

### Application

This example is of the NT620S/620C being used as a warning lamp by using PT status control bits.

- Support tool settings

Make the following setting using the support tool.

Allocated word for the PT status control area: CH0100

• PC program

Create the following PC ladder program.

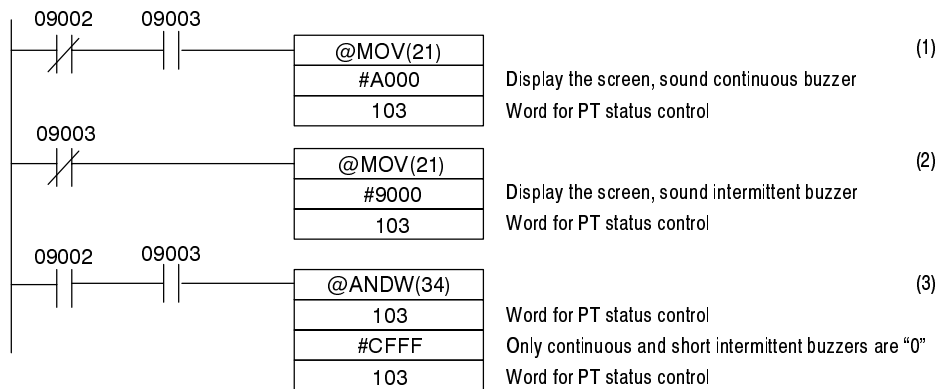

• Program operation

- (1) The PT status control bits are set as shown below when bit 09002 turns OFF. This command block is not executed when bit 09003 is ON.

Screen display (bit 15)	1 (Performed)
Continuous buzzer (bit 13)	1 (Sounded)

The NT620S/620C continuous buzzer sounds.

- (2) The PT status control bits are set as shown below when bit 09003 turns OFF.

Screen display (bit 15)	1 (Performed)
Short intermittent buzzer (bit 12)	1 (Sounded)

The NT620S/620C intermittent buzzer sounds.

- (3) The PT status control bits are set as shown below when both bits 09002 and 09003 turn ON.

Continuous buzzer (bit 13)	0 (Not sounded)
Short intermittent buzzer (bit 12)	0 (Not sounded)

The NT620S/620C buzzer stops.

## 5-8 Notification of the Operating Status to the PC (Determining the NT620S/620C Operating Status)

The status (operating statuses, etc.) of the NT620S/620C can be determined from the PC by reading the “PT status” word in the PT status notify area allocated in the PC memory.

By reading the “PT status” in the PT status notify area allocated to the PC, it is possible to ascertain the operating status of the NT620S/NT620C and other information.

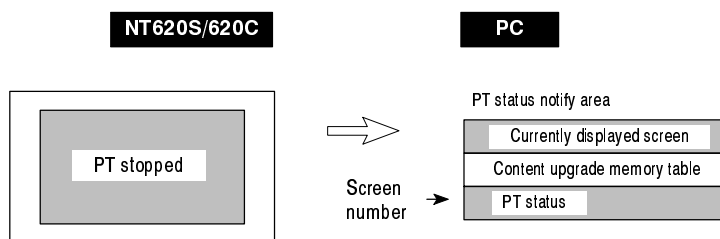

### 5-8-1 Ascertainable NT620S/620C Statures (Notified Operating Statuses)

[“PT status notification bits” of the PT status notify area]

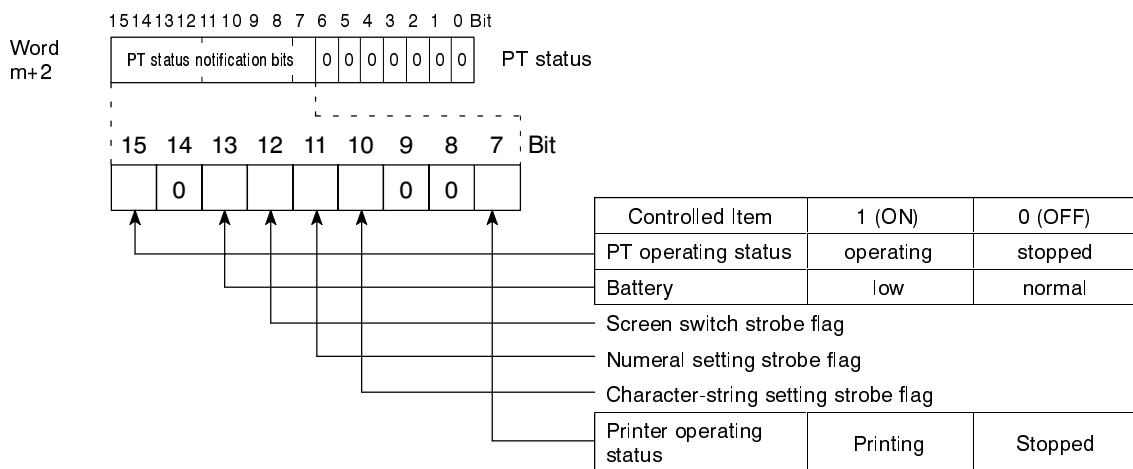

- PT operating status (bit 15)

When the NT620S/620C is in the RUN mode this bit is set to ON (1). In other modes and while the system menu is displayed it is OFF (0). When this bit is OFF allocated bits and words cannot be read or written to.



**Caution**

To ensure system safety, be sure to periodically read the PT operating status bit from the host in order to ensure that the PT is always operating normally.

- Battery (bit 13)

If the voltage of the backup battery for the NT620S/620C memory becomes low, this bit is set to ON (1).

- Screen switch strobe flag (bit 12)

When the screen displayed on the NT620S/620C is switched by a designation from the PC, by the standalone function or by the operation of the allocated bit of a bit memory table, the screen switch strobe flag comes ON (1). On notification to the PC, it returns to the OFF (0) status.

For details on how the screen switch strobe flag is used, see “Notifying the display screen to the PC” (page 212).

- Numeral setting strobe flag (bit 11)

When numerical data is input to a numeral table using the NT620S/620C numeral setting function, the numeral setting strobe flag comes ON (1). On notification to the PC, it returns to the OFF (0) status.

For details on how the numeral setting strobe flag is used, see “Notification of Numbers to the PC” (page 241).

- Character-string setting strobe flag (bit 10)

This bit is set to “1” when a character-string is input to a character-string memory table by using the character-string setting function. On notification to the PC, the bit is set to “0” (OFF).

For details, see “Notification of Character-string to the PC” (page 244).

- Printer operating status (bit 7)

This bit is set to “1” (ON) when screen printing is executed at a printer connected to the NT620S/620C in accordance with an instruction from a touch switch (screen print key) or from the PC. On completion of printing the bit is set back to “0” (OFF). Note that if the NT620S/620C system menu or an error screen is displayed, the bit will be set to “0” (OFF) even if the printer is printing.

For details, see “NT620S/620C Status Control” (page 257).

## 5-8-2 Reading the NT620S/620C Operating Statuses

This section explains how to determine the status of the NT620S/620C, and ascertain its operating status.

- Restrictions on allocating words

The PT status notify area (PT → PC) can be allocated to the PC memory areas listed in the following table.

Symbol	C Series PCs	Allocated	CVM1/CV Series PCs	Allocated
DM	Data memory	✓	Data memory	✓
CH	Internal/Special Relay	✓	Internal/Special Relay	✓
TIM	Timer	×	Timer	×
CNT	Counter	×	Counter	×
HR	Holding Relay	✓	–	
AR	Auxiliary Relay	✓	Auxiliary Relay	×
LR	Link Relay	✓	–	

✓: OK    ×: NG

Since all the CVM1/CV-series special auxiliary relays are allocated to the system, they cannot be used for applications not related to the system.

The range of each memory area differs according to the PC type. See Appendix L “PC Memory Map” (page 354).

- Procedure**
1. Use the support tool to allocate the PT status notify area (PT → PC) to the PC memory.
  2. Write a PC program to read the “PT status” word of the PT status notify area and check each bit status.
- Report timing of PT status notify bit

The information in the PC status notify area (PT → PC) is written to the PC when the NT620S/620C status is changed during operation.

**Example of Using the PT Status Notify Bit**

An operation example in which the NT620S/620C status is checked by operating the PT status notify bit is explained below.

- Support tool settings

Perform the following setting with the support tool.

PT status notify area allocated word: CH0110

- PC program

Create the following PC ladder program.

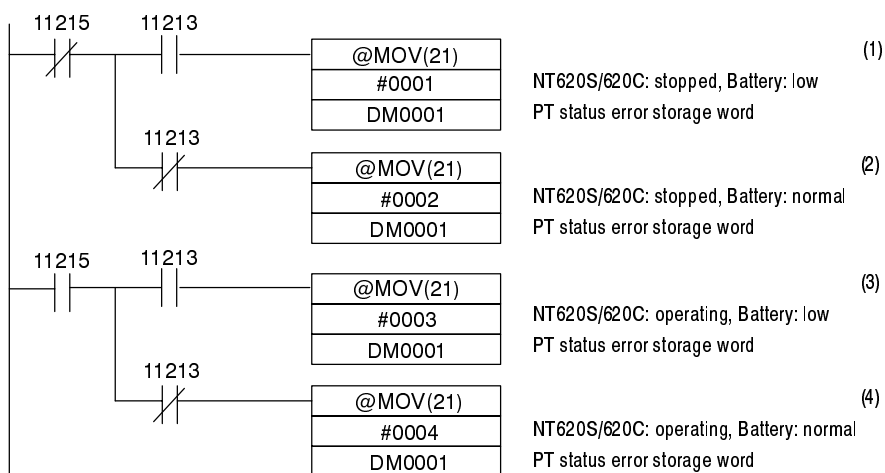

- Program operation
  - (1) If PT operating status (contact 11215) is turned OFF (0) and battery (contact 11213) is turned ON (1), “1” (NT620S/620C stop, low battery voltage) is transmitted to DM0001.
  - (2) If PT operating status (contact 11215) is turned OFF (0) and battery (contact 11213) is turned OFF (0), “2” (NT620S/620C stop, normal battery voltage) is transmitted to DM0001.
  - (3) If PT operating status (contact 11215) is turned ON (1) and battery (contact 11213) is turned ON (1), “3” (NT620S/620C running, low battery voltage) is transmitted to DM0001.
  - (4) If PT operating status (contact 11215) is turned ON (1) and battery (contact 11213) is turned OFF (0), “4” (NT620S/620C running, normal battery voltage) is transmitted to DM0001.



---

# SECTION 6

## Using Memory Link

This section gives an overview of memory link operations and contains explanations centered on communications between the NT620S/NT620C and host when using the memory link.

- 6-1 Operation of the Memory Link ..... 268
  - 6-1-1 What is the Memory Link? ..... 268
  - 6-1-2 PT Memory ..... 269
  - 6-1-3 Memory Link Commands ..... 269
- 6-2 Outline of Communications ..... 271
  - 6-2-1 Communication Protocol ..... 271
  - 6-2-2 Notes on Using Commands ..... 272
- 6-3 Commands/Responses ..... 275

## 6-1 Operation of the Memory Link

This section describes the function of the memory link.

### 6-1-1 What is the Memory Link?

The memory link is a new communication method which allows use of the direct connection function from a host with RS-232C or RS-422A communications.

In ordinary direct connection, each of the display elements of the NT620S/NT620C is allocated to the PC memory of the host. In contrast, when using the memory link, the NT620S/NT620C has an area in its memory called the "PT memory" and direct connection is executed with respect to this area, treating it as though it were a memory area in a PC.

By issuing memory link commands when necessary, the host can read and write the contents of the PT memory and the contents of NT620S/NT620C memory tables. Also, when touch switches are pressed or numeric values or character strings are input at the NT620S/NT620C side, the NT620S/NT620C issues a command to notify this input to the host.

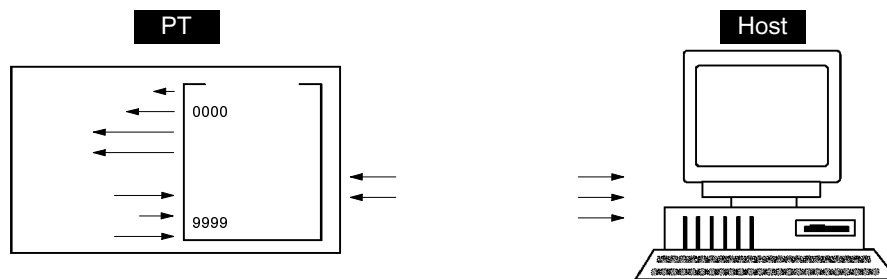

Therefore "memory link" is virtual direct connection executed at the NT620S/NT620C and controlled by commands from the host. Memory link has the following restrictions when compared with host link and NT link.

- The only area that can be used for allocation is the I/O relay area (word area).

### 6-1-2 PT Memory

The PT memory is a virtual PC area within the NT620S/NT620C. However, there is no classification of the area as there is with real PC areas: it consists of an I/O relay area of just 10000 words from 0000 to 9999. Consequently, only I/O relay words can be designated as allocated words.

Memory link can be treated in exactly the same way as direct connection, except that there is no area classification. The specification of bits is also the same.

A diagram of the PT memory is shown below.

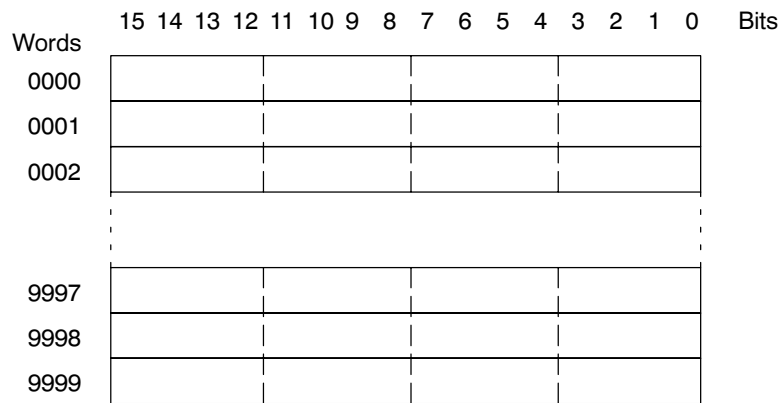

**Reference**

- The PT memory is backed up by the battery even while the NT620S/NT620C power is OFF.
- The explanations in this section concentrate on the memory link communication method. For details on control and notification between the NT620S/NT620C display elements and the PT memory, refer to Section 5 “Using Host Link/NT Link”.

### 6-1-3 Memory Link Commands

When using the memory link, data is sent and received between the host and NT620S/NT620C using commands such as those indicated below.

**Data Read Commands/Responses**

These are the commands for reading the contents of the PT memory and memory tables in the NT620S/NT620C. They are issued from the host and, as the response, the NT620S/NT620C sends back the specified data.

There are the following three commands.

- PT memory read command Page 275
- Numeral memory table read command Page 277
- Character-string memory table read command Page 279

**Data Write Commands/Responses**

These are the commands for writing data to the PT memory and memory tables in the NT620S/NT620C. They are issued from the host and, as the response, the NT620S/NT620C sends a reply indicating whether or not writing was completed normally. It is possible to omit the response when writing is successful.

There are the following six commands.

- PT memory write command Page 281
- Numeral memory table write command Page 283
- Character-string memory table write command Page 285
- PT memory batch write (FILL) command Page 286
- Numeral memory table clear command Page 287
- Character-string memory table clear command Page 288

**Notify commands**

These commands serve to notify the host of the results of operation at the NT620S/NT620C. Only these commands are issued by the NT620S/NT620C and, therefore, there is no response for them.

The following four switches are available.

- Touch switch input notify command Page 289
- Numerical input notify command Page 291
- Character string input notify command Page 292
- PT status notify command Page 293

**Re-send command**

This command lets the NT620S/NT620C re-send a notify command. It is issued from the host and the notify command issued last is re-sent from the NT620S/NT620C.

- Re-send request command Page 295

## 6-2 Outline of Communications

This section describes the basic communication protocol when using memory link and the program flow for using memory link, taking RS-232C communications using the BASIC language as an example.

### 6-2-1 Communication Protocol

Communication between the host and the NT620S/NT620C takes place in accordance with the following protocol.

- (1) In order to perform communications, it is first necessary to open the communication line. "Opening" here means making the line usable.
- (2) In accordance with the commands, the NT620S/NT620C is controlled or notification is received from the NT620S/NT620C.
- (3) To terminate communication, the communication line is closed.

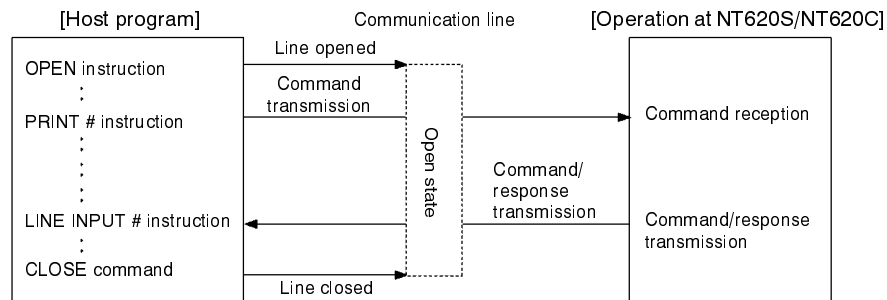

Once the line has been opened, it can be used until it is closed.

#### Function of each instruction

- OPEN instruction : Opens the RS-232C line.  
Also sets the communication conditions at the host side (see page 56).
- PRINT # instruction : Sends commands to the NT620S/NT620C via an RS-232C line.
- LINE INPUT # instruction : Receives the command or response from the NT620S/NT620C.  
In order to receive input delimited by commas and double quotation marks, use "LINE INPUT".
- CLOSE instruction : Closes the RS-232C line.

For detailed information on instructions, refer to the BASIC language instruction manual for the host.

**Operation When Using Instructions**

The flow of communications between the host and the NT620S/NT620C follows one of the three patterns indicated below, depending on the type of command and the setting made for “response” with the memory switches (see page 78).

• **Pattern with write command when “No” is set for the response**

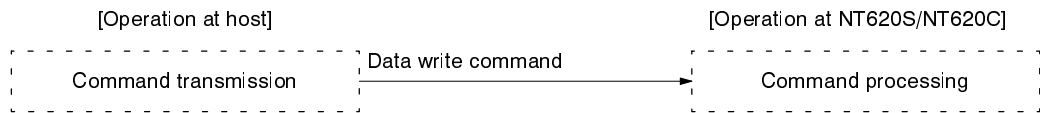

However, when an error occurs, an error response is returned.

• **Pattern with data read command, re-send command, and data write command when response “Yes” is set.**

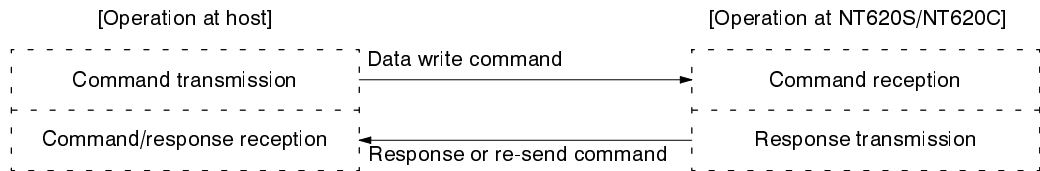

Sometimes multiple responses may be received for one command.

• **Pattern when the operation at the NT620S/NT620C is notified to the host**

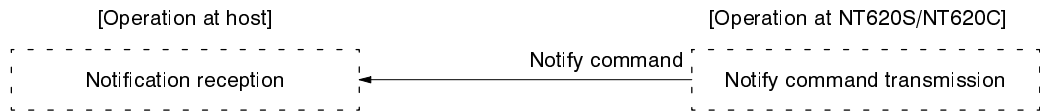

**6-2-2 Notes on Using Commands**

The points that should be observed when using commands are given below.

**Method for Specifying Commands**

When a personal computer or similar device is used as the host and a high-level language such as BASIC or C is used for program writing, commands are specified as ASCII character strings.

Note that in the explanations in this section, parameters are denoted in lower case characters. When specifying a command, write those parts denoted in upper case without modification, and write the numeric values for parameters (BCD or hexadecimal) as ASCII character strings.

Parts in square brackets, such as [ESC] and [CR] each indicate one control code (the [ESC] code, the [CR] code, etc.).

In the format, parentheses are used to indicate parts that can under some circumstances be omitted, and \*\* is used to indicate the ASCII code (two hexadecimal digits) of the specified character.

In the explanations of commands, expressions such as “4 BCD digits” and “2 hexadecimal digits” are used to mean (respectively) “the ASCII character string for a numerical value expressed as four BCD digits” and “the ASCII character string for a numerical value expressed as two hexadecimal digits”, etc. Do not specify BCD and hexadecimal data without alteration: always convert it into an ASCII character string before transmission.

[Example]

The format for the numeral value memory table read command is shown below.

[ESC]	R	N	m	t <sub>1</sub>	t <sub>2</sub>	t <sub>3</sub>	t <sub>4</sub>	
1B	52	4E	**	**	**	**	**	
	(l <sub>1</sub> )	(l <sub>2</sub> )	(s <sub>1</sub> )	(s <sub>2</sub> )	[CR]			
	**	**	**	**	0D			

The following parameters are specified in this format.

- m : 1 (1 BCD digit)
- t<sub>1</sub> t<sub>2</sub> t<sub>3</sub> t<sub>4</sub> : 0123 (4 BCD digits)
- l<sub>1</sub> l<sub>2</sub> : 99 (2 BCD digits)
- s<sub>1</sub> s<sub>2</sub> : 24 (2 hexadecimal digits)

The character string actually transmitted is as shown below.

[ESC]	R	N	1	0	1	2	3	
1B	52	4E	31	30	31	32	33	
	9	9	2	4	[CR]			
	39	39	32	34	0D			

**Reference**

In the “Format” sections in the explanations for commands/responses, parentheses are used to indicate parts that can under some circumstances be omitted, and \*\* is used to indicate the ASCII code (two hexadecimal digits) of the specified character.

**Processing differences according to command length**

- If a command is too long because it has been incorrectly specified, an error response for a command length error is returned.
- If a command is too short because it has been incorrectly specified, a communication error (time out) occurs.

**Command transmission intervals**

- If commands are sent too frequently, processing at the NT620S/NT620C will not be able to keep pace with them and a communication error (buffer overflow) will occur.
- Use the flow control to prevent a buffer overflow.

**Order of priority of input communication commands**

- When a reason for input notification arises during processing of a command from the host, the input command is issued only after the ongoing command processing has been completed.

**Check sum**

- The checksum of the command response is the lower one-byte of the total sum (in units of bytes) of the following, from the [ESC] code at the beginning to the character immediately before the checksum value.

**Reference**

---

If "ON" is set for the "Automatic Reset" memory switch, communication errors are not displayed on the screen even if they occur, with the exception of overflow errors. If an overflow error occurs, an error message is displayed on the screen and operation is stopped.

---



### 6-3 Commands/Responses

This section describes the commands used with the memory link and their responses.

PT memory read command (Sent from host to PT)

**Command**

**Format**

[ESC]	R	M	m	c <sub>1</sub>	c <sub>2</sub>	c <sub>3</sub>	c <sub>4</sub>	
1B	52	4D	**	**	**	**	**	
	(l <sub>1</sub> )	(l <sub>2</sub> )	(s <sub>1</sub> )	(s <sub>2</sub> )	[CR]			
	**	**	**	**	0D			

- m : Check sum present/absent (1 BCD digit)
  - 0 : Absent
  - 1 : Present
  - 8 : Absent (1 word read)
  - 9 : Present (1 word read)
- c<sub>1</sub> to c<sub>4</sub> : First word number read (4 BCD digits)
  - 0000 to 9999
- l<sub>1</sub>, l<sub>2</sub> : Number of read words (2 BCD digits)
  - 00 : 100 words
  - 01 to 99 : 1 to 99 words
  - When m is 8 or 9, omit this setting.
- s<sub>1</sub>, s<sub>2</sub> : Check sum (2 hexadecimal digits)
  - When m is 0 or 8, omit this setting.

Response

Format

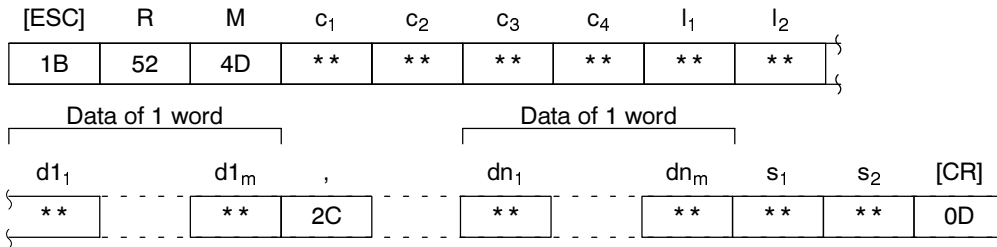

c<sub>1</sub> to c<sub>4</sub> : First word number read (4 BCD digits)  
0000 to 9999

l<sub>1</sub>, l<sub>2</sub> : Number of read words (2 BCD digits)  
01 to 50: 1 to 50 words

d<sub>1<sub>1</sub></sub> to d<sub>1<sub>m</sub></sub>, ..., dn<sub>1</sub> to dn<sub>m</sub>:  
Contents of the read words (1 to 4 hexadecimal digits)  
0 to FFFF  
Since initial zeroes are omitted, there may be less than 4 digits. Individual words of data are delimited by commas.

s<sub>1</sub>, s<sub>2</sub> : Check sum (2 hexadecimal digits)  
This is always added.

Function

- Reads the contents of the specified number of words from the specified word of the PT memory.
- Used to read the statuses of the PT status notify area, lamps, touch switches and bit memory tables allocated to the PT memory, and the contents of numeral and character string memory tables.
- A maximum of 100 words can be read at one time.
- In the response, a maximum of 50 words can be returned at one time. If reading of more than 50 words is specified, the response is split into two parts. In this case the first part always contains 50 words of data. Note also that the “first word number read” in the second part of the response will be the word number of the first word in the response data.

**Example**

Reading the PT status in the PT status notify area (allocated words: 0010 to 0012)

- Command

[ESC]	R	M	8	0	0	1	2	[CR]
1B	52	4D	38	30	30	31	32	0D

No check sum (1 word read), first word read = 0012

- Response

[ESC]	R	M	0	0	1	2	0	1	}
1B	52	4D	30	30	31	32	30	31	
	9	0	0	0	A	7	[CR]		}
	39	30	30	30	41	37	0D		

Numeral memory table read command

(Sent from host to PT)

**Command**

**Format**

[ESC]	R	N	m	t <sub>1</sub>	t <sub>2</sub>	t <sub>3</sub>	t <sub>4</sub>	}
1B	52	4E	**	**	**	**	**	
	(l <sub>1</sub> )	(l <sub>2</sub> )	(s <sub>1</sub> )	(s <sub>2</sub> )	[CR]			}
	**	**	**	**	0D			

- m : Check sum present/absent (1 BCD digit)
  - 0 : Absent
  - 1 : Present
  - 8 : Absent (only 1 table read)
  - 9 : Present (only 1 table read)
- t<sub>1</sub> to t<sub>4</sub> : First numeral memory table number read (4 BCD digits)
  - 0000 to 0999
- l<sub>1</sub>, l<sub>2</sub> : Number of read tables (2 BCD digits)
  - 00 : 100
  - 01 to 99 : 1 to 99
  - When m is 8 or 9, omit this setting.
- s<sub>1</sub>, s<sub>2</sub> : Check sum (2 hexadecimal digits)
  - When m is 0 or 8, omit this setting.

Response

Format

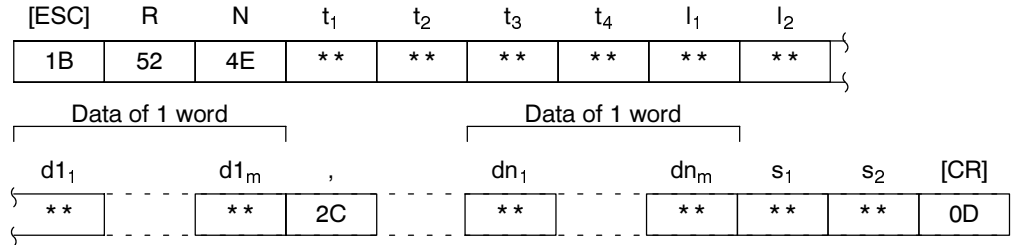

t<sub>1</sub> to t<sub>4</sub> : First numeral memory table number read (4 BCD digits)  
0000 to 0999

l<sub>1</sub>, l<sub>2</sub> : Number of read tables (2 BCD digits)  
01 to 20: 1 to 20 tables

d<sub>11</sub> to d<sub>1m</sub>, ..., dn<sub>1</sub> to dn<sub>m</sub> :  
 Contents of the numeral memory tables  
 (1 to 8 hexadecimal digits)  
 0 to FFFFFFFF  
 Since initial zeroes are omitted, there may be less than 8 digits. The data for individual tables is delimited by commas.

s<sub>1</sub>, s<sub>2</sub> : Check sum (2 hexadecimal digits)  
This is always added.

Function

- Reads the data from the specified number of numeral memory tables, starting from the specified numeral memory table.
- A maximum of 100 tables can be read at one time.
- In the response, the data of a maximum of 20 tables can be returned at one time. If reading of more than 20 tables is specified, multiple responses are made, each comprising the data of 20 tables. Note that the “first word number read” in the second and later responses will be the word number of the first word of the response data.

Character string memory table read command

(Sent from host to PT)

**Command**

**Format**

[ESC]	R	S	m	t <sub>1</sub>	t <sub>2</sub>	t <sub>3</sub>	t <sub>4</sub>		
1B	52	53	**	**	**	**	**	**	
	(l <sub>1</sub> )	(l <sub>2</sub> )	(s <sub>1</sub> )	(s <sub>2</sub> )	[CR]				
	**	**	**	**	0D				

- m : Check sum present/absent (1 BCD digit)
  - 0 : Absent
  - 1 : Present
  - 8 : Absent (only 1 table read)
  - 9 : Present (only 1 table read)
- t<sub>1</sub> to t<sub>4</sub> : First character string memory table number read (4 BCD digits)
  - 0000 to 0999
- l<sub>1</sub>, l<sub>2</sub> : Number of read tables (2 BCD digits)
  - 01 to 20 : 1 to 20
  - When m is 8 or 9, omit this setting.
- s<sub>1</sub>, s<sub>2</sub> : Check sum (2 hexadecimal digits)
  - When m is 0 or 8, omit this setting.

Response

Format

[ESC]	R	S	t <sub>1</sub>	t <sub>2</sub>	t <sub>3</sub>	t <sub>4</sub>	d1 <sub>1</sub>	d1 <sub>2</sub>	...
1B	52	53	**	**	**	**	**	**	...
			dn <sub>1</sub>	dn <sub>2</sub>	s <sub>1</sub>	s <sub>2</sub>	[CR]		
			**	**	**	**	0D		

t<sub>1</sub> to t<sub>4</sub> : First character string memory table number read (4 BCD digits)  
0000 to 0999

d1<sub>1</sub> to d1<sub>m</sub>, ..., dn<sub>1</sub> to dn<sub>m</sub> :  
Contents of the read character string memory tables (2 digits (hexadecimal) corresponding to 1 to 40 characters)  
00 to FF  
In the case of character string memory tables allocated to the host, this is the registered number of words multiplied by 2, and the case of character string memory tables not allocated to the host it is data for 40 characters.

s<sub>1</sub>, s<sub>2</sub> : Check sum (2 hexadecimal digits)  
This is always added.

Function

- Reads the data of the specified number of character string memory tables, starting from the specified character string memory table.
- A maximum of 20 tables can be read at one time.
- In the response, data is returned in units of one table at a time. If reading of multiple tables is specified, a number of responses equal to the specified number of tables is made. Note that the “read character string memory table number” is always the number of the data of the response.

PT memory write command

(Sent from host to PT)

**Command**

**Format**

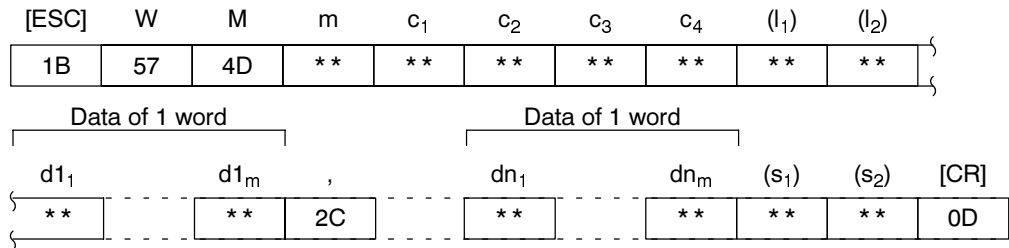

- m : Presence/absence of check sum, write attribute (1 BCD digit)

  - 0 : Absent, SET attribute
  - 1 : Present, SET attribute
  - 2 : Absent, AND attribute
  - 3 : Present, AND attribute
  - 4 : Absent, OR attribute
  - 5 : Present, OR attribute
  - 6 : Absent, XOR attribute
  - 7 : Present, XOR attribute
  - 8 : Absent, SET attribute (writing 1 word)
  - 9 : Present, SET attribute (writing 1 word)
- c<sub>1</sub> to c<sub>4</sub> : First word No. written (4 BCD digits)  
0000 to 9999
- l<sub>1</sub>, l<sub>2</sub> : Number of words written (2 BCD digits)  
01 to 50 : 1 to 50 words  
If m is 8 or 9, omit this setting.
- d<sub>1</sub><sub>1</sub> to d<sub>1</sub><sub>m</sub>, ..., dn<sub>1</sub> to dn<sub>m</sub> :  
Data of written words (1 to 4 hexadecimal digits)  
0 to FFFF  
It is possible to omit initial zeroes so that there are less than 4 digits.  
Individual words of data are delimited by commas.
- s<sub>1</sub>, s<sub>2</sub> : Check sum (2 hexadecimal digits)  
If m is an even number, omit this setting.

**Response**

Only if “Yes” is set for the “Response” memory switch, the response indicated below is returned on normal completion.

**Format**

[ESC]	W	M	0	0	s <sub>1</sub>	s <sub>2</sub>	[CR]
1B	57	4D	30	30	31	46	0D

s<sub>1</sub>, s<sub>2</sub> : Check sum (2 hexadecimal digits)  
 This is always added (fixed as “1F”).

**Function**

- Writes the data of the specified number of words starting from the specified word in the PT memory. The result after executing the specified operation (write attribute) on the present contents of the PT the PT memory and the written data is written.
- A maximum of 50 words can be written at one time.



Numeral memory table write command

(Sent from host to PT)

**Command**

**Format**

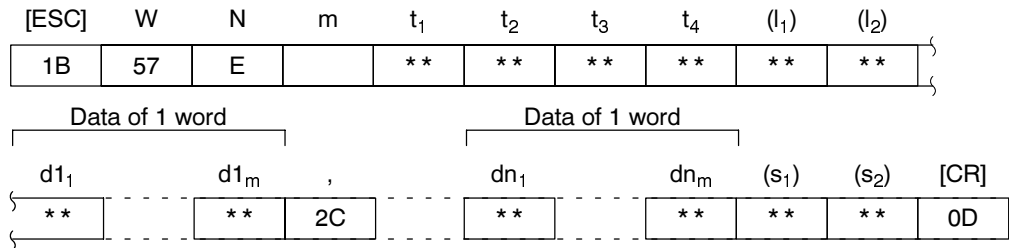

- m : Check sum present/absent (1 BCD digit)
  - 0 : Absent
  - 1 : Present
  - 8 : Absent (only 1 table written)
  - 9 : Present (only 1 table written)
  
- t<sub>1</sub> to t<sub>4</sub> : First numeral memory table number written to (4 BCD digits)
  - 0000 to 0999
  
- l<sub>1</sub>, l<sub>2</sub> : Number of written tables (2 BCD digits)
  - 01 to 20 : 1 to 20 tables
  - When m is 8 or 9, omit this setting.
  
- d<sub>1</sub><sub>1</sub> to d<sub>1</sub><sub>m</sub>, ..., d<sub>n</sub><sub>1</sub> to d<sub>n</sub><sub>m</sub> :
  - Contents of the numeral memory tables (1 to 8 hexadecimal digits)
  - 0 to FFFFFFFF
  - It is possible to omit initial zeroes so that there are less than 8 digits.
  - Individual words of data are delimited by commas.
  
- s<sub>1</sub>, s<sub>2</sub> : Check sum (2 hexadecimal digits)
  - When m is 0 or 8, omit this setting.

**Response**

Only if “Yes” is set for the “Response” memory switch, the response indicated below is returned on normal completion.

**Format**

[ESC]	W	N	0	0	s <sub>1</sub>	s <sub>2</sub>	[CR]
1B	57	4E	30	30	32	30	0D

s<sub>1</sub>, s<sub>2</sub> : Check sum (2 hexadecimal digits)  
 This is always added (fixed as “20”).

**Function**

- Writes the data of the specified number of numeral memory tables, starting from the specified numeral memory table.
- Writing from a maximum of 20 memory tables is possible at one time.

Character string memory table write command

(Sent from host to PT)

**Command**

**Format**

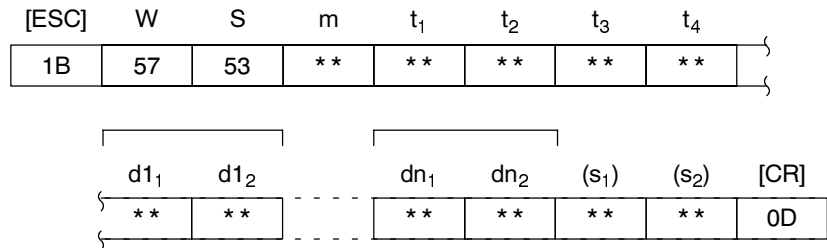

- m : Check sum present/absent (1 BCD digit)
  - 0 : Absent
  - 1 : Present
- t<sub>1</sub> to t<sub>4</sub> : Character string memory table number written to (4 BCD digits)
  - 0000 to 0255
- d<sub>1</sub><sub>1</sub> to d<sub>1</sub><sub>2</sub>, ..., dn<sub>1</sub> to dn<sub>2</sub> :
  - Contents of the read character string memory tables (2 digits (hexadecimal) corresponding to 1 to 40 characters)
  - 00 to FF
  - In the case of character string memory tables allocated to the host, specify the registered number of words multiplied by 2, and in the case of character string memory tables not allocated to the host specify the data for 40 characters.
- s<sub>1</sub>, s<sub>2</sub> : Check sum (2 hexadecimal digits)
  - When m is 0 or 8, omit this setting.

**Response**

Only if "Yes" is set for the "Response" memory switch, the response indicated below is returned on normal completion.

**Format**

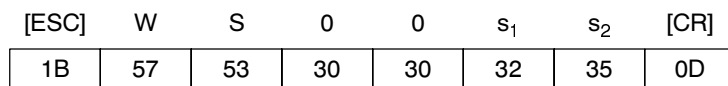

- s<sub>1</sub>, s<sub>2</sub> : Check sum (2 hexadecimal digits)
  - This is always added (fixed as "25").

**Function**

- Writes specified data to the specified character string memory tables.

PT memory batch write (FILL) command

(Sent from host to PT)

**Command**

**Format**

[ESC]	F	M	m	b <sub>1</sub>	b <sub>2</sub>	b <sub>3</sub>	b <sub>4</sub>	e <sub>1</sub>	e <sub>2</sub>	
1B	46	4D	**	**	**	**	**	**	**	
	e <sub>3</sub>	e <sub>4</sub>	d <sub>1</sub>		d <sub>m</sub>	(s <sub>1</sub> )	(s <sub>2</sub> )	[CR]		
	**	**	**		**	**	**	0D		

- m : Check sum present/absent (1 BCD digit)  
0 : Absent  
1 : Present
- b<sub>1</sub> to b<sub>4</sub> : First written word number (4 BCD digits)  
0000 to 9999
- e<sub>1</sub> to e<sub>4</sub> : Final written word number (4 BCD digits)  
0000 to 9999
- d<sub>1</sub> to d<sub>m</sub> : Data to be written (1 to 4 hexadecimal digits)  
0 to FFFF  
It is possible to omit initial zeroes so that there are less than 4 digits.
- s<sub>1</sub>, s<sub>2</sub> : Check sum (2 hexadecimal digits)  
If m is 0, omit this setting.

**Response**

Only if “Yes” is set for the “Response” memory switch, the response indicated below is returned on normal completion.

**Format**

[ESC]	F	M	0	0	s <sub>1</sub>	s <sub>2</sub>	[CR]
1B	46	4D	30	30	30	45	0D

- s<sub>1</sub>, s<sub>2</sub> : Check sum (2 hexadecimal digits)  
This is always added (fixed as “0E”).

**Function**

- Writes the specified data to all the words within the range specified by the “first written word number” and “final written word number”.

Numeral memory table clear command

(Sent from host to PT)

**Command**

**Format**

[ESC]	C	N	m	(b <sub>1</sub> )	(b <sub>2</sub> )	(b <sub>3</sub> )	(b <sub>4</sub> )	}
1B	43	4E	**	**	**	**	**	
	(e <sub>1</sub> )	(e <sub>2</sub> )	(e <sub>3</sub> )	(e <sub>4</sub> )	(s <sub>1</sub> )	(s <sub>2</sub> )	[CR]	}
	**	**	**	**	**	**	0D	

- m : Check sum present/absent (1 BCD digit)  
 0 : Absent  
 1 : Present
- b<sub>1</sub> to b<sub>4</sub> : First cleared numeral memory table number  
 (4 BCD digits)  
 0000 to 9999
- e<sub>1</sub> to e<sub>4</sub> : Final cleared numeral memory table number  
 (4 BCD digits)  
 0000 to 9999
- s<sub>1</sub>, s<sub>2</sub> : Check sum (2 hexadecimal digits)  
 If m is 0, omit this setting.

**Response**

Only if “Yes” is set for the “Response” memory switch, the response indicated below is returned on normal completion.

**Format**

[ESC]	C	N	0	0	s <sub>1</sub>	s <sub>2</sub>	[CR]
1B	43	4E	30	30	30	43	0D

- s<sub>1</sub>, s<sub>2</sub> : Check sum (2 hexadecimal digits)  
 This is always added (fixed as “0C”).

**Function**

- Initializes all the numeral memory tables within the range specified by the “first cleared numeral memory table number” and “final cleared numeral memory table number” to the value set with the support tool.
- If settings are omitted for both the “first cleared numeral memory table number” and the “final cleared numeral memory table number”, all the numeral memory tables are cleared. It is not possible to omit just one of these settings.

Character string memory table clear command

(Sent from host to PT)

**Command**

**Format**

[ESC]	C	S	m	(b <sub>1</sub> )	(b <sub>2</sub> )	(b <sub>3</sub> )	(b <sub>4</sub> )	}
1B	43	53	**	**	**	**	**	
	(e <sub>1</sub> )	(e <sub>2</sub> )	(e <sub>3</sub> )	(e <sub>4</sub> )	(s <sub>1</sub> )	(s <sub>2</sub> )	[CR]	}
	**	**	**	**	**	**	0D	

- m : Check sum present/absent (1 BCD digit)  
 0 : Absent  
 1 : Present
- b<sub>1</sub> to b<sub>4</sub> : First cleared character string memory table number  
 (4 BCD digits)  
 0000 to 0255
- e<sub>1</sub> to e<sub>4</sub> : Final cleared character string memory table number  
 (4 BCD digits)  
 0000 to 0255
- s<sub>1</sub>, s<sub>2</sub> : Check sum (2 hexadecimal digits)  
 If m is 0, omit this setting.

**Response**

Only if “Yes” is set for the “Response” memory switch, the response indicated below is returned on normal completion.

**Format**

[ESC]	C	S	0	0	s <sub>1</sub>	s <sub>2</sub>	[CR]
1B	43	53	30	30	31	31	0D

- s<sub>1</sub>, s<sub>2</sub> : Check sum (2 hexadecimal digits)  
 This is always added (fixed as “11”).

**Function**

- Initializes all the character string memory tables within the range specified by the “first cleared character string memory table number” and “final cleared character string memory table number” to the value set with the support tool.
- If settings are omitted for both the “first cleared character string memory table number” and the “final cleared character string memory table number”, all the character string memory tables are cleared. It is not possible to omit just one of these settings.

Touch switch input notify command

(Sent from PT to host)

**Command**

**Format**

[ESC]	S	T	c <sub>1</sub>	c <sub>2</sub>	c <sub>3</sub>	c <sub>4</sub>	d <sub>1</sub>	d <sub>2</sub>	
1B	53	54	**	**	**	**	**	**	}
	d <sub>3</sub>	d <sub>4</sub>	a <sub>1</sub>	a <sub>2</sub>	a <sub>3</sub>	a <sub>4</sub>	s <sub>1</sub>	s <sub>2</sub>	[CR]
	**	**	**	**	**	**	**	**	0D

- c<sub>1</sub> to c<sub>4</sub> : Changed word number (4 BCD digits)  
0000 to 9999  
This is the number of the word containing the allocated bit of the touch switch at which there has been a change.
- d<sub>1</sub> to d<sub>4</sub> : Contents of the word after the change  
(4 hexadecimal digits)  
0000 to FFFF
- a<sub>1</sub> to a<sub>4</sub> : Changed bit information (4 hexadecimal digits)  
0000 to FFFF  
The changed bit in the “contents of the word after the change” is set to “1”.
- s<sub>1</sub>, s<sub>2</sub> : Check sum (2 hexadecimal digits)  
This is always added.

**Response**

**Format**

None

**Function**

- When the status of a touch switch changes because it has been touched or released, notifies the change of status to the host.
- Normally, one command notifies the change in status of one allocated bit only, but when multiple bits in the same word change simultaneously, these changes are all notified together with one command.

**Reference**

When the screen is switched after pressing a “momentary” key, this command goes OFF.  
The change is also notified to the host.

Example

- Command

[ESC]	S	T	0	1	0	2	3	0	}
1B	53	54	30	31	30	32	33	30	
	1	3	0	0	0	1	0	D	[CR]
	31	33	30	30	30	31	30	44	0D

Changed word number : 0102CH

Contents of the word after the change (hexadecimal) :  
 3013 (binary notation: 0011 0000 0001 0011)

Changed bit information (hexadecimal) :  
 0001 (binary notation: 0000 0000 0000 0001)

Check sum (hexadecimal) : 0D

From the “changed word number” and “changed bit information”, it is ascertained that the change relates to the touch switch allocated to bit 00 of word 0102CH, and because “1” is set at the relevant position in the “contents of the word after the change”, it is ascertained that the touch switch has been pressed (if the change is to “OFF”, since the operation differs according to the type of touch switch, it cannot be determined from a change in the bit status alone whether the touch switch has been touched or released).



Numerical input notify command

(Sent from PT to host)

**Command**

**Format**

[ESC]	S	N	t <sub>1</sub>	t <sub>2</sub>	t <sub>3</sub>	t <sub>4</sub>	d <sub>1</sub>	d <sub>2</sub>	
1B	53	4E	**	**	**	**	**	**	
	d <sub>3</sub>	d <sub>4</sub>	d <sub>5</sub>	d <sub>6</sub>	d <sub>7</sub>	d <sub>8</sub>	s <sub>1</sub>	s <sub>2</sub>	[CR]
	**	**	**	**	**	**	**	**	0D

- t<sub>1</sub> to t<sub>4</sub> : Input numeral memory table number (4 BCD digits) 0000 to 0999  
This is the number of the numeral memory table for which there has been numerical input.
- d<sub>1</sub> to d<sub>8</sub> : Input numeric data (8 hexadecimal digits) 00000000 to FFFFFFFF
- s<sub>1</sub>, s<sub>2</sub> : Check sum (2 hexadecimal digits)  
This is always added.

**Response**

**Format**

None

**Function**

- In accordance with operations at the PT, such as numeral settings and copying of memory tables, notifies the host that a numeric value has been input to the numeral memory table.

**Example**

- Command

[ESC]	S	N	0	1	5	0	0	0	
1B	53	4E	30	31	35	30	30	30	
	0	3	0	0	0	0	0	5	[CR]
	30	33	30	30	30	30	30	35	0D

- Input numeral memory table number : No. 150
- Input numeric value data (hexadecimal) : 30000
- Check sum (hexadecimal) : 05

Here, it is ascertained that 30000 has been input to numeral memory table No. 150 (whether this is 30000 in hexadecimal or 30000 in BCD is determined on the basis of the input conditions).

Character string input notify command

(Sent from PT to host)

**Command**

**Format**

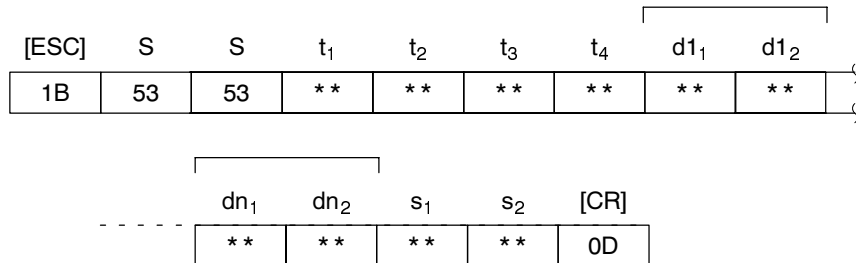

t<sub>1</sub> to t<sub>4</sub> : Input character string memory table number (4 BCD digits) 0000 to 0255  
This is the number of the character string memory table for which there has been character string input.

d<sub>1</sub><sub>1</sub>, d<sub>1</sub><sub>2</sub>, ..., dn<sub>1</sub>, dn<sub>2</sub> : Contents of the read character string memory tables (2 digits (hexadecimal) corresponding to 1 to 40 characters) 00 to FF  
In the case of character string memory tables allocated to the host, this is the registered number of words multiplied by 2, and the case of character string memory tables not allocated to the host it is data for 40 characters.

s<sub>1</sub>, s<sub>2</sub> : Check sum (2 hexadecimal digits)  
This is always added.

**Response**

**Format**

None

**Function**

- In accordance with operations at the PT, such as character string settings and copying of character string memory tables, notifies the host that a character string has been input to the character string memory table.

Example

- Command

[ESC]	s	s	0	2	1	0	O	M	
1B	53	53	30	32	31	30	4F	4D	
	R	O	N	7	9	[CR]			
	52	4F	4E	37	39	0D			

Input character string memory table number : No. 210  
 Input character string data (hexadecimal) : OMRON  
 Check sum (hexadecimal) : 79

Here, it is ascertained that OMRON has been input to character string memory table No. 210.

PT status notify command (Sent from PT to host)

Command

Format

[ESC]	P	M	c <sub>1</sub>	c <sub>2</sub>	c <sub>3</sub>	c <sub>4</sub>	l <sub>1</sub>	l <sub>2</sub>	
1B	50	4D		**	**	**	**	**	
Data of 1 word			Data of 1 word						
d <sub>1<sub>1</sub></sub>	d <sub>1<sub>m</sub></sub>			d <sub>3<sub>1</sub></sub>	d <sub>3<sub>m</sub></sub>		s <sub>1</sub>	s <sub>2</sub>	[CR]
**	**		2C	**	**		**	**	0D

- c<sub>1</sub> to c<sub>4</sub> : First word number of PT status notify area (4 BCD digits)  
0000 to 9997
- l<sub>1</sub>, l<sub>2</sub> : Number of words in PT status notify area (2 BCD digits)  
Fixed as 03 (3 words).
- d<sub>1<sub>1</sub></sub> to d<sub>1<sub>m</sub></sub>, ..., d<sub>3<sub>1</sub></sub> to d<sub>3<sub>m</sub></sub> :  
Contents of the 3 words of the PT status notify area (1 to 4 hexadecimal digits)  
0 to FFFF  
Since initial zeroes are omitted, there may be less than 8 digits. Individual words of data are delimited by commas.
- s<sub>1</sub>, s<sub>2</sub> : Check sum (2 hexadecimal digits)  
This is always added.

Response

**Format**

None

**Function**

- Notifies to the host the fact that there has been a change in the status of the PT and the contents of the PT status notify area have changed. However, in the following cases a dedicated command is issued and therefore the PT status notify command is not issued.

When numeral input has occurred

When character string input has occurred

- Note also that the PT status notify command is not issued when the screen switching strobe, the numeral setting strobe or the character string setting strobe changes to ON or OFF.

Example

- Command

[ESC]	P	M	0	1	0	0	0	3	
1B	53	53	30	31	30	30	30	33	}
	0	0	3	1	0	0	0	0	}
	30	30	33	31	30	30	30	30	}
	9	0	0	0	2	9	[CR]		}
	39	30	30	30	32	39	0D		}

First word number of PT status notify area : No. 100

Number of words in PT status notify area (2 BCD digits) : 3 CH

Contents of the PT status notify area (hexadecimal) :  
 0031 (word 100, screen No. being displayed)  
 0000 (word 101, No. of memory table whose contents have changed)  
 9000 (word 102, PT status)

Check sum (hexadecimal) : 29

From the fact that bit 15 (PT operating status) and bit 12 (screen switching strobe) of the PT status have come ON it is ascertained that the screen has switched, and from the "screen No. being displayed" it is ascertained that screen No. 31 is being displayed (for details on the PT status notify area, see page 205).

Re-send request command

(Sent from host to PT)

**Command**

**Format**

[ESC]	R	R	m	(s <sub>1</sub> )	(s <sub>2</sub> )	[CR]
1B	52	52	**	**	**	0D

- m : Check sum present/absent (1 BCD digit)  
0: Absent  
1: Present
- s<sub>1</sub>, s<sub>2</sub> : Check sum (2 hexadecimal digits)  
If m is 0, omit this setting.

**Response**

**Format**

None

The input notify command last sent from the PT is re-sent.

**Function**

- Requests re-issue of the last input notify command (touch switch input notification, numeral input notification, character string input notification, PT status notification command) issued by the PT. The PT re-sends the last issued input notify command.
- The PT records the last issued input notify command. However, when the power is switched OFF or operation stopped, the information of the input notify command issued last is cleared. In this case, the command re-send request error is returned in an error response.

Error response

(Sent from PT to host)

**Response**

**Format**

[ESC]	E	R	c <sub>1</sub>	c <sub>2</sub>	s <sub>1</sub>	s <sub>2</sub>	[CR]
1B	45	52	**	**	**	**	0D

c<sub>1</sub>, c<sub>2</sub> : Error code (2 BCD digits)

- 01 : Invalid command  
A non-existent command has been used.
- 02 : Command length error  
The command length differs from the stipulated length.
- 03 : Range error  
The word/table number is outside the setting range.
- 04 : Check sum present/absent specification error  
A value other than those stipulated has been set for the check sum present/absent specification.
- 05 : Format error  
A format other than that stipulated has been used, for example the word number has been specified with 5 digits or a character code outside the permissible range has been used.
- 06 : Re-send request error  
A re-send request command has been issued although there is no input notify command to re-send.
- 10 : Check sum error  
The specified sum value and calculated sum value differ.
- 11 : Communication error  
A parity error, overrun error, or framing error has occurred. (This error code is only issued when DIP switch 4 “automatic reset on occurrence of communication error” is set to OFF.)

s<sub>1</sub>, s<sub>2</sub> : Check sum (2 hexadecimal digits)  
This is always added.

**Function**

- If there is an error in a command received by the PT, an error code is notified to the host. The command in which the error occurred is invalidated.

---

## SECTION 7

# Troubleshooting and Maintenance

This section describes the action to take when NT620S/620C errors occur, and how to carry out maintenance and inspections to prevent the occurrence of errors.

7-1	Hardware Faults .....	298
7-2	Responding to Displayed Error Messages .....	300
7-2-1	Errors Occurring when the Power is Turned ON .....	300
7-2-2	Errors Occurring During Operation .....	301
7-2-3	Errors Occurring on Screen Data Initialization and Transfer .....	301
7-2-4	Communication Errors .....	302
7-3	Maintenance of the NT620S/620C .....	304
7-3-1	Replacing the Backlight .....	304
7-3-2	Replacing the Battery .....	307
7-4	Inspection and Cleaning .....	310

## 7-1 Hardware Faults

When a fault relating to the operation of the NT620S/620C occurs, find the symptoms in the table below and respond by following the corresponding "Remedy" indicated in the table.



### Caution

- Confirm system safety before turning the power ON/OFF or resetting. Otherwise the system may operate unpredictably.
- Do not disassemble the NT620S/620C for repairs or modification. Otherwise, the product may malfunction.

NT620S/620C Symptoms	Cause	Remedy
POWER LED fails to come ON	Power is not being supplied.	Check the connections and make sure that power is supplied correctly. (Refer to 2-2-2 "Power Supply Connection", page 27.)
	Power supply fuse has blown	Contact your OMRON service center.
Nothing is displayed on the screen (it is completely white/LCD or black/EL).	Screen No. 0 has been read at the PC side.	This is not an error. Change the screen number. (Refer to 4-3 "Screen Display", page 135.)
Communication with the support tool not possible.	The Transmit Mode has not been established.	Display the system menu and select the Transmit Mode. (Refer to 3-6 "Registering the Screen Data", page 80.)
	Not connected to the support tool.	Check the installation of the connector cable. (Refer to 2-3 "Connecting to the Support Tool", page 29.)
	PT model setting and direct access setting at the support tool do not match the NT620/620C.	Using the "Tool Settings" of the support tool, set the PT model and direct access settings that match the NT620/620C.
Cannot communicate with the PC.	Memory switch settings do not match.	Check the communication setting in the "Memory Switch" menu of the Maintenance Mode, and match the PC and NT620S/620C settings. (Refer to 3-5 "Setting the Conditions of Communications with the PC by Using the Memory Switches", page 72.)
	NT620S/620C and PC are not correctly connected.	Check that the type, length and installation of the connector cable match the specifications. (Refer to 2-5 "Connection to a PC by the Host Link", page 32, and 2-6 "Connection to a PC by the NT Link", page 44.)
	In a host link connection, the PC termination resistance setting is incorrect.	Set the PC termination resistance correctly.
	In an NT link (1:N) connection, there is duplication of unit numbers.	Make the unit number settings again so that there is no duplication. Refer to "Setting Unit Numbers (NT Link 1:N Only)" (page 77).
The buzzer sounds and the RUN LED goes off.	Misoperation due to external noise.	Disconnect the communication cable from the source of the noise and insert a noise filter in the power supply line.
Touch panel does not react.	Misoperation due to external noise.	Disconnect the communication cable from the source of the noise and insert a noise filter in the power supply line.
	The touch panel is broken.	Test the touch panel using "I/O CHECK" in the maintenance mode.



NT620S/620C Symptoms	Cause	Remedy
The PC mode changes to the monitor mode.	In host link communications, the NT620S/NT620C changes mode.	This is a specification of the NT620S/NT620C. If using a PC that can also be connected via the NT link, connect it in an NT link connection (with NT link, the mode is not changed).
Graph displays are not updated.	One of the values specified for percentage displays (-100%, 0%, or 100%) is incorrect.	Set the percentage values again so that they conform with the following relationship: -100% value < 0% value < 100% value

## 7-2 Responding to Displayed Error Messages

When the NT620S/620C displays an error message, find the corresponding symptoms in the appropriate table below and respond by following the “Remedy” indicated in the table.

### 7-2-1 Errors Occurring when the Power is Turned ON

The table below shows the errors that can occur when the power supply to the NT620S/620C is turned ON, and their remedies.

Message	Cause	Remedy
Memory Unformatted	The power was switched off during initialization of the screen data memory or while checking the screen data memory.	Initialize the screen data memory and transmit the screen data again.
Screen Data Corrupted	The power was switched off during screen data transmission.	Initialize the screen data memory and transmit the screen data again.
Mark Data Corrupted	<ul style="list-style-type: none"> <li>The power was switched off during screen data transmission.</li> <li>Transmission of screen data was interrupted.</li> </ul>	Initialize the screen data memory and transmit the screen data again.
No direct information is set!! Use the Support Tool to set PT Control Area and PT Notify Area.	No words have been allocated for the PT status control area and PT status notify area.	Allocate words for the PT status control area and PT status notify area by using the support tool.
None (NT620S/NT620C doesn't start up.)	Illegal data has been written to the screen data memory.	Initialize the screen data memory. See 3-4 “Initializing Memory” (page 65).
None (The buzzer sounds and the RUN LED lights in red and orange by turns.)	The system program cannot be started up because there is an error in it.	Contact your OMRON service center.
Battery Lowered (At the same time, the RUN LED is lit in orange (during operation) or in red (when stopped).)	Voltage of battery in the NT620S/620C is low.	Change the battery. See “Replacing the Battery” (page 307).
When installing the system program, if a system program which does not display English is erased, English will not be displayed.	DIP switch SW2-2 on the NT620S/620C is OFF.	Switch off the power to the NT620S/620C, set DIP switch SW2-2 to ON, and switch the power back on.
Erase System Program Are you Sure?	DIP switch 8 of the NT620S/NT620C is set to “ON”.	After selecting “No”, switch the power to the NT620S/NT620C off, set DIP switch 8 to OFF, then switch the power back on. Do not select “Yes” except when installing the system program.
System Program Corrupted	The system program cannot be started up because there is an error in it.	Install the system program by using the NT series system installer (NT-ZS3AT).
System Program is Not Downloaded	The system program cannot be started up because it has been deleted.	Install the system program by using the NT series system installer (NT-ZS3AT).

**7-2-2 Errors Occurring During Operation**

The table below shows the errors that can occur during operation of the NT620S/620C, and their remedies.

Message	Cause	Remedy
<b>Setting Error</b> The word type and word address are displayed.	Allocated bits/words set with the support tool not found at PC.	After checking the PC area being used, set correct bits/words.
<b>Word Address Setting Error</b> Word Area of Screen data or PT Control Area is wrong. Please confirm Screen Data.		

**7-2-3 Errors Occurring on Screen Data Initialization and Transfer**

The table below shows the errors that can occur when data is written to the NT620S/620C screen data memory, and their remedies.

Message	Cause	Remedy
<b>Initialization Error</b>	Hardware fault or screen data memory life reached	If the same message is displayed even after executing screen data memory initialization or screen data transmission several times, contact your OMRON service center.

### 7-2-4 Communication Errors

This section describes the errors relating to communication with the PC that can occur during operation, and their remedies.

- Operation when a communication error occurs

When a communication error occurs, the error message is displayed at the NT620S/620C, and the buzzer sounds. Error messages are displayed when the “Automatic Reset” memory switch is not set (OFF).

**Note**

Some error messages are displayed even if the “Automatic Reset” memory switch is set (ON).

- Procedure when a communication error occurs

When an error message is displayed, press the [Confirm] touch switch displayed on the screen. The screen display will return to the RUN mode.

- Display of communication errors

As shown below, communication errors are displayed in the center of the screen, together with a classification indicating whether they are receive or send errors.

**[Screen when an error has occurred during reception]**

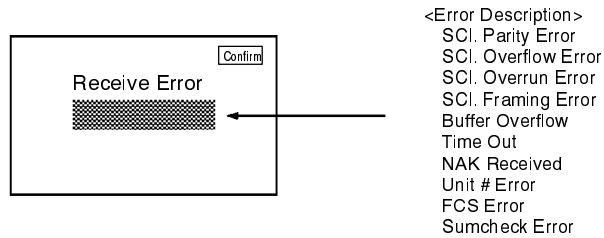

**[Screen when an error has occurred during sending]**

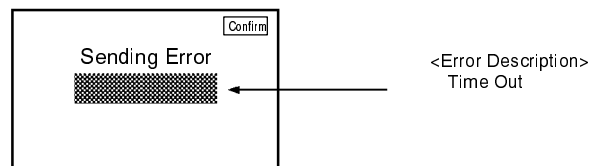

Message	Cause	Remedy
(SCI) Parity Error	Communication parameters set incorrectly.	Check whether the parity bit, data bit length, baud rate, stop bit length, and flow control settings of the PC match the settings of the NT620S/620C.
Framing Error	Noise caused data corruption during communication.	Use a noise-resistant cable if communication occurs in an environment with high levels of noise.
Overrun Error	The connectors of the connecting cable are not connected correctly.	Check the cable connection.
Overflow Error		
Buffer Overflow		
Time Out	The connectors of the connecting cable have become disconnected.	Check the cable connection.
	The PC is stopped.	Make sure the PC is able to communicate with the NT620S/620C.
	During transmission of one command, a time lapse exceeding 5 seconds is detected.	Check the cable connection.
NAK Received (end code simultaneously displayed)	Noise caused data corruption during communication.	Use a noise-resistant cable if communication occurs in an environment with high levels of noise. Check the end code by referring to the PC user's manual.
Unit No. Error	The unit No. does not match that set on the PC.	Set the PC unit No. to "0".
	The PC is transmitting incorrect data.	Check PC operation.
	Noise caused data corruption during communication.	Use a noise-resistant cable if communication occurs in an environment with high levels of noise.
FCS Error Sumcheck Error	The PC is transmitting incorrect data.	Check PC operation.
	Noise caused data corruption during communication.	Use a noise-resistant cable if communication occurs in an environment with high levels of noise.

## 7-3 Maintenance of the NT620S/620C

Carry out maintenance work in order to ensure that the NT620S/620C is always used in its optimum condition.

 **WARNING** Do not disassemble the unit or touch parts inside while the power is ON. You could sustain an electric shock.

- Spare PT

It is advisable to have a spare NT620S/620C available to minimize system downtime in the event of an NT620S/620C failure or if the screen display becomes difficult to read due to deterioration of the display unit.

### 7-3-1 Replacing the Backlight

When the backlight in the display is getting dim and the screen cannot be read easily, replace the backlight. The backlight can be replaced at the rear of the NT620C while it is mounted in an operation panel.

---

**Reference** There is no backlight in the NT620S.

---

- Replaceable backlight model  
NT620C-CFL01
- Guide to backlight replacement

Under normal conditions it can be assumed that the backlight will need to be replaced after about 20,000 hours. However, the life of the backlight does vary in accordance with the environment in which it is used and it should be replaced when it is getting dim and the screen is getting hard to read.

**Backlight Replacing Method**

Follow the procedure below to replace the backlight.

**⚠ WARNING** Turn the backlight off before replacing it. Otherwise you could sustain an electric shock.

- Operation** 1. Turn off the power to the NT620C and remove the lid of the CFL case, located at the upper right part of the rear of the NT620C: remove the screw with a Philips head screwdriver, then open the CFL case lid.

Pull the side of the CFL lid that had the screw in it toward you and pull it out at an angle.

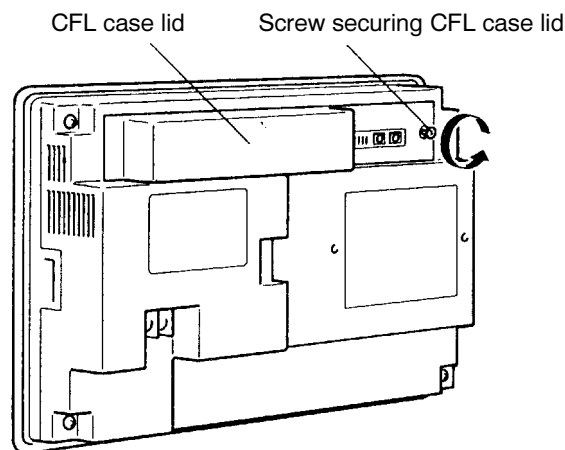

2. While lightly pressing down on the projection on the upper part of the backlight connector, pull the connector toward you to remove it from the NT620C body. While doing this, be careful not to put excessive strain on the backlight cord.

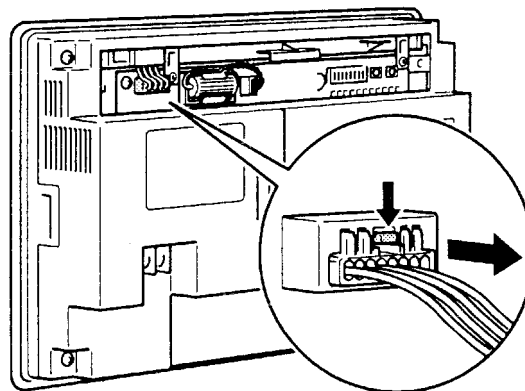

3. Remove the screws that secure the backlight with a Philips head screwdriver, grip the handle, and pull the backlight out (note that the screws are designed not to come out of the backlight). As shown in the figure below, the backlight can be removed easily if it is pulled straight out to begin with and then at a downward angle.

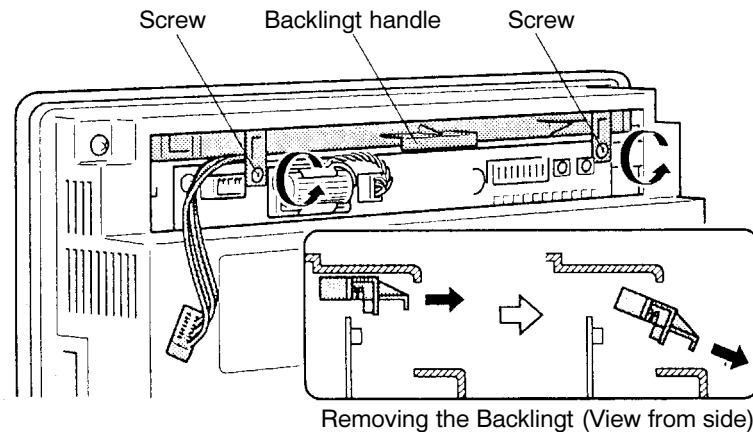

4. Insert the new backlight. Reversing the action in step 3, push the backlight in at an angle to start with, then, when it contacts something solid, continue by pushing it in straight. Now make sure that the positions of the screws that secure the backlight coincide with the positions of the screw holes in the top of the NT620C PCB.

The backlight has been inserted correctly if it fits snugly in the gap above the PCB inside the NT620C.

5. After inserting the backlight, secure it well by replacing the screws with a Philips head screwdriver.
6. Engage the backlight connector with the NT620C connector, ensuring that the projection on the backlight connector is uppermost. Insert it fully home and then check that it will not come out if pulled lightly.
7. Fit the CFL case lid and secure it with the screw.

First engage the protrusion at the left end of the lid with the opening in the NT620C, then close the lid while keeping them engaged. Be careful not to trap the backlight cord when closing the lid.

8. Switch the power ON and confirm that operation is correct when the tests on the items indicated below are performed under I/O CHECK in the maintenance mode. Also carry out a test to check communication with the host.
  - Touch switches
  - Backlight
9. Provided correct operation is confirmed in all of the tests in (8) above, start operation.



**CAUTIONS WHEN REPLACING THE BACKLIGHT**

When replacing the backlight (CFL unit), observe the following precautions.

1. Carry out the replacement work at a location where there is no possibility that dust or foreign matter will enter the unit, or that water droplets will get onto it. Discharge static electricity from your body before starting the replacement procedure.
2. The optimum tightening torque for securing the CFL unit is 0.1 N·m. That for the rear case is 0.4 N·m, and that for the terminal block and cables is 0.5 N·m.

## 7-3-2 Replacing the Battery

The NT620S/620C uses a lithium battery to back up the memory contents.

The battery life is 5 years if the NT620S/620C is used in a location where the ambient temperature is 25°C. If the temperature at the location of use is higher than this, the battery life will be shorter. Change the battery at suitable intervals in accordance with the operating environment of the NT620S/620C.

It is advisable to keep a spare battery so that the battery can be replaced immediately if replacement becomes necessary.

- Battery type

C500-BAT08

- Battery replacement clues

Replace the battery in the following cases. The battery must be replaced within 5 days.

- When 5 years have passed since the installation of a new battery.
- When the RUN LED is lit in orange (during operation) or in red (when stopped).
- When the “Battery Lowered” message is displayed on switching on the power or resetting the NT620S/620C.
- When “Battery Lowered” is displayed on performing the “Battery” check in the I/O CHECK menu in the maintenance mode.

- Battery replacing method

Replace the battery by following the procedure given below.

To protect the contents of the memory, the battery must be replaced in less than 5 minutes.

**Caution**

Never short the battery terminals, attempt to charge the battery or take it apart, heat it, or discard it into fire. In the worst case, explosion may occur.

**Operation** 1. Keep the power ON for at least 1 minute and then turn it OFF.

**Note** Unless the power is kept ON for at least 1 minute, the memory contents cannot be retained for more than 5 minutes without a battery.

2. Turn off the power to the NT620S/620C and remove the lid of the CFL case, located at the upper right part of the rear of the NT620S/620C: remove the screw with a Philips head screwdriver, then open the CFL case lid.

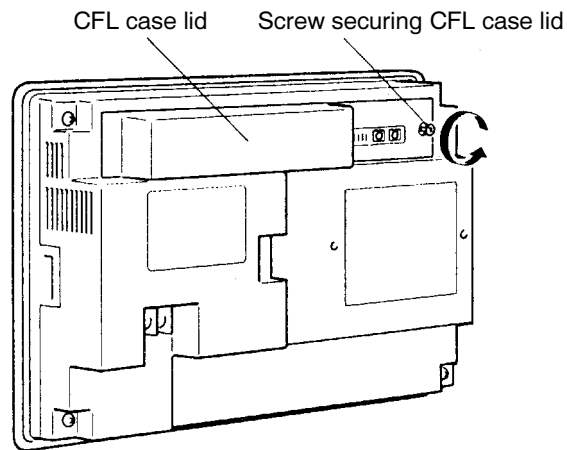

3. Pull out the battery together with the connector.

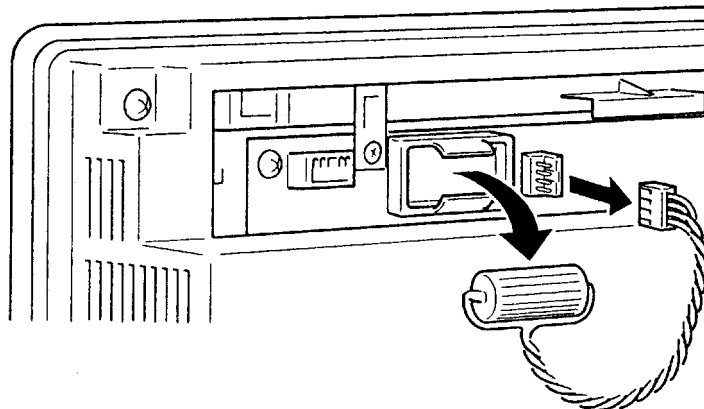

4. Install a new battery.  
Insert the battery connector, keeping it straight.

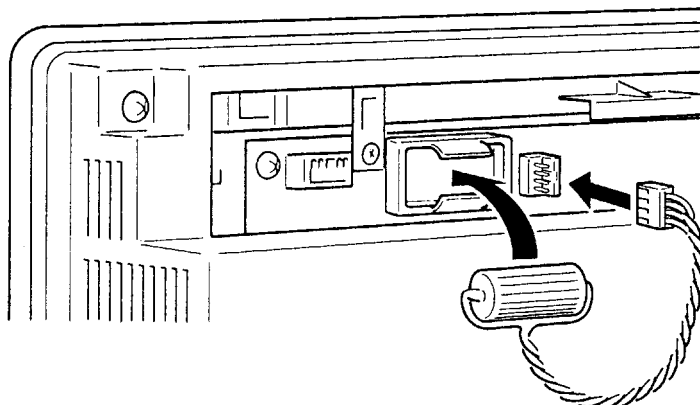

5. Close the CFL case lid and secure it with the screw.

The battery may be replaced while the power is ON. In this case, there are no restrictions on battery replacement time.

 **Caution**

Never short the “+” and “-” terminals of the battery. Do not recharge, take apart, or heat the battery, or discard it into open flame. Attempting any of these will lead to hazards such as fire, leakage of electrolyte, rupture, etc.

When replacing a battery, ensure that the battery terminal does not touch the board in the NT620S/620C.

## 7-4 Inspection and Cleaning

Clean and inspect the NT620S/620C regularly to ensure that it is always used in its optimum condition.

### Cleaning Method

If the display is dirty the screen is difficult to see. Clean the screen from time to time as follows.

- In daily cleaning, wipe the display with a soft dry cloth.
- If the soiling cannot be removed with a dry cloth, wet the cloth with diluted neutral detergent (2%), wring it out well and wipe the display with it.
- If rubber or vinyl products, tape, etc. are left stuck to the display for long periods they will cause staining. If such items are stuck to the display, remove them during cleaning.

### Note

Never use volatile solvents such as benzene or thinners, or chemical dusters. These could cause degeneration of the coatings of the NT620S/620C display and body.

### Inspection Method

In normal environments, inspect the NT620S/620C at intervals of between 6 months and a year. In environments that are extremely hot and humid, or very dusty environments, shorten the inspection interval.

- Items required for the inspection

Prepare the following items before starting the inspection.

- The tools supplied with the NT620S/620C
- Screwdrivers (Philips, flat-head)
- Tester (or digital voltmeter)
- Industrial alcohol
- 100% cotton cloth
- Hygrometer (required in some cases)
- Thermometer (required in some cases)
- Synchroscope (required in some cases)
- Pen-writing oscilloscope (required in some cases)

- Points inspected

Inspect the following points to determine if there is any divergence from the stated criteria. If there is, either improve the surrounding environment so that the values fall within the stated range, or adjust the NT620S/620C.

Point Inspected	Inspection Details	Criterion	Inspection Instrument
Power supply voltage	Fluctuation in power supply terminal voltage	Permissible voltage fluctuation range (24 VDC -15% +10%)	Tester
Ambient environmental conditions	Ambient temperature (temperature in the operation panel)	0 to 45°C (NT620S) 0 to 40°C (NT620C)	Thermometer
	Ambient humidity (humidity in the operation panel)	35% to 85%RH	Hygrometer
	Presence/absence of dust	Dust must not be settled	Visual inspection
Mounting conditions	Looseness of mounting brackets etc.	To be no looseness	Accessory tools
	Connector connections of connecting cable	To be fully inserted and locked, with no looseness	
	Looseness of screws in external wiring	To be no looseness	Philips screwdriver
	Conditions of external connecting cables	Faults such as incipient disconnections.	Visual inspection
Components with limited lives	Brightness of the backlight (NT620C)	Must be sufficiently bright. Backlight life: Brightness is halved after about 10,000 hours in use.	Visual inspection
	Brightness of EL display unit (NT620S)	Must be sufficiently bright. EL display unit life: Brightness is reduced by 30% after about 30,000 hours in use.	Visual inspection



**Caution**

- Be sure to switch the power OFF before replacement.
- Do not disassemble for repairs or modification. Otherwise, the product may malfunction.
- The disposal of the NT620S/NT620C (and used backlights) may be regulated by national and local authorities. Dispose of them in accordance with the laws and regulations of the relevant country and local authority.

**Reference**

Cautions on replacing the NT620S/620C

When replacing the NT620S/620C after discovering a fault during inspections, note the following points:

- After replacement, check that the new NT620S/620C is not subject to the same error.
  
  - If a faulty unit is returned for repairs, write as detailed a description of the fault as possible and send this description together with the unit to the OMRON address indicated on the back cover of this book.
-

## APPENDIX A

### Specifications

#### General Specifications

Item	Specification
Power supply voltage	24 VDC
Allowable power supply voltage range	20.4 VDC to 26.4 VDC (24 VDC -15% +10%)
Power consumption	25 W or less (NT620S) 20 W or less (NT620C)
Ambient operating temperature	0 to +45°C (NT620S) 0 to +40°C (NT620C)
Storage temperature	-20 to +70°C (NT620S) -20 to +60°C (NT620C)
Ambient operating humidity	35 to 85% RH (with no condensation)
Operating environment	No corrosive gases.
Resistance to electrostatic discharge	Level 3 (IEC801-2) In air ±8kV, contact ±6kV, indirect ±7kV
Electromagnetic field strength	10V/m (IEC801-3)
Fast transient/burst noise	Power supply line: 2kV (IEC801-4) I/O line: 0.25kV
Damped oscillatory wave	Power supply line: 1kV (IEC255-4)
Vibration resistance	10 to 22 Hz with 1.5 mm double amplitude for a total of 30 min. in X, Y, and Z directions. 22 to 500 Hz with 1.5 G {14.7 m/s <sup>2</sup> } acceleration in X, Y, and Z directions.
Shock resistance	Durability: 30 G, 3 times each in X, Y, and Z directions. Malfunction: 20 G, 3 times each in X, Y, and Z directions.
Dimensions (mm)	275 (W) x 192 (H) x 71 (D) mm (NT620S) 281 (W) x 198 (H) x 74.4 (D) mm (NT620C)
Weight	2.0 kg max.
Enclosure ratings	Front panel: Equivalent to IP65 and NEMA4 (front face waterproof construction). Rear case: IP20 Terminals: IP00
Applicable standards	EN61131-2 (1994) EN50081-2 (1992)

## Performance Specifications

### Display Specifications (NT620S)

Item	Specification	
EL display (9-inch or equivalent)	Number of dots	400 dots (vertically) x 640 dots (horizontally) (dot size: 0.30 mm)
	Effective display area	120 mm (vertically) x 192 mm (horizontally)
	Life expectancy (When the brightness is reduced to 30%)	Approximately 30,000 hours
	Display color	Yellow orange
	Screen saver	10 minutes/1 hour/None
Indicators	POWER (Green)	Lit while the power is being supplied.
	RUN	Lit during operation. If the battery voltage becomes low, lit in orange during operation and in red when stopped.

### Display Specifications (NT620C)

Item	Specification	
Dot matrix of color STN liquid crystal display panel	Number of dots (resolution)	480 dots (vertically) x 640 dots (horizontally)
	Effective display area	144 mm (vertically) x 192 mm (horizontally)
	View angle	Left/right direction: $\pm 30^\circ$
	Life expectancy	50,000 hours minimum
	Display color	8 colors (black, blue, red, magenta, green, cyan, yellow, white)
Backlight (white cold cathode tube)	Life expectancy	10,000 hours minimum (Average: 20,000 hours)*
	Screen saver	10 minutes/1 hour/None
Indicators	POWER indicator (Green LED)	Lit while power is being supplied.
	RUN indicator	Lit during operation. If the battery voltage becomes low, lit in orange during operation and in red when stopped.



\* It is the time taken for the brightness to decline to half its original value at normal temperature and humidity.

### Panel Specifications

Item	Specification
Touch panel	Number of switches: 512 for NT620S (32 horizontally x 16 vertically) 768 for NT620C (32 horizontally x 24 vertically)
	Maximum number registrable per screen: 256
	Input: Pressure-sensitive type
	Operating force: 100 gf min.
	Life expectancy: 1 million operations minimum



## Display Capacity

Item		Specification
Display elements (*1)	Character display	Fixed character data (character-strings registered for each screen)
	Character-string displays	50 positions per screen (40 bytes per string)
	Numeral displays	50 positions per screen, 8-digit display
	Bar graph displays	50 positions per screen, % display, capable of displaying signs
	Trend graph	One frame per screen, 50 pcs. per frame
	Broken line graph	One frame per screen, 256 pcs. per frame, 512 points per pc., 512 points per screen
	Graphic displays	Can be displayed wherever required.
	Lamps	Max. 1024 lamps per file, 256 positions per screen
	Touch switches	Max. 1024 lamps per file, 256 positions per screen
	Numeral settings	Display of setting numeral values (ten-key type, thumb wheel type), 50 per screen
	Character-string settings	Display of setting character-strings, 50 per screen
	Alarm list	4 groups per screen (The alarm history is displayed in the order of occurrence and frequency, group by group.)
	Alarm history	
	Clock display	Time display of built-in clock by numeral display function
Screen types	Normal screen	Displays screens registered as normal
	Overlapping screen	A maximum of 8 registered screens can be displayed overlapped with each other.
	Continuous screen	A maximum of 8 registered screens can be displayed sequentially by scrolling. (The screen can be scrolled by   keys)
	Window screen	For input setting numeric keys/character keys (maximum of 50 settings). Window screens use screen numbers 1900 to 1979.
	Display history screen	Order of occurrence (max. 1023 screens), order of frequency (max. 255 times)
Screen attribute		Buzzer, display history, numeral setting display Background colors (NT620C only)
Number of screens	Max. number of registered screens	2000 screens
	Screen number	0: No display 1 to 2000: User registered screens (However, 1997 screen is a display history occurrence order screen, 1998 screen is a display history frequency order screen, 1999 screen is a host connecting screen)
Screen registration method		By transferring a screen data created using the support tool to the NT620S/620C.
Screen saving method (screen data memory)		Flash memory (storing format unique to NT620S/620C)

(\*1) The total number of display elements for numeral display, graphs, and numeral settings must be 1024 or less.

## Display Element Specifications

Item	Specifications
Display characters	Half-size characters (8 x 8 dots): Alphanumerics and symbols Normal-size characters (8 x 16 dots): Alphanumerics and symbols Mark (16 x 16 dots): User-defined pictographs (32 x 32 dots) (64 x 64 dots) Image data (NT620S: 8 x 8 to 640 x 400 dots, NT620C: 8 x 8 to 640 x 480 dots): User-defined image character size is set freely in the unit of 8 x 8 dots. Library data (NT620S: 1 x 1 to 640 x 400 dots, NT620C: 1 x 1 to 640 x 480 dots)
Enlargement function	Double width, double height, and magnification of 4x, 9x, 16x, 64x
Smoothing processing	Available for enlarged characters with magnification of 4x or more
Character display attribute	Normal, inverse, flashing, inverse flashing, transparent display
Image data	Variable-size pictograph Size: Min. 8 x 8 dots, max. 640 x 400 dots (NT620S) max. 640 x 480 dots (NT620C) Capable of setting a size in the unit of 8 dots Incapable of setting the enlarged display, smoothing processing, display attributes such as inverse/flashing.
Library data	Combination of any characters and graphics Size: Min. 1 x 1 dot, max. 640 x 400 dots (NT620S) max. 640 x 480 dots (NT620C) Capable of setting any size Enlarged display, smoothing processing, and display attributes such as inverse/flashing are displayed according to the setting registered.
Graphics	Continuous straight line, circle, arc, sector, rectangle, polygon
Line type	4 types only for continuous straight line (solid line, broken line, alternate long and short dash, long and two short dashes)
Painting out	10 types
Graphic display attributes	Normal/inverse flashing, transparent display
Display color (NT620C only)	8 colors (red, green, blue, yellow, magenta, cyan, white, black)
Color specification (NT620C only)	Display color, background color, boundary color (line color)

**Maximum Amount of Various Data**

Item	Specifications
Character-string data	40 characters (normal-size) x 1000; 744 data are only for reading operation
Numeral data	8-digit x 1000
Bit data	One contact x 256
Mark data	224 (in terms of 16 x 16 dots)
Image data	224
Library data	896
Touch switches	Each 1024
Lamps	

## Special Features

Item	Specifications
Buzzer	<p>Three kinds of sound (continuous sound, intermittent short-sound, intermittent long-sound)</p> <p>ON: Reception of a command from the PC, buzzer setting screen display, error screen display such as abnormal reception</p> <p>OFF: Reception of a command from the PC,  key input, screen display without buzzer setting</p> <p>Sound pressure: Min. 80 dB/Average 87 dB (measured at 10 cm in front)</p> <p>Setting: Set the "Buzzer Sound" to "ON" in the "MEMORY SWITCH MENU". "ERR ON" for only when an error occurs.</p>
Maintenance function	<ul style="list-style-type: none"> <li>• Self-test function, such as memory, switch</li> <li>• Setting condition confirmation function, such as communication condition</li> <li>• Communication check function</li> </ul>
Battery retention	<ul style="list-style-type: none"> <li>• Retention of display history data/alarm history data</li> <li>• Retains the numeral/character-string memory table data that existed immediately before operation was terminated (when the resume function is effective).</li> </ul> <p>Battery life: Five years (25°C)</p> <p>When the voltage drops: A message "Battery Lowered" is displayed. The RUN LED is lit in orange or red. Communication flag (BAT LOW) to the PC is ON (1).</p>
Key input sound setting	<p>Touch switch</p> <p>Input sound: Sounds for 0.2 second.</p> <p>Setting: Set the "Key Press Sound" to "ON" in the "MEMORY SWITCH MENU".</p>
Resume function	<p>To retain the contents without initializing the memory table (character-string/numeral value) when turning ON the power, resetting, changing over the operation mode.</p> <p>Setting: Set the "Resume Function" to "ON" in the "MEMORY SWITCH MENU".</p>
Screen print function	<p>To print the screen just displayed by means of printer interface connector.</p> <p>Setting: Set an output specification in the "MEMORY SWITCH MENU".</p> <p>NT620S</p> <p>ESC/P TONE: Conforms to ESC/P 24-J81C</p> <p>PR201H TONE: Conforms to NEC PL-PR201H</p> <p>HP TONE: Conforms to PCL5</p> <p>NT620C</p> <p>ESC/P COLOR: Conforms to ESC/P 24-J83C, color printing</p> <p>ESC/P TONE: Conforms to ESC/P 24-J83C, monochrome 8 grayscale levels</p> <p>PR201H COLOR: Conforms to NEC PL-PR201H</p> <p>HP TONE: Conforms to PCL5</p>

## Communications Specifications

### [For a Host Link]

Item	Specification
Communications standard	EIA RS-232C
Communications settings	Start-stop synchronization Baud rate: 9600, 19,200 bps Data length: 7 bits Stop bit: 2 bits Parity: Even
Connector	9-pin, D-SUB connector (female)
Number of units connected	1 to 1
Transmission distance	Max. 15 m
Communications protocol	C-series SYSWAY (1:N)

### [For an NT Link]

Item	Specification
Communications standard	EIA RS-232C
Connector	9-pin D-SUB connector (female)
Number of units connected	1 to 1
Transmission distance	Max. 15 m*

\* When NT-AL001 used;  
RS-232C cable: Max. 2 m  
RS-422A cable: Total length 500 m

### [For an NT Link (1:N, RS-232C)]

Item	Specification
Communications standard	EIA RS-232C
Connector	9-pin D-SUB connector (female)
Number of units connected	1:1 to 8
Transmission distance	<ul style="list-style-type: none"> <li>• RS-232C cable : Max. 2 m*</li> <li>• RS-422A/485 cable : Total length 500 m*</li> </ul>

\* When NT-AL001 used

**[For a Memory Link]**

Item	Specification	
Communications standard	EIA RS-232C	RS-422A*
Communication settings	Start-stop synchronization Baud rate : 2400, 4800, 9600, 19200 bps Data length : 7, 8 bits Stop bit : 1, 2 bits Parity : None, even, odd Flow control : None, RS/CS, XON/XOFF (RS-CS can only be selected with RS-232C.)	
Connector	9-pin D-SUB connector (female)	9-pin D-SUB connector (female) (NT620S/NT620C)
Number of units connected	1:1	
Transmission distance	Max. 15 m	RS-232C cable: Max. 15 m RS-422A cable: Total length 500 m

\* An RS232C/RS422 converter unit is required.

# APPENDIX B

## Dimensions

### Body (NT620S-ST211(B))

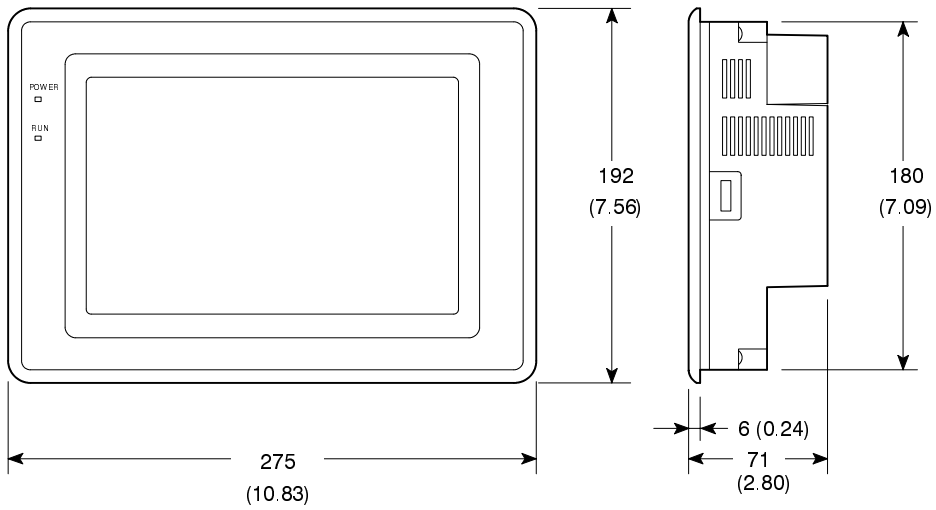
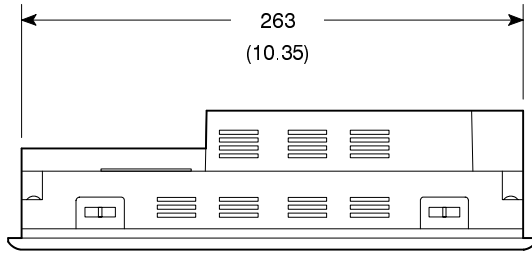

Unit : mm (inch)

Body (NT620C-ST141(B))

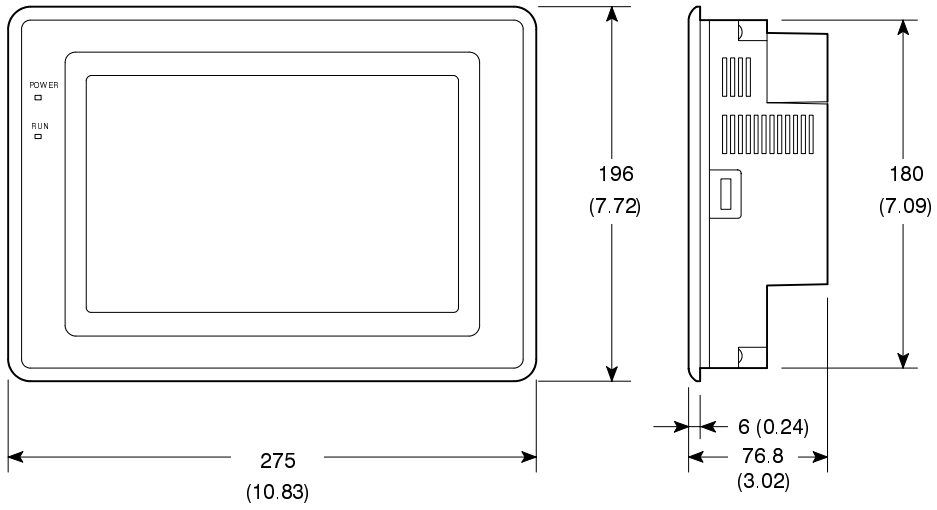
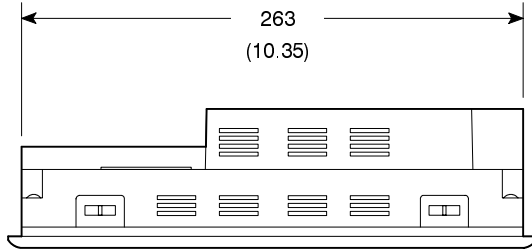

Unit : mm (inch)



- Cable connection dimensions (common to NT620S and NT620C)

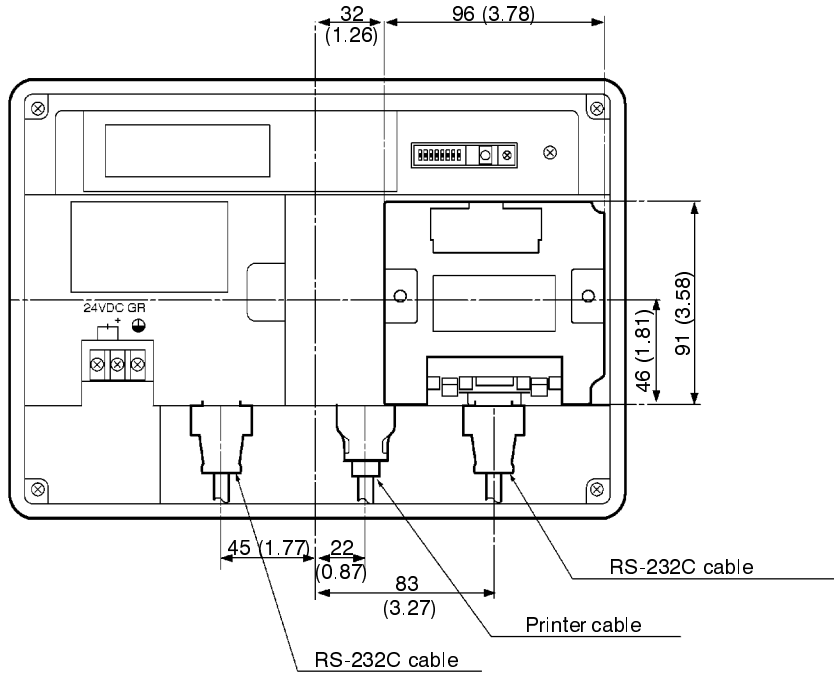

Unit : mm (inch)

- Dimensions for Installation

[NT620S/NT620C]

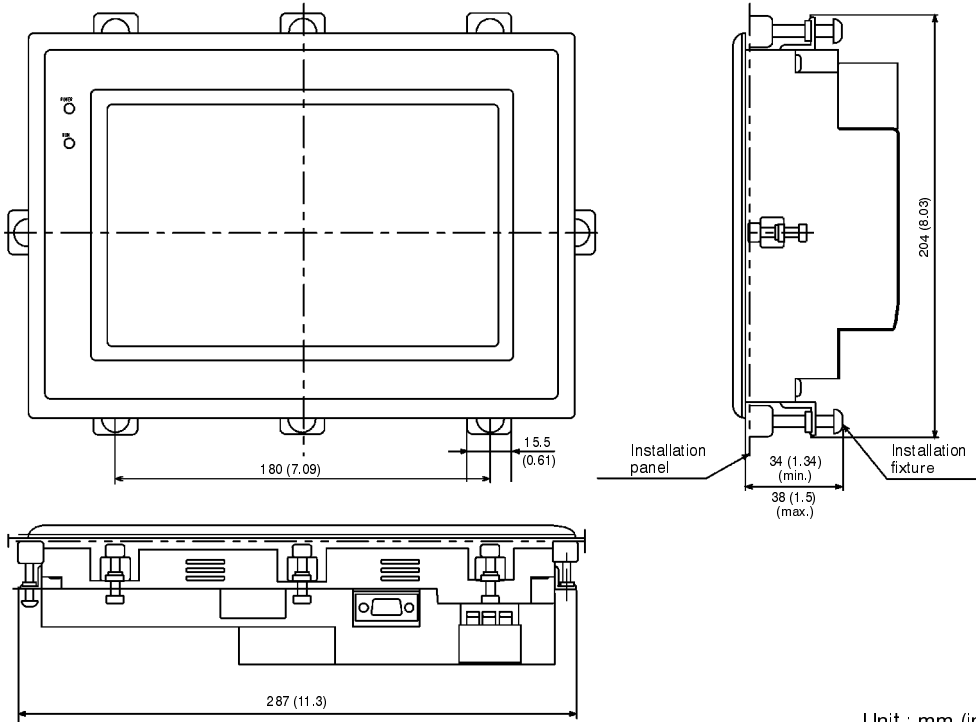

Unit : mm (inch)

## APPENDIX C

### Handling the RS-232C/RS-422 Converter Unit

This section shows the dimensions of the RS-232C/RS-422 converter unit (NT-AL001), and describes the methods for installing and removing it. Refer to this information when designing the control panel.

#### Dimensions

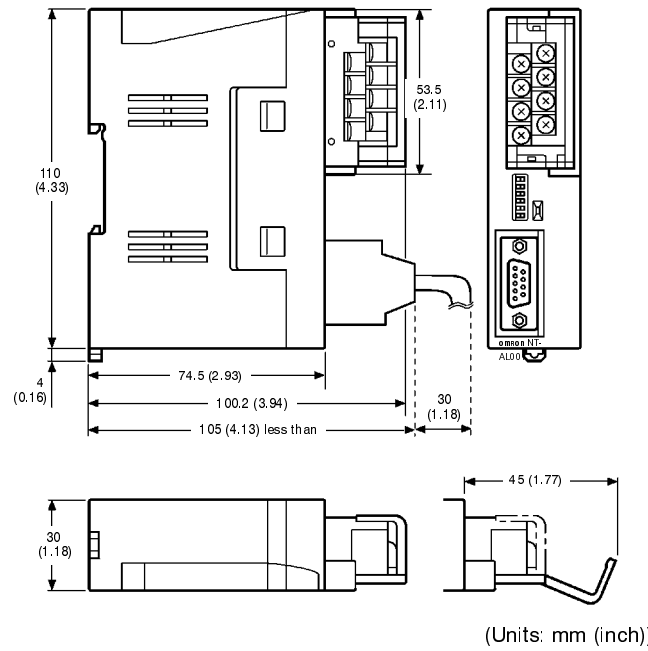

With RS-422A terminal block cover closed: 30 (W) × 114 (H) × 100.2 (D) mm

With RS-422A terminal block cover open: 30 (W) × 114 (H) × 119.5 (D) mm

## Installation and Removal

The RS-232C/RS-422 converter unit (NT-AL001) is installed on a DIN rail or in an operation panel.  
The RS-422 terminal block of the converter unit can easily be removed.

### Installation on a DIN Rail

Hook the top part of the rear of the converter unit ((a) in the figure) onto the top edge of the DIN rail, and push the unit in direction (b).

Then fit end plates on the right and left sides of the converter unit so that the unit cannot shift sideways.

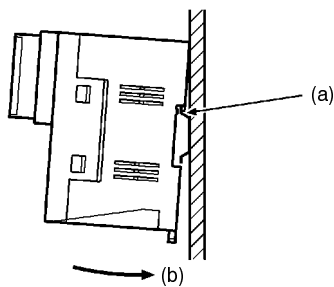

### Removal from the DIN Rail

Remove the end plates at right and left, then insert a flat-tipped screwdriver into the rail stopper on the bottom of the unit and pry the unit away.

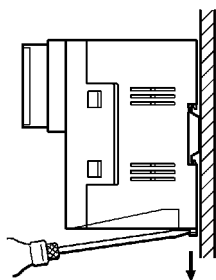

### Installation in an Operation Panel

Make two screw holes in an operation panel wall at least 2 mm thick and secure the converter to the wall with screws.

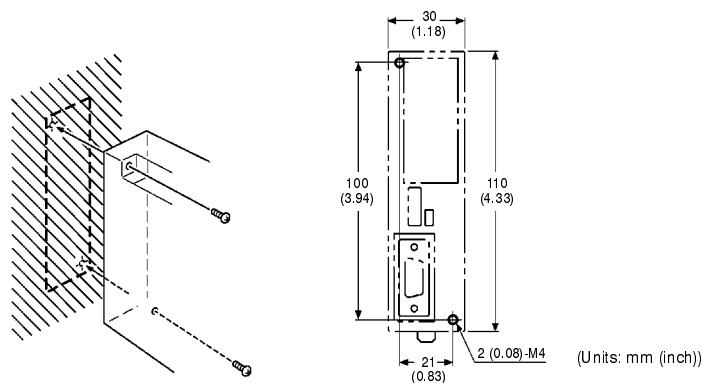

**Note**

In order to ensure a strong installation, the wall of the operation panel must be at least 2 mm thick.

## **APPENDIX D**

### **NT620S/620C Installation Environment**

 **Caution**

When installing the PT in the operation panel, observe the following points.

- Do not install the unit in locations directly exposed to chemicals or steam, or locations where there is excessive dust.
- Do not install the unit at locations where the ambient temperature goes outside the range 0 to 45°C in the case of the NT620S and 0 to 40°C in the case of the NT620C, or where the relative humidity goes outside the range 35 to 85% RH.  
If the ambient temperature exceeds the range indicated above, install a fan or an air conditioner.
- Do not install the unit directly above equipment that generates a lot of heat (heaters, transformers, large capacity resistors, etc.)

**⚠ Caution**

- Take the following points into account in order to prevent noise.
  - (1) Avoid installing the unit in panels in which high-voltage equipment is also installed.
  - (2) Install the unit at a distance of at least 200 mm from power lines.
  - (3) If the unit is installed next to equipment that generates a strong electric or magnetic field (solenoids, etc.), provide a gap of at least 40 mm.
- Provide sufficient space for ventilation
- Do not install the unit in locations where it will be subject to strong vibration or severe shock.
- To ensure that the unit can be operated and maintained without difficulty, install it at a distance from high-voltage equipment and power equipment.

---

**Note**

- The view angle of the LCD of NT620C screen is 30° to the left and 30° to the right. Install it at a position and height where operators will be able to see it well.
  - Install the unit as far as possible from personal computers, amateur radio equipment, radios, etc. The radio waves generated by the unit may cause interference that will affect these types of equipment.
-

## **APPENDIX E**

### **Transporting and Storing the NT620S/NT620C**

Pack the NT620S/NT620C in the packaging intended for it before transporting it.

Store the NT620S/NT620C in a location that meets the following conditions.

Ambient temperature : -20 to 70°C (NT620S)  
-20 to 60°C (NT620C)

Ambient humidity : 35 to 85% RH

## APPENDIX F

### NT620S/620C Internal Processing

The following processing is executed inside the NT620S/620C. Processing is divided into two types: periodic processing and incidental processing.

#### Periodic Processing

The following processing is executed inside the NT620S/620C to enable high-speed control from the PC.

Usually, the only data read from the PC are the elements used for the currently displayed screen. Even if the contents of the PC words allocated to memory tables are changed, these contents are not updated at the PT unless the memory table is used for the displayed screen. However, the bit memory tables that can be used with Ver.3 and later versions of the direct connection function can be set to be read continually.

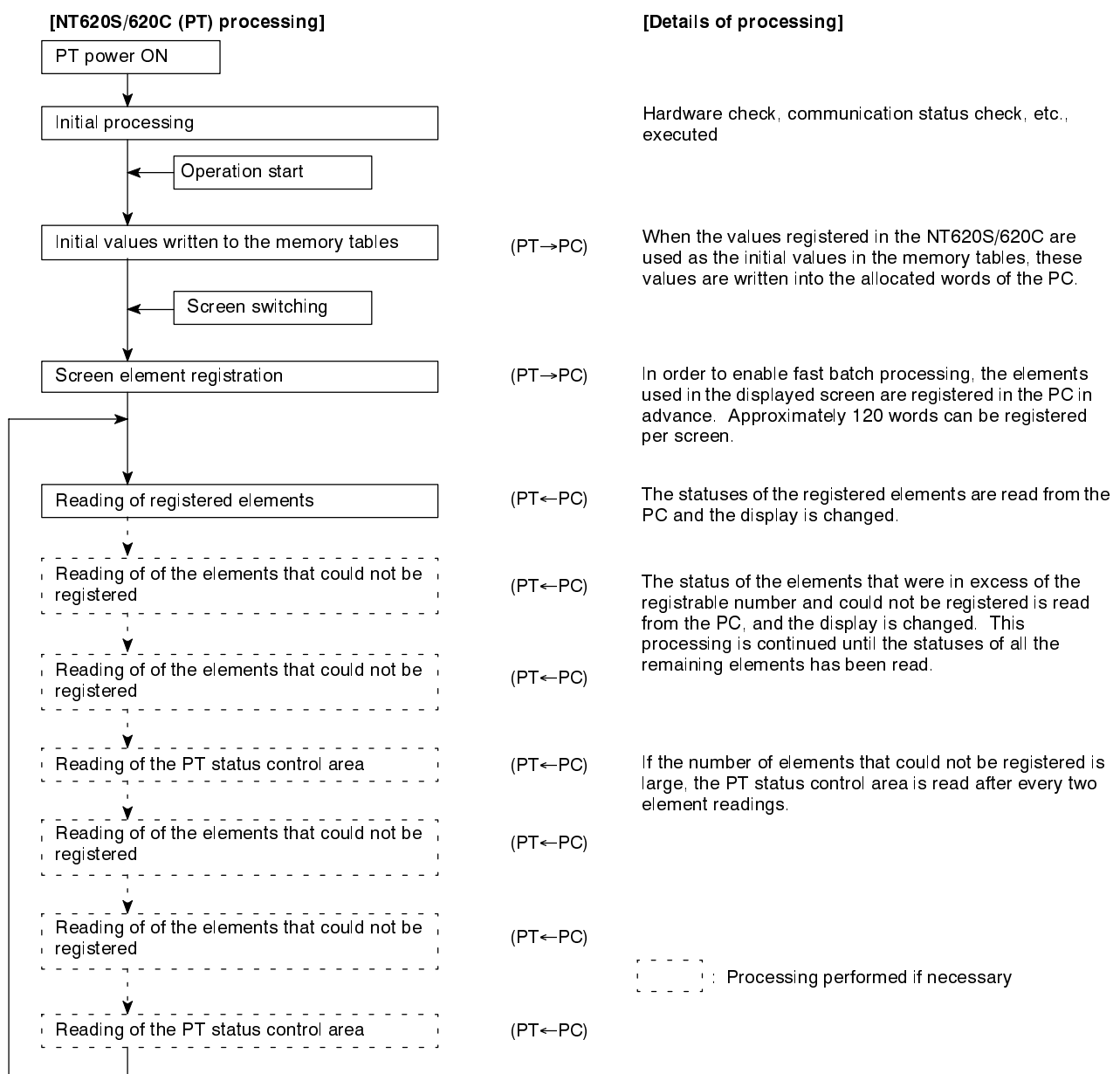

- Number of words for screen element registration

The number of words used for screen element registration is as follows.

Allocated words:    Number of words

Allocated bits:     Number of words calculated by summing the number of bits in each area and taking 1 word to be 16 bits.

Example:

Character string memory tables:	3 of 12 allocated words each
Numeral memory tables:	4 of 2 allocated words each
Allocated bits for control:	19 I/O relays, 7 link relays (contiguous bits)

The number of words assigned to character string memory tables and numeral memory tables is as follows:

$$12 \text{ words} \times 3 + 2 \text{ words} \times 4 = 44 \text{ words}$$

The assignment for bits is as follows:

$$19 \text{ I/O relays}/16 = 1 \text{ word with a remainder of } 3 \text{ bits} \rightarrow 2 \text{ words}$$

$$7 \text{ link relays}/16 = 0 \text{ words with a remainder of } 7 \text{ bits} \rightarrow 1 \text{ word}$$

The total is therefore 44 words + 2 words + 1 word = 47 words

Elements occupying up to approximately 120 words, calculated in this way, can be registered. If the number of elements is larger than this, internal processing is increased in proportion to the excess number and this generates a delay in processing.

If the point where the registrable quantity is exceeded is in the middle of an element that spans several words (for example a character string memory table), registration is quit without registering that element.

If there are bit memory tables that have been set to be read continuously, the requirement for this processing is also registered. If the number of such bit memory tables is large, processing will be delayed.

- Order of priority for registration

Elements are registered in the following order of priority according to their type.

- (1) Allocated words of the PT status control area
- (2) Allocated bits for control (lamps, lamp bits of touch switches, bit memory tables)
- (3) Allocated words of numeral memory tables
- (4) Allocated words of character string memory tables

If there is more than one element for each of (2) through (4), the elements are registered in accordance with the following priority of word and bit areas:

- (1) Data memory (DM)
- (2) I/O relays (CH)
- (3) Timers (TIM)
- (4) Counters (CNT)
- (5) Holding relays (HR)
- (6) Auxiliary relays (AR)

Within each area, words and bits are allocated from the smallest number up.



## Incidental Processing

When the status of the NT620S/620C changes during operation (ex. touch switch is pressed), the processing for writing the changed data to the relevant area of the PC memory is executed.

This kind of processing is only executed when statuses change. When changes occur simultaneously, the processes are executed in accordance with the order of priority.

[NT620S/620C processing]		[Details of processing]	
Order of priority ↑ High ↓ Low	Writing to the PT status notify area	(PT→PC)	Writing to the PT status notify area in order to inform the PC of changes in the PT operating status.
	Bit writing	(PT→PC)	Writing to bits in order to inform the PC that a touch switch has been pressed.
	Writing to numeral memory tables	(PT→PC)	Changing the contents of words allocated to the PC when the value in a numeral memory table has changed.
	Writing to character string memory tables	(PT→PC)	Changing the contents of words allocated to the PC when the value in a numeral memory table has changed.

Data is only written to PC bits and numeral/character string memory tables for elements in screens currently being displayed. If the contents of numeral/character string memory tables that are not being displayed change, the changed contents are not written to the PC.

## APPENDIX G

### Method for Making the Cable for Connection to the PC

Explained below is the method for making the cable that connects the NT620S/620C and the PC.

Connect the wires to the connectors in accordance with the connector specification for each unit.

#### Parts Required

Two connectors, two connector covers and one cable are required to make up a connecting cable. One connector and one connector cover is supplied with most PCs.

Name	Model	Delivered with	Remarks
Connector	XM2A-0901	C series CQM1 CVM1/CV series CPU unit CV500-LK201	9-pin, manufactured by OMRON
	XM2A-2501	C500-LK203 C500-LK201 C200H-LK201	25-pin, manufactured by OMRON
	DB-25P	C500-LK201-V1 C120-LK201-V1	25-pin, manufactured by JAE
Connector Cover	XM2S-0911	C series CQM1, C200HS, C200HX/HG/HE CVM1/CV series CPU unit CV500-LK201	9-pin, manufactured by OMRON
	XM2S-2511	C500-LK203 C500-LK201 C200H-LK201(-V1)	25-pin, manufactured by OMRON
	DB-C2-J9	C500-LK201-V1 C120-LK201-V1	25-pin, manufactured by JAE

When connecting the NT620S/620C to an OMRON PLC C□□H, the connector and the connector must be prepared separately since they are not supplied with the C□□H.

The connector provided in the CPU unit of the C□□H is a 9-pin connector. For the connection, the following connector and connector cover should be prepared.

- Connector: XM2A-0901 (9-pin type, OMRON)
- Connector cover: XM2S-0911 (9-pin type, OMRON)

Prepare the cable recommended by OMRON.

The recommended cables are indicated in the following table.

Name	Type	Remark
Cable	AWG28X5P IFVV-SB	Multiconductor shielded cable (FUJIKURA, Ltd.)
	CO-MA-VV-SB 5PX28AWG	Multiconductor shielded cable (HITACHI Cable, Ltd.)

## Connector Specifications and Wiring for OMRON Units

The combination of pin numbers to which the connecting wires are connected differs according to the connector specifications for each unit. Check the connector specifications of the unit to be connected and make the wiring connections for the items in the connection combination indicated below which are applicable.

### [NT620S/620C Connector Specifications (9-pin)]

- Electrical characteristics: Complies with EIA RS-232C
- Signal direction: Signal input and output is relative to NT620S/620C.

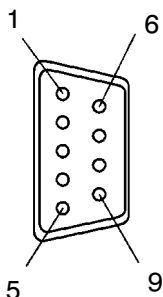

Connector Pin No.	Signal Name	Abbreviation	Signal Direction	
			Input	Output
2	Send data	SD (TXD)		○
3	Receive data	RD (RXD)	○	
4	Request to send	RS (RTS)		○
5	Clear to send	CS (CTS)	○	
6	+5V (150 mA max.)	+5V	-	-
9	Signal ground	SG	-	-

- ⚠ Caution** Check that the current capacity of the equipment to be supplied is within 150 mA before using the +5 V output of pin No.6. The +5 V output of NT620S/NT620C delivers +5 V ± 5% and 150 mA maximum.  
Do not use the +5 V output of the RS-232C interface unit.

### Connecting an NT620S/620C to a C-Series Host Link

- C-Series host link unit 25-pin connector specifications

Applicable host link unit:  
 C200H-LK201(-V1)  
 C500-LK201-V1  
 C500-LK203  
 C120-LK201-V1

- Electrical characteristics: Complies with EIA RS-232C
- Signal direction: Signal input and output is relative to the PC.

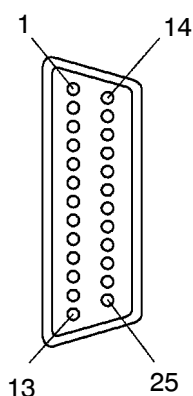

Connector Pin No.	Signal Name	Abbreviation	Signal Direction	
			Input	Output
1	Frame ground	FG	-	-
2	Send data	SD (TXD)		○
3	Receive data	RD (RXD)	○	
4	Request to send	RS (RTS)		○
5	Clear to send	CS (CTS)	○	
7	Signal ground	SG (GND)	-	-
14	Optical connector +5V (see note 2)	+5V	-	-
15	Send signal element timing 2 (see note 1)	ST2	○	
17	Receive signal element timing (see note 1)	RT	○	
20	Data terminal ready	ER (DTR)		○
24	Data signal element timing (see note 1)	ST1		○

- Note 1. No element timing signals on C200H-LK201(-V1)  
 2. C500-LK201 and C200H-LK201(-V1) only

• Wiring connections

The NT620S/620C does not use pin 4 (RS) or pin 5 (CS). Either short the RS and CS pins of the PC connector together or set the CTS setting selector switch at the rear face of the host link unit to "0V" (see \* in the figure).

Connect the cable shielding wire to the connector cover and pin 1 at the host link unit end of the cable only.

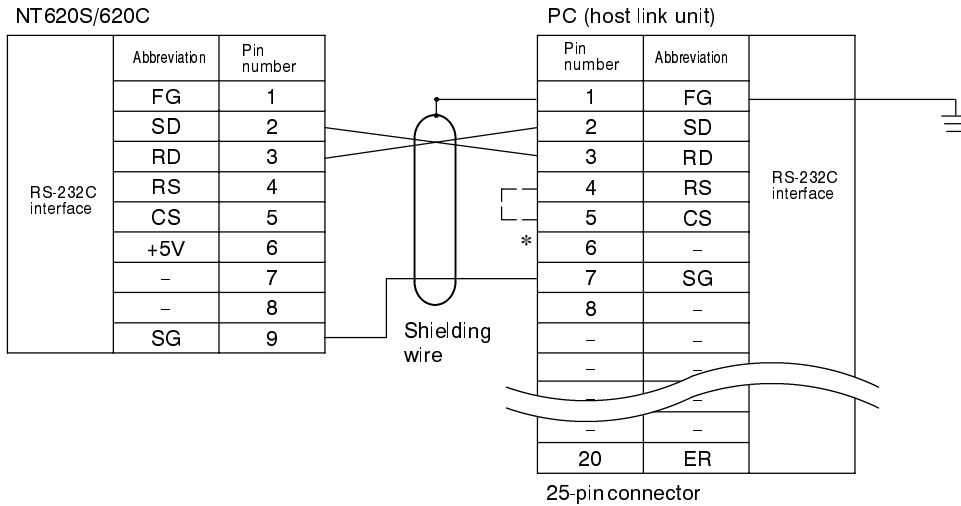

**Connecting an NT620S/620C to a C-Series CPU (C□□H)**

• C-series CPU unit (C□□H) 9-pin connector specifications

- Applicable CPU: C20H/C28H/C40H/C60H
- Electrical characteristics: Complies with EIA RS-232C
- Signal direction: Signal input and output is relative to the PC.

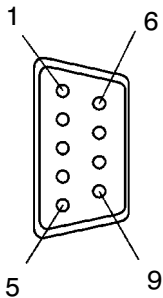

Connector Pin No.	Signal Name	Abbreviation	Signal Direction	
			Input	Output
1	Frame ground	FG	-	-
2	Send data	SD (TXD)		○
3	Receive data	RD (RXD)	○	
4	Request to send	RS (RTS)		○
5	Clear to send	CS (CTS)	○	
7	Signal ground	SG (GND)	-	-

• Wiring connections

The NT620S/620C does not use pin 4 (RS) or pin 5 (CS). Short the RS and CS pins of the PC connector together (see \* in the figure).

Connect the cable shielding wire to the connector cover and pin 1 at both the NT620S/620C and CPU ends of the cable.

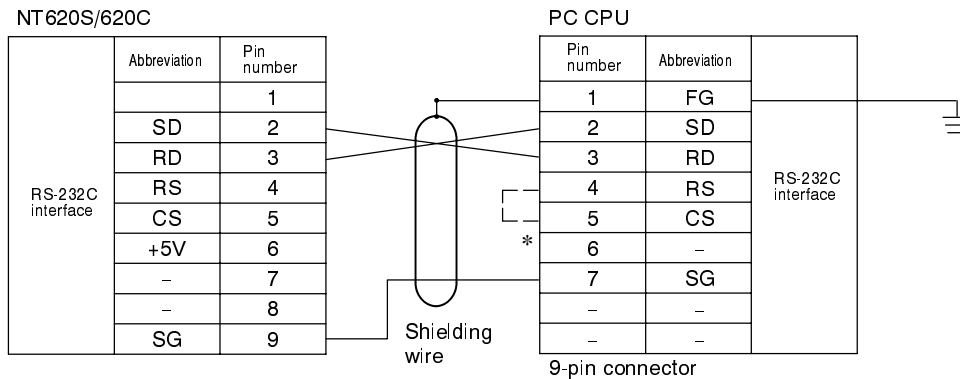

**Connecting an NT620S/620C to a CVM1/CV-Series Host Link Unit**

• CVM1/CV-series host link unit connector specifications

- Applicable host link unit: CV500-LK201
- Electrical characteristics: Complies with EIA RS-232C
- Signal direction: Signal input and output is relative to the PC.

**Communication port 1 (25-pin Connector)**

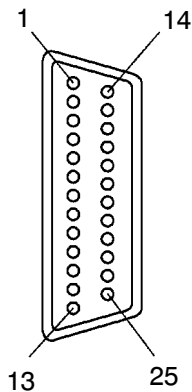

Connector Pin No.	Signal Name	Abbreviation	Signal Direction	
			Input	Output
Connector cover	Frame ground	FG	-	-
1	Frame ground	FG	-	-
2	Send data	SD (TXD)		○
3	Receive data	RD (RXD)	○	
4	Request to send	RS (RTS)		○
5	Clear to send	CS (CTS)	○	
7	Signal ground	SG (GND)	-	-
8	Carrier detected	CD (DCD)	○	
14	Optical connector +5V	+5V		○
20	Data terminal ready	ER (DTR)		○

**Communication port 2 (9-pin Connector)**

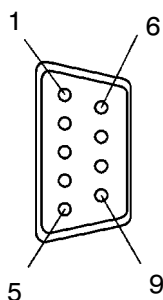

Connector Pin No.	Signal Name	Abbreviation	Signal Direction	
			Input	Output
Connector cover	Frame ground	FG	-	-
2	Send data	SD (TXD)		○
3	Receive data	RD (RXD)	○	
4	Request to send	RS (RTS)		○
5	Clear to send	CS (CTS)	○	
9	Signal ground	SG (GND)	-	-

• Wiring connections

CVM1/CV-series host link units have two types of connector, which must be wired differently.

The NT620S/620C does not use pin 4 (RS) or pin 5 (CS). Either short the RS and CS pins of the PC connector together or set the CTS setting selector switch at the rear face of the host link unit to "0V" (see \* in the figure).

Connect the cable shielding wire to the connector cover and pin 1 at the host link unit end of the cable only.

**Communication port 1 (25-pin Connector)**

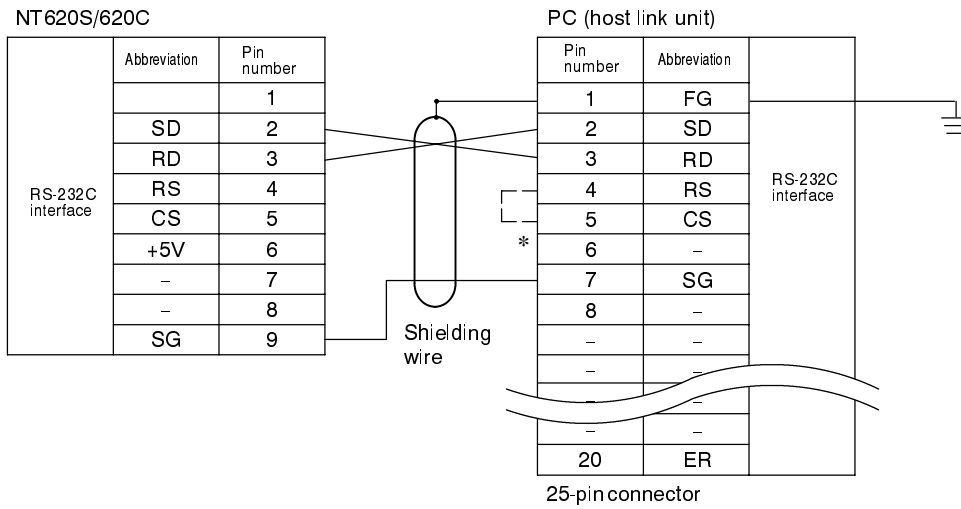

**Communication port 2 (9-pin Connector)**

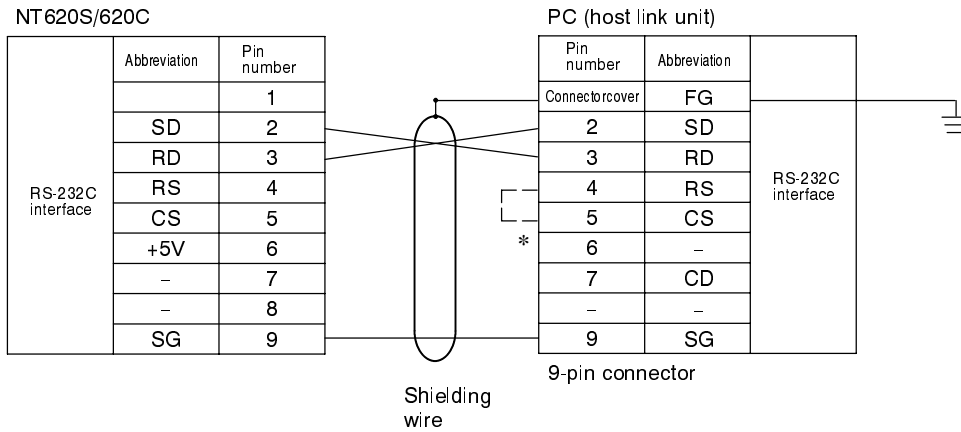

**Connecting an NT620S/NT620C to a C-Series C200HS, C200HX/HG/HE, CPM1, CQM1, or CVM1/CV-Series (-EV□) CPU (Including Communication Board)**

- C-series C200HS, C200HX/HG/HE, CPM1, CQM1, CVM1, CVM1/CV series (-EV□) CPU unit 9-pin connector specifications

Applicable CPU units:

CPM1-10CDR-□	CQM1-CPU21-E	CV500-CPU01-EV1	C200HS-CPU21-E	C200HE-CPU32-E
CPM1-20CDR-□	CQM1-CPU41-E	CV1000-CPU01-EV1	C200HS-CPU23-E	C200HE-CPU42-E
CPM1-30CDR-□	CQM1-CPU42-E	CV2000-CPU01-EV1	C200HS-CPU31-E	
	CQM1-CPU43-E	CVM1-CPU01-EV□	C200HS-CPU33-E	C200HG-CPU33-E
	CQM1-CPU44-E	CVM1-CPU11-EV□		C200HG-CPU43-E
		CVM1-CPU21-EV□		C200HG-CPU53-E
				C200HG-CPU63-E
				C200HX-CPU34-E
				C200HX-CPU44-E
				C200HX-CPU54-E
				C200HX-CPU64-E

**Note** The host link function incorporated in CV/CVM1 CPUs (with the exception of -EV□) cannot be used.

- Electrical characteristics: Complies with EIA RS-232C
- Signal direction: Signal input and output is relative to the PC.

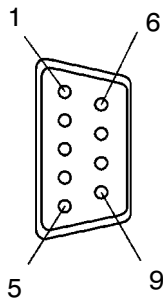

Connector Pin No.	Signal Name	Abbreviation	Signal Direction	
			Input	Output
Connector cover	Frame ground	FG	-	-
2	Send data	SD (TXD)		○
3	Receive data	RD (RXD)	○	
4	Request to send	RS (RTS)		○
5	Clear to send	CS (CTS)	○	
9	Signal ground	SG (GND)	-	-

- Wiring connections

The NT620S/620C does not use pin 4 (RS) or pin 5 (CS). Either short the RS and CS pins of the PC connector together or set the CTS setting selector switch at the rear face of the host link unit to "0V" (see \* in the figure).

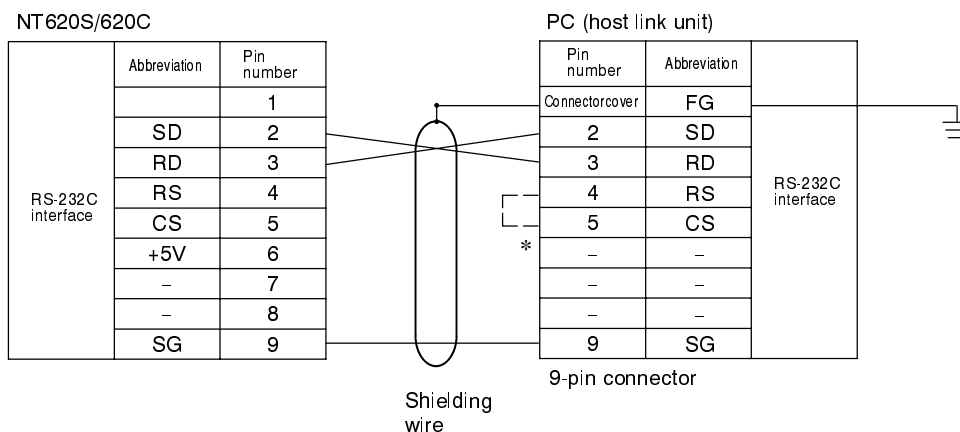

**Connecting an NT620S/NT620C to an RS-232C/RS-422 Converter Unit (NT-AL001)**

Connecting to an RS-232C/RS-422 converter unit allows transmissions over distances greater than 15 m (maximum of 500 m).

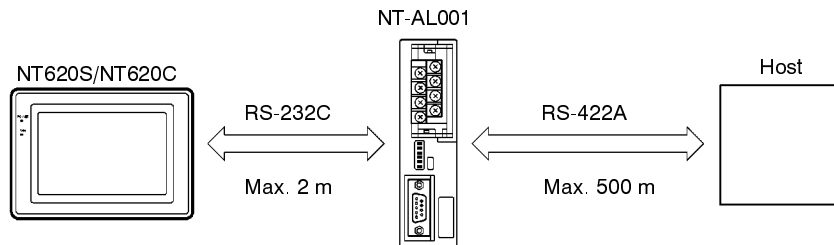

**Reference**

When connecting a C200HX/HG/HE and an RS-232C/RS-422 converter unit, use a converter unit whose lot number is 15Y5 or higher. Converter units of lot numbers previous to 15Y5 cannot be connected.

**NT-AL001 RS-232C Connector Specifications (9-pin Type)**

Electrical characteristics : Conform to EIA RS-232C

Signal direction : Signal input and output is relative to the NT-AL001.

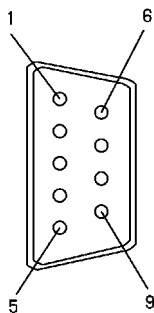

Connector Pin No.	Signal Name	Abbreviation	Signal Direction	
			Input	Output
Connector cover	Grounding or earth for safety purposes	FG	-	-
2	Send data	SD(TXD)		○
3	Receive data	RD(RXD)	○	
4	Request to send	RS(RTS)		○
5	Clear to send	CS(CTS)	○	
6	+5V input	+5V	○	
9	Signal ground	SG(GND)	-	-



**NT-AL001 RS-422A terminal block specifications**

Connected terminal block : RS-422A terminal block (M3 screws)

Electrical characteristics : Conform to EIA RS-422A

Signal direction : Signal input and output is relative to the NT-AL001.

Terminal Block Pin No.	Signal Name	Abbreviation	Signal Direction	
			Input	Output
8	Request to send A	CSA (CS-)		○
7	Request to send B	CSB (CS+)		○
6	Receive data A	RDA (RD-)	○	
5	Receive data B	RDB (RD+)	○	
4	Send data A	SDA (SD-)		○
3	Send data B	SDB (SD+)		○
2	Signal ground	SG	-	-
1	Functional ground	FG	-	-

**Note** The CSB and CSA signals are for special applications.

**Wiring**

[For NT620S/NT620C]

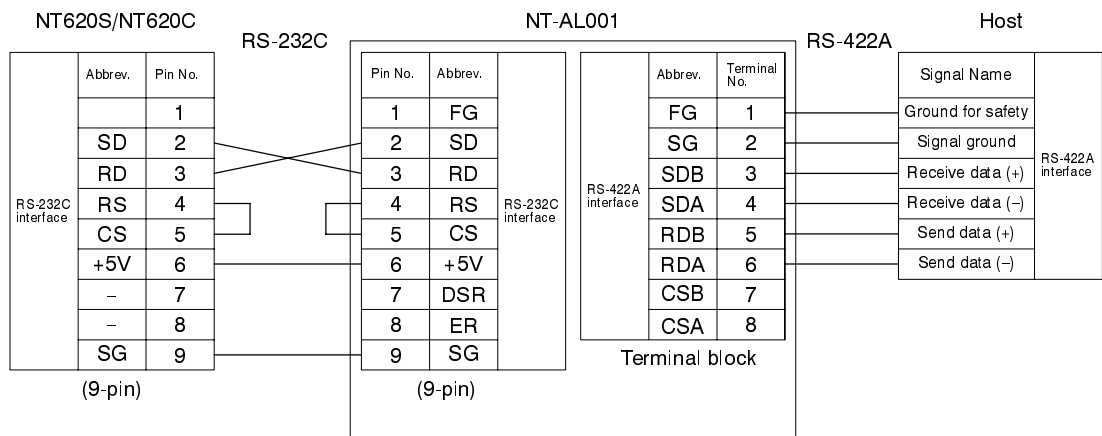

## Making the Cable

The procedure to make up the cable is described below.

### Cable Preparation

The preparation of the cable differs according to whether or not the shielding wire is to be connected to the FG.

- Cable with shielding wire connected to FG

- (1) Cut the cable to the required length.
- (2) Remove the external vinyl insulation from the cable with a razor blade. Take care not to damage the shielding underneath.
- (3) Cut back the shielding wire with scissors.
- (4) Use wire strippers to strip the insulation from each wire.
- (5) Fold back the shielding wire.
- (6) Wrap aluminum foil tape around the folded-back shielding wire.

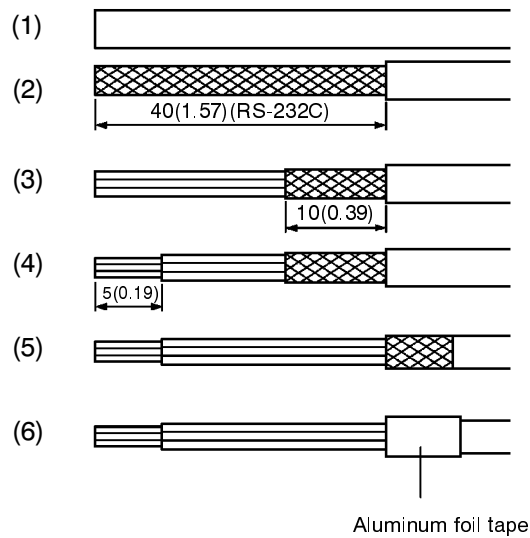

[Units: mm (in.)]

- Cable with shielding wire not connected to FG

- (1) Cut the cable to the required length.
- (2) Remove the external vinyl insulation from the cable with a razor blade. Take care not to damage the shielding underneath.
- (3) Cut back the shielding wire with scissors.
- (4) Use wire strippers to strip the insulation from each wire.
- (5) Wrap vinyl tape over the cut off end of the shielding wire.

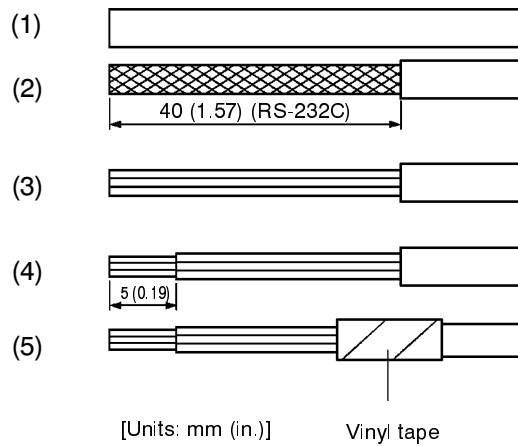

**Soldering**

- (1) Slide heat-shrink tube over each wire.
- (2) Pre-solder each wire and connector cable.
- (3) Solder each wire to the connector terminal.

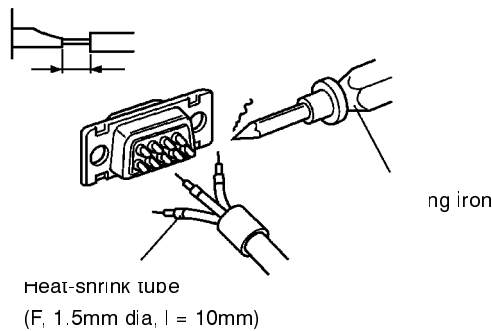

- (4) Push the heat-shrink tube over the soldered joint and heat the tube to shrink it in place.

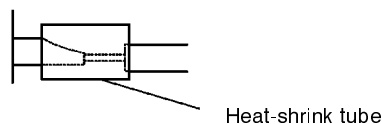

**Connector Cover Assembly**

Assemble the connector covers as shown in the diagram below.

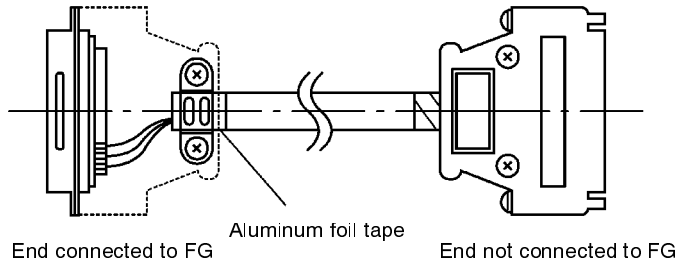

## APPENDIX H

### Making the Cable for Connection to the Support Tool

The wiring to be done depends on the type of RS-232C connector at the personal computer.

- For a 25-pin connector

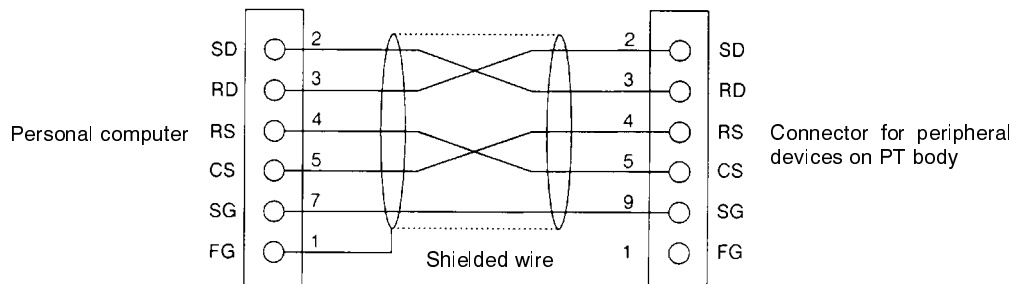

The table below indicates the recommended parts for making the connection cable.

Name	Model	Remarks
Connector	XM2A-2501	25-pin, manufactured by OMRON
	XM2A-0901	9-pin (Plug), manufactured by OMRON
Connector cover	XM2S-2511	25-pin, manufactured by OMRON
	XM2S-0911	9-pin, manufactured by OMRON
Cable	AWG28X5P IFVV-SB	Multicore cable, manufactured by Fujikura, Ltd
	CO-MA-VV-SB 5PX28AWG	Multicore cable, manufactured by Hitachi Cable, Ltd

- For a 9-pin connector

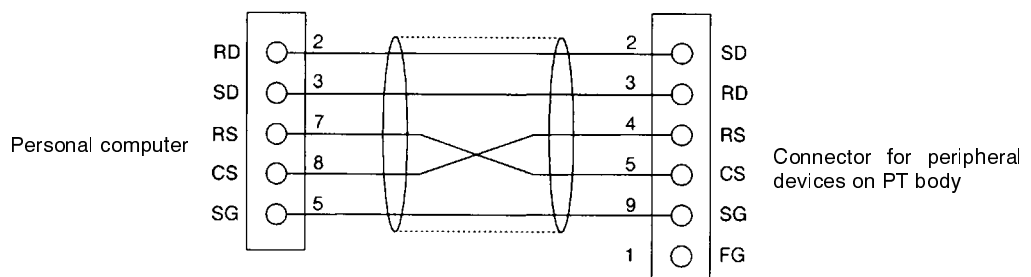

The table below indicates the recommended parts for making the connection cable.

Name	Model	Remarks
Connector	XM2D-0901	9-pin (Socket), manufactured by OMRON
	XM2A-0901	9-pin (Plug), manufactured by OMRON
Connector cover	XM2S-0911	9-pin, manufactured by OMRON
Cable	AWG28X5P IFVV-SB	Multicore cable, manufactured by Fujikura, Ltd
	CO-MA-VV-SB 5PX28AWG	Multicore cable, manufactured by Hitachi Cable, Ltd

## APPENDIX I

### Connecting to an RS-232C/RS-422 Converter Unit

By using an RS-232C/RS-422 converter unit (NT-AL001), RS-232C can be converted to RS-422A, allowing long-distance communication of up to 500 m.

#### Connection Method

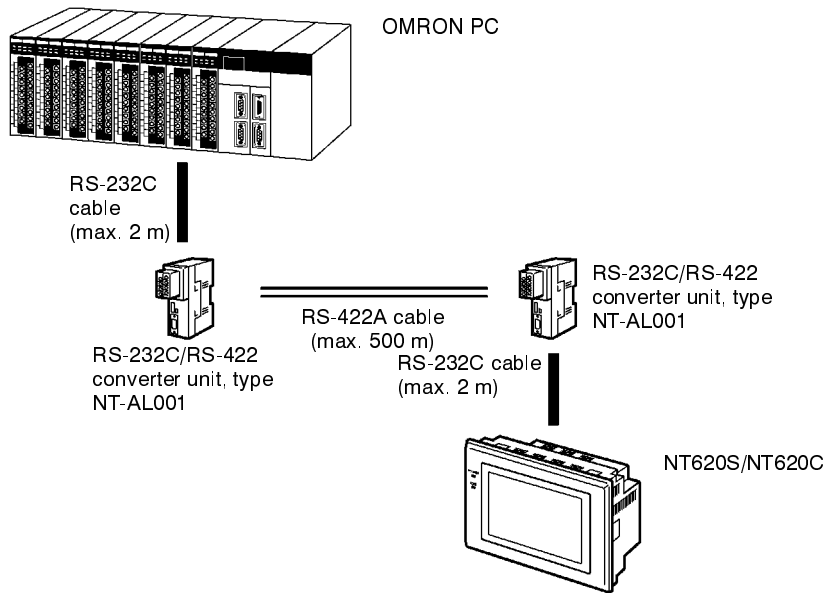

#### Wiring

- Wiring of RS-232C cable

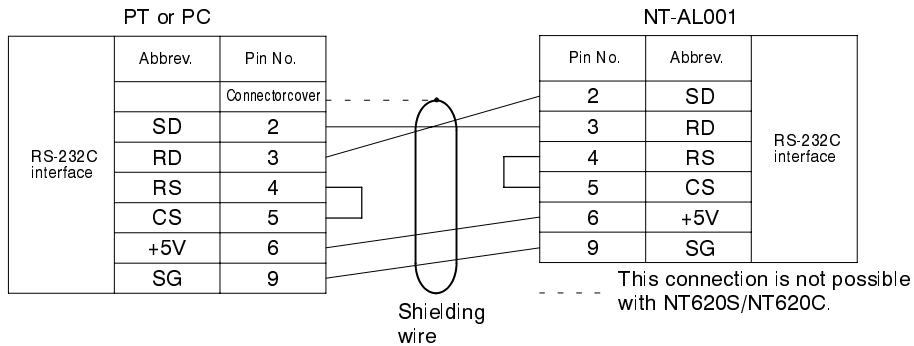

**DIP Switch Settings**

- DIP switch settings at RS-232C/RS-422 converter unit

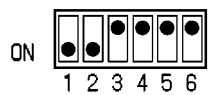

Set the NT620S/NT620C memory switches in accordance with the communication method used.

## APPENDIX J

### Model List

#### PT

Model	Specification
NT620S-ST211-E	NT620S (Beige)
NT620S-ST211B-E	(Black)
NT620C-ST141-E	NT620C (Beige)
NT620C-ST141B-E	(Black)

#### Host Link Unit

Model	Specification	Applicable PC
C120-LK201-V1	CPU-mounted type with RS-232C connector	C-series C120 C200H C500(F) C1000H C2000 (H)
C200H-LK201(-V1)	Rack-mounting Unit with RS-232C connector for C200H	C-series C200H C200HS
C500H-LK201-V1	Features a selectable RS-232C/RS-422 connector	C-series C500(F) C2000(H) C1000H
C500-LK203	Rack-mounting Unit for C500	
CV500-LK201	<ul style="list-style-type: none"> <li>Features an RS-232C connector and a selectable RS-232C/RS-422 connector</li> <li>Rack-mounting Unit for CVM1/CV</li> </ul>	CVM1/CV-series CV500 CV1000 CV2000 CVM1



## CPU's (For Connection Via a Host Link)

Model	Specification	PC Type
C20H/C28H/C40H/C60H	Features a 9-pin connector for RS-232C connections	C-series C20H C28H C40H C60H
CPM1-10CDR-□ CPM1-20CDR-□ CPM1-30CDR-□	RS-232C adapter, RS-422A adapter connected to the peripheral port	C-series CQM1
CQM1-CPU21-E CQM1-CPU41-E CQM1-CPU42-E CQM1-CPU43-E CQM1-CPU44-E	Features a 9-pin connector for RS-232C connections	C-series CQM1
C200HS-CPU21-E C200HS-CPU23-E C200HS-CPU31-E C200HS-CPU33-E	Features a connector for RS-232C connections (selectable/9-pin)	C200HS
C200HE-CPU32-E(*) C200HE-CPU42-E	Features a connector for RS-232C connections (selectable/9-pin)	C-series C200HE
C200HG-CPU33-E(*) C200HG-CPU43-E C200HG-CPU53-E(*) C200HG-CPU63-E	Features a connector for RS-232C connections (selectable/9-pin)	C-series C200HG
C200HX-CPU34-E(*) C200HX-CPU44-E C200HX-CPU54-E(*) C200HX-CPU64-E	Features a connector for RS-232C connections (selectable/9-pin type)	C-series C200HX
CV500-CPU01-EV1 CV1000-CPU01-EV1 CV2000-CPU01-EV1 CVM1-CPU01-EV□ CVM1-CPU11-EV□ CVM1-CPU21-EV□	Features a connector for RS-232C connections (selectable/9-pin)	CVM1/CV-series CV500 CV1000 CV2000 CVM1

**Note**

A communication board is required with the CPU units marked with an asterisk.

### CPUs (For Connection Via an NT Link)

Name	Model	PC Type
CPM1-10CDR-□ CPM1-20CDR-□ CPM1-30CDR-□	RS-232C adapter, RS-422A adapter connected to the peripheral port	C-series CQM1
CQM1-CPU41-E CQM1-CPU42-E CQM1-CPU43-E CQM1-CPU44-E	Features a 9-pin connector for RS-232C connections	C-series CQM1
C200HS-CPU21-E C200HS-CPU23-E C200HS-CPU31-E C200HS-CPU33-E	Features a 9-pin connector for RS-232C connections	C200HS
C200HE-CPU32-E(*) C200HE-CPU42-E	Features a connector for RS-232C connections (selectable/9-pin)	C-series C200HE
C200HG-CPU33-E(*) C200HG-CPU43-E C200HG-CPU53-E(*) C200HG-CPU63-E	Features a connector for RS-232C connections (selectable/9-pin)	C-series C200HG
C200HX-CPU34-E(*) C200HX-CPU44-E C200HX-CPU54-E(*) C200HX-CPU64-E	Features a connector for RS-232C connections (selectable/9-pin type)	C-series C200HX
CV500-CPU01-EV1 CV1000-CPU01-EV1 CV2000-CPU01-EV1 CVM1-CPU01-EV2 CVM1-CPU11-EV2 CVM1-CPU21-EV2	Features a 9-pin connector for RS-232C connections	CVM1/CV-series CV500 CV1000 CV2000

**Note** A communication board is required with the CPU units marked with an asterisk.

### CPUs (For Connection Via an NT Link (1:N))

Model	Specification	PC Type
C200HE-CPU32-E(*) C200HE-CPU42-E	Features a connector for RS-232C connections (selectable/9-pin)	C-series C200HE
C200HG-CPU33-E(*) C200HG-CPU43-E C200HG-CPU53-E(*) C200HG-CPU63-E	Features a connector for RS-232C connections (selectable/9-pin)	C-series C200HG
C200HX-CPU34-E(*) C200HX-CPU44-E C200HX-CPU54-E(*) C200HX-CPU64-E	Features a connector for RS-232C connections (selectable/9-pin type)	C-series C200HX

**Note** A communication board is required with the CPU units marked with an asterisk.

### RS-232C/RS-422 Converter Unit

Model	Specification
NT-AL001	RS-232C: 9-pin connector RS-422A: 8-pin terminal block

### RS-232C adapter, RS-422 adapter

Model	Specification
CPM1-CIF01	Acts as a relay between the RS-232C port of the NT620S/NT620C and the peripheral port of the CPM1.
CPM1-CIF11	Acts as a relay between the RS-422A port of the NT620S/NT620C and the peripheral port of the CPM1.

### Related Parts and Equipment for PT

Name	Model	Remarks
Support Tool	NT-ZA3AT-EV2	3.5 inch FD
System installer	NT620-ZS3AT-EV1 NT620-ZS3AT-EMV1	3.5 inch FD Host Link, NT Link (1:1, 1:N) Memory Link
Options	NT620C-CFL01	Replaceable backlight (NT620C)
	NT600M-KBA04	Reflection-suppressing protective sheet (NT620S)
	NT620C-KBA04	Reflection-suppressing protective sheet (NT620C)
	NT600S-KBA01	Chemical-resistant cover (NT620S)
	NT620C-KBA01	Chemical-resistant cover (NT620C)
	3G2A9-BAT08	Battery

## Parts Used for Connection

Cables with connectors

Model	Cable Length	Applicable Unit	Communication Method
XW2Z-200S	2 m	Host link units with 25-pin connectors	Host link
XW2Z-500S	5 m		
XW2Z-200T	2 m	Host link units with 9-pin connectors, CPU units	Host link, NT link
XW2Z-500T	5 m		

Connection cable

Model	Remarks
AWG28X5P IFVV-SB	Multicore cable, manufactured by Fujikura, Ltd.
CO-MA-VV-SB 5PX28AWG	Multicore cable, manufactured by Hitachi Cable, Ltd.

Applicable connectors

Name	Model	Remark
Connector	XM2A-2501	25-pin, manufactured by OMRON
	XM2A-0901	9-pin (Plug), manufactured by OMRON
	XM2D-0901	9-pin (Socket), manufactured by OMRON
	DB-25P	25-pin, manufactured by JAE
Connector cover	XM2S-2511	25-pin, manufactured by OMRON
	XM2S-0911	9-pin, manufactured by OMRON
	DB-C2-J9	25-pin, manufactured by JAE

## APPENDIX K

### Option List

#### Replaceable Backlight ... NT620C-CFL01

This is a backlight for replacement purposes.

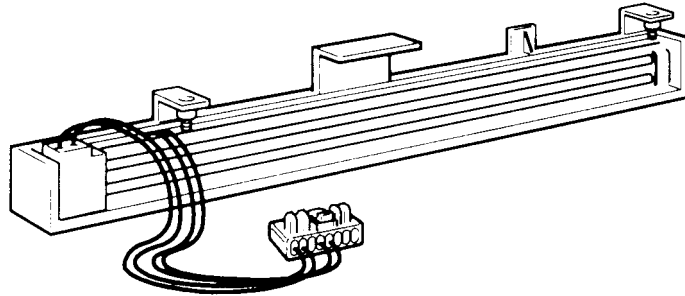

**Caution** The disposal of the NT20S (and used backlights) may be regulated by national or local authorities. Dispose of them in accordance with the laws and regulations of the relevant country and local authority.

#### Reflection-Suppressing Protective Sheet ... NT600M-KBA04 (For NT620S) NT620C-KBA04 (For NT620C)

Stuck to the display to prevent it from being soiled. The entire sheet is colorless and transparent.

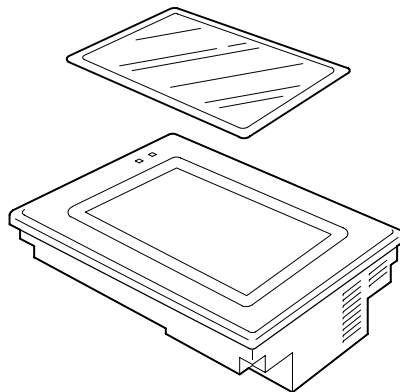

**Chemical-resistant Cover ... Type NT600S-KBA01 (For NT620S)  
Type NT620C-KBA01 (For NT620C)**

Covers the front panel and protects it from chemical agents. The entire sheet is milky white and made of silicone rubber.

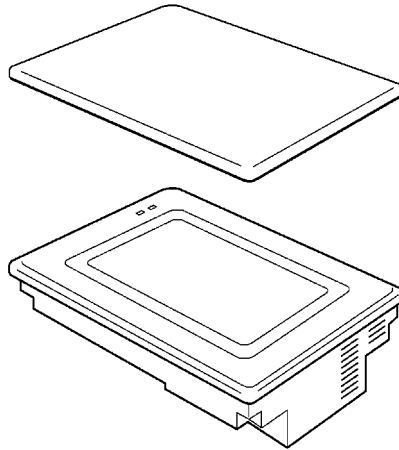

The protection the cover affords is summarized below.

Protects Against	Does Not Protect Against
Boric acid Sulfuric acid Nitric acid Ammonia gas Carbon dioxide Phenol Glycerin Ammonia water Calcium chloride Developing fluid ("hypo") Acetaldehyde Lard	Hexane Lubricating oils Benzene Butane Carbonic acid Chlorinated solvents Napthalene Soya oil Toluene

For information on protection against chemical agents not included in the table above, please ask OMRON. (If it is a chemical agent to which silicone rubber is recognized to be resistant, the cover can be used with confidence even if that chemical agent is not listed in the "Protects Against" column above.)

**Reference**

- This cover does not afford protection against all chemical agents.
- Since the cover is milky white, it reduces the clarity of the display a little.
- This cover is intended to be affixed to the display in order to provide protection against chemical agents. It will not provide protection against chemical agents that enter through the installation panel or through the gap between the cover and the display.

**Battery ... 3G2A9-BAT08**

This is a lithium battery used for memory backup.

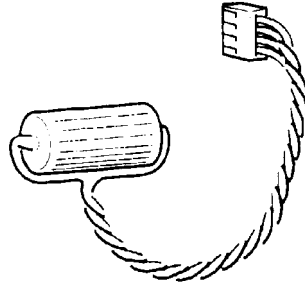

## APPENDIX L

### PC Memory Map

#### OMRON C-Series Memory Map

Area		IR Area	HR Area	AR Area	Link Relay Area	Timer/Counter Area	DM Area
Ladder type	C20H C28H C40H C60H	0000 to 0255	0000 to 0099	0000 to 0027	0000 to 0063	0000 to 0511	0000 to 1999
	C120	0000 to 0063	0000 to 0031			0000 to 0127	0000 to 0051
	C200H	0000 to 0255	0000 to 0099	0000 to 0027	0000 to 0063	0000 to 0511	0000 to 1999
	C200HS C200HE C200HG C200HX	0000 to 0511	0000 to 0099	0000 to 0027	0000 to 0063	0000 to 0511	0000 to 6655 7000 to 9999
	C500	0000 to 0063	0000 to 0031		0000 to 0031	0000 to 0127	0000 to 0511
	C1000H						0000 to 4095
	C2000(H) CQM1	0000 to 0255	0000 to 0099	0000 to 0027	0000 to 0063	0000 to 0051	0000 to 6655
	CPM1	0000 to 0019 0200 to 0255	0000 to 0019	0000 to 0015	0000 to 0015	0000 to 0127	0000 to 1023 6144 to 6655

#### OMRON CV-Series Memory Map

Area	IR Area	HR Area (*1)	AR Area	Link Relay Area	Timer/Counter Area	DM Area
CV500 CVM1-CPU01 (-EV□)	0000 to 2555		0000 to 0511		0000 to 0511	0000 to 8191
CV1000 CVM1-CPU11 (-EV□) CV2000 CVM1-CPU21 (-EV□)	0000 to 2555		0000 to 0511		0000 to 1023	0000 to 9999 (*2)

(\*1) Included in the IR area in the case of CVM1/CV-series PCs.

(\*2) This is the area that can be used with an NT620S/620C. The DM area itself occupies the range 00000 to 24575.



## APPENDIX M

### Special Characters

#### English Character Codes

Pin 2 of SW2 must be ON to enable English language messages to use the following codes.

Example: Hex code is represented by 30, decimal code by 48, and character by 0.

30	0
48	

Code 20 and 32 in the table represents a space, as indicated by "SP".

Hex Digits 1st → 2nd ↓	2-		3-		4-		5-		6-		7-		8-		9-	
-0	20	SP	30	0	40	@	50	P	60	'	70	p	80	Ç	90	É
	32		48		64		80		96		112		128		144	
-1	21	!	31	1	41	A	51	Q	61	a	71	q	81	ü	91	æ
	33		49		65		81		97		113		129		145	
-2	22	"	32	2	42	B	52	R	62	b	72	r	82	é	92	Æ
	34		50		66		82		98		114		130		146	
-3	23	#	33	3	43	C	53	S	63	c	73	s	83	â	93	ô
	35		51		67		83		99		115		131		147	
-4	24	\$	34	4	44	D	54	T	64	d	74	t	84	ä	94	ö
	36		52		68		84		100		116		132		148	
-5	25	%	35	5	45	E	55	U	65	e	75	u	85	à	95	ò
	37		53		69		85		101		117		133		149	
-6	26	&	36	6	46	F	56	V	66	f	76	v	86	å	96	û
	38		54		70		86		102		118		134		150	
-7	27	'	37	7	47	G	57	W	67	g	77	w	87	ç	97	ù
	39		55		71		87		103		119		135		151	
-8	28	(	38	8	48	H	58	X	68	h	78	x	88	ê	98	ÿ
	40		56		72		88		104		120		136		152	
-9	29	)	39	9	49	I	59	Y	69	i	79	y	89	ë	99	Ö
	41		57		73		89		105		121		137		153	
-A	2A	*	3A	:	4A	J	5A	Z	6A	j	7A	z	8A	è	9A	Ü
	42		58		74		90		106		122		138		154	
-B	2B	+	3B	;	4B	K	5B	[	6B	k	7B	{	8B	ï	9B	ç
	43		59		75		91		107		123		139		155	
-C	2C	,	3C	<	4C	L	5C	\	6C	l	7C		8C	î	9C	£
	44		60		76		92		108		124		140		156	
-D	2D	-	3D	=	4D	M	5D	]	6D	m	7D	}	8D	ì	9D	¥
	45		61		77		93		109		125		141		157	
-E	2E	.	3E	>	4E	N	5E	^	6E	n	7E	~	8E	Ä	9E	Pt
	46		62		78		94		110		126		142		158	
-F	2F	/	3F	?	4F	O	5F	_	6F	o	7F	◊	8F	Å	9F	f
	47		63		79		95		111		127		143		159	

Hex Digits 1st → 2nd ↓	A-		B-		C-		D-		E-		F-	
-0	A0	á	B0	⋮	C0	└	D0	⊥	E0	α	F0	≡
	160		176	⋮	192	└	208	⊥	224		240	
-1	A1	í	B1	■	C1	└	D1	⊥	E1	β	F1	±
	161		177	■	193	└	209	⊥	225		241	
-2	A2	ó	B2	⋮	C2	└	D2	⊥	E2	Γ	F2	≥
	162		178	⋮	194	└	210	⊥	226		242	
-3	A3	ú	B3	└	C3	└	D3	⊥	E3	π	F3	≤
	163		179	└	195	└	211	⊥	227		243	
-4	A4	ñ	B4	└	C4	—	D4	⊥	E4	Σ	F4	∫
	164		180	└	196	—	212	⊥	228		244	
-5	A5	Ñ	B5	≡	C5	+	D5	F	E5	σ	F5	J
	165		181	≡	197	+	213	F	229		245	
-6	A6	á	B6	⊥	C6	≡	D6	⊥	E6	μ	F6	÷
	166		182	⊥	198	≡	214	⊥	230		246	
-7	A7	ó	B7	⊥	C7	⊥	D7	⊥	E7	τ	F7	≈
	167		183	⊥	199	⊥	215	⊥	231		247	
-8	A8	í	B8	└	C8	⊥	D8	≡	E8	Φ	F8	°
	168		184	└	200	⊥	216	≡	232		248	
-9	A9	└	B9	≡	C9	⊥	D9	└	E9	Θ	F9	·
	169		185	≡	201	⊥	217	└	233		249	
-A	AA	└	BA	⊥	CA	⊥	DA	└	EA	Ω	FA	* 1
	170		186	⊥	202	⊥	218	└	234		250	
-B	AB	1/2	BB	└	CB	⊥	DB	■	EB	δ	FB	* 1
	171		187	└	203	⊥	219	■	235		251	
-C	AC	1/4	BC	└	CC	⊥	DC	■	EC	∞	FC	* 1
	172		188	└	204	⊥	220	■	236		252	
-D	AD	i	BD	⊥	CD	≡	DD	■	ED	∅	FD	* 1
	173		189	⊥	205	≡	221	■	237		253	
-E	AE	«	BE	≡	CE	⊥	DE	■	EE	ε	FE	* 2
	174		190	≡	206	⊥	222	■	238		254	
-F	AF	»	BF	└	CF	⊥	DF	■	EF	∩	FF	* 3
	175		191	└	207	⊥	223	■	239		255	

- \* 1: Used as the prefix for library data codes (2 bytes).
- \* 2: Used as the prefix for image data codes (2 bytes).
- \* 3: Used as the prefix for mark data codes (2 bytes).

**Note** In order to input these characters using the support tool, enter the relevant character code with the numeral keys while holding down the ALT key.

# INDEX

## A

Alarm list display	192, 247
Alarm list function	143
Alarm lists	15, 247
Alarm messages	247
Allocatable bits and words	200
Allocated bit	11
Allocated word	11
Allocation of ten-key	174
Alternate (Touch switch)	234
Apex interval (broken line graph)	156
Arc	131
Automatic reset	302

## B

Back col	138
Background color	132
Bar graph	145
Battery	263
Battery	353
Baud rate	56
Bit memory table	15,143,194,247
Broken line graph	153
Buzzer attribute	138, 259

## C

Cable	332, 343, 350
Cable Preparation	340
Cables with connectors	350
Cautions on replacing the NT620S/NT620C	312
CFL case lid	23, 308
Change the lamp display status	232

Change the statuses of the touch switches	236
Changing displayed numeral or character-strings	221, 223
Changing displayed numerals or character-strings	221
Changing the contents of allocated bits	232
Changing the contents of allocated words	221, 223, 230
Changing the system setting	60
Character keys	167
Characters	140
Character-string	14
Character-string input notify command (Sent from PT to host)	292
Character-string memory table	139
Character-string memory table clear command (Sent from host to PT)	288
Character-string memory table display	220
Character-string memory table read command (Sent from host to PT)	279
Character-string memory table write command (Sent from host to PT)	285
Character-string setting	182
Character-string setting screen	136
Character-string setting strobe flag	244, 264
Check sum	274
Checking and setting the calendar and time	113
Checking the battery voltage	107
Checking the buzzer	105
Checking the communications	102
Checking the LCD/EL display	104
Checking the LED	106
Checking the printer interface	112
Checking the PT setting status	116

Checking the screen memory .....	110
Checking the touch switches .....	100
Checking the upper/lower limit .....	171
Chemical-resistant cover .....	352
Child screens .....	135, 136
Circle .....	131
Classification of screens .....	135
Cleaning method .....	310
Clock function .....	251
Close .....	187
Color display .....	126
Color of "Transparency" .....	127
Commands .....	269
Command transmission intervals .....	273
Communication board .....	12, 40
Communication conditions for memory link .....	78
Communication errors .....	302
Communications specifications .....	319
Comparison between NT620S and NT620C .....	5
Compatible PCs .....	32, 44, 49
Compatibility .....	5
Confirming the communications between the NT620S/620C and the PC .....	84
Connecting the NT620S/620C .....	33
Connecting to the support tool .....	29
Connector .....	332, 343, 350
Connecting a printer .....	57
Connector cover .....	332, 343, 350
Connector cover assembly .....	342
Connector specifications .....	333
Content upgrade memory table .....	242
Continuous buzzer .....	259
Continuous screens .....	136

Continuous sound .....	87
Contrast control .....	23
Control bits .....	232, 234
Control keys .....	167
Control timing .....	261
Controlling the display elements .....	201
Copy key function (Touch switch) .....	168
Copy memory table setting .....	226
Copy type .....	226, 228
Copying the memory table .....	226
CPM1-CIF01 .....	42
CPU .....	41, 347, 348
Creating screen data .....	119
Crimp terminals .....	28
Currently displayed screen .....	212, 213
Cursor moving key function (Touch switch) .....	168
Cursor moving keys .....	188
C200HX/HG/HE .....	10

## D

Data write commands/responses .....	270
Data bit length .....	56
Data read commands/responses .....	269
Date and time display .....	252
Date and time setting .....	114, 252
Decimal fraction .....	176
Deletion of system program .....	31
Description of parts .....	22
Determines the character-string memory table number .....	244
Determines the numeral memory table number .....	241
Determining touch switch status .....	237
Difference between image data and library data .....	130

Dimensions .....	318
Dimensions (NT-AL001) .....	324
Dimensions for installation .....	323
DIP switch .....	23, 41
DIP switch statuses .....	109
DIP switch settings .....	24
Direct connection data setting .....	121
Direct connection function .....	11, 119
Direct information .....	300
Direct specification .....	215, 217, 221
Disable the input of numerical values and character-strings .....	260
Disable the opening of windows .....	259
Disabling character-string input .....	245
Disabling numeral input .....	243
Display .....	22
Display capacity .....	315
Display colors .....	132
Display element specifications .....	316
Display elements .....	124
Display frame (Touch switch) .....	163
Display history initialization .....	259
Display specifications .....	314
Displaying the alarm history .....	196
Displaying the numeral memory table .....	219

## E

Edit screen .....	121
EL display .....	104
End plate .....	181
Enlargement .....	130
Entering the numeral values .....	176
Enter the character-strings .....	183
ERR ON .....	88

Error messages .....	300
Error response (sent from PT to host) .....	296
Expansion I/O connector .....	23

## F

FA site .....	2
Factory setting .....	24
Fan .....	131
“File List” screen .....	120
File units .....	121
Flashing display .....	131, 133
Flow control .....	56
Forced Initialization .....	67
For your guidance .....	246

## G

General specifications .....	313
GR terminal .....	23, 27
Grounding .....	27
Guide display .....	158

## H

Handling the RS-232C/RS-422 converter unit .....	324
Hardware faults .....	298
History attribute .....	138
Holes for mounting expansion I/O equipment ...	23
Host I/F tool connector .....	23
Host link .....	11
Host link method .....	30
Host link unit .....	31, 36, 346
Host settings .....	56

## I

I/O check .....	100
-----------------	-----

I/O relay	269
Image data	129
Image library (Alarm list)	192
Image library lamp	160
Image/library data corresponding to alarm messages	248
Important points concerning the numeral memory tables used for clock function	253, 255
Important points relating to notification operations (Touch switch)	235
Important points when writing a character-string	221
Important points when writing memory table number	224
In order of frequency (Alarm history)	197
In order of frequency (Display history recording)	97
In. Scr (Support tool)	85
Indirect specification	215, 217, 223
Initial operation of the input keys	177
Initialization error	301
Initialization of the display history data memory	70
Initialization of the memory tables	68
Initialization of the screen data	66
Initialization setting	216, 218
Initialize the screen data memory	80
Initializing	65
Initializing memory	65
Input key function (Touch switches)	167
Inspection method	310
Installation	25
Installation and removal (NT-AL001)	325
Installation environment	326
Installation to the operation panel	25

Integer part	176
Intermittent buzzer (long)	259
Intermittent buzzer (short)	259
Internal Processing	329

## K

Key press sound	86
Keyboard	186

## L

LAMP	13, 157, 231
LCD display	104
Library data	129
Life of the backlight	304
Line types	131
Long-distance transmission	35
Long intermittent sound	87, 138
LSS	40, 41, 42

## M

Maintenance	304
Maintenance of the NT620S/620C	304
Maintenance mode	61, 64
Making the cable for connection	332
Making the cable for connection to the support tool	343
Mark data	300
Marks	128
Maximum amount of various data	317
Maximum number of NT620S/NT620Cs Connectable to One port	50
Memory link	17, 56, 75, 268
Memory size	119
Memory switch menu	72
Memory switches	72

Memory table from 0 to 255 .....	140
Memory table from 256 to 999 .....	140
Menu tree .....	62
Message (Alarm list) .....	192
Message (Bit memory table) .....	144
Method for specifying commands .....	272
Model list .....	346
Momentary (Touch switches) .....	234
Monitoring .....	15

## N

9-pin .....	34
Normal display .....	131, 133
Normal lamp .....	157
Normal screen .....	135
Normal type (Trend graph) .....	149
Notification of numbers to the PC .....	241
Notification of the operating status to the PC .....	263
Notify bits .....	234, 237
Notify command .....	270
Notifying the display elements .....	204
Notifying the display screen to the PC .....	212
Notifying the PC .....	237, 244
NT-AL001 .....	9, 338
NT link .....	11, 12, 44, 74
NT link (1:1) .....	12, 44
NT link (1:N) .....	12, 49
NT model .....	119
NT620S/620C status control .....	257
NT620S/620C status notification .....	263
Number of character-string memory tables .....	139
Number of colors .....	130
Number of numeral memory tables .....	142

Number of registration words .....	216, 218
Number of words for screen element registration .....	330
Numeral .....	14, 142
Numeral memory table .....	142, 218
Numeral memory table clear command (sent from host to PT) .....	287
Numeral memory tables 247 through 253 .....	252
Numeral memory tables numbered 254 and 255 .....	252
Numeral memory table read command (sent from host to PT) .....	277
Numeral memory table write command (sent from host to PT) .....	283
Numeral setting .....	136, 170
Numeral setting attribute .....	138
Numeral setting strobe flag .....	241, 264
Numeral/character-string input .....	260
Numerical input notify command (sent from PT to host) .....	291

## O

1:1 NT link .....	12
Occurrence (Alarm history) .....	197
Occurrence (Display history recording function) .....	97
OMRON's PC .....	9
Open .....	187
Opening and closing .....	187
Opening and closing windows .....	187
Operating panel .....	3
Operating status .....	2, 263
Operation flow by the system menu .....	59
Operation modes .....	61
Operations with the system menu .....	63
Option list .....	349

Order for writing (Memory table copy) .....	205
Order of priority of input communication commands .....	274
Order of priority for registration .....	330
ORed .....	126
Outline colors .....	132
Overlapping screen .....	135, 209, 213

## P

Page number display .....	136
Panel fittings .....	26
Panel specifications .....	314
Parent screen .....	135, 136
Parity .....	56
PC .....	32
PC memory map .....	354
PC switch settings .....	35, 46
PC system setting .....	40, 41, 42, 44
PC system setting area .....	46, 47, 55
Pen recorder type (Trend graph) .....	149
Performance specifications .....	314
Peripheral tool .....	40, 41, 42, 44
Polygon .....	131
Pop-up window function .....	185
Power input terminals .....	23, 27
Power LED .....	22
Power supply connection .....	27
Power supply specifications .....	27
Precautions to be observed during the screen data transmission .....	83
Press .....	64
Printer cable .....	350
Printer connector .....	23
Printer operating status .....	264

Priority registration for processing .....	258
Procedure before operating .....	19
Processing differences according to command length .....	273
Programmable terminal .....	2
PT .....	2, 346
PT memory .....	17, 269
PT memory batch write (FILL) command (sent from host to PT) .....	286
PT memory read command (sent from host to PT) .....	275
PT memory write command (sent from host to PT) .....	281
PT operating status .....	263
PT status control area .....	15, 202
PT status control bits .....	257
PT status notify area .....	16, 204
PT status notify command (sent from PT to host) .....	293
PT status .....	263

## R

Receive error .....	302
Recommended cables .....	332
Recommended printer .....	44
Reflection-suppressing protective sheet .....	351
Registering the screen data .....	80
Replaceable backlight .....	351
Replacing the backlight .....	304
Replacing the battery .....	307
Report timing .....	265
Re-send command .....	270
Re-send request command .....	295
Reset (Touch switches) .....	234
Reset switch .....	23



Response .....	56
Restrictions when creating the thumb wheel type .....	181
Resume function .....	91
Reverse and flashing display .....	131, 133
Reverse display .....	131, 133
RS-232C adapter .....	349
RS-232C cable .....	29
RS-232C communication .....	268, 271
RS-232C/RS-422 converter unit .....	10, 48, 324, 349
RS-232C/RS-422 converter unit (NT-AL001) .....	48, 51
RS-422A adapter .....	349
RS-422A cables .....	52
RS-422A communication .....	268
RS-485 cables .....	53
RUN LED .....	22
Run mode .....	61

## S

Screen .....	124
Screen attributes .....	138
Screen changeover function (Bit memory table) .....	143
Screen data .....	300
Screen data memory .....	65
Screen display .....	258
Screen display timing .....	211
Screen No. "0" .....	125
Screen No. "1999" .....	125
Screen No. 1980 through No. 1996 .....	125
Screen No. 1997 .....	99, 125
Screen No. 1998 .....	99, 125
Screen number range 1900 to 1979 .....	187

Screen numbers .....	125
Screen print key function (Touch switch) .....	169
Screen printing .....	259
Screen printing function .....	93
Screen saver function .....	89
Screen switch setting .....	207
Screen switch strobe .....	208, 212, 264
Screen switching timing .....	208
Screen switchover return key .....	165
Screen to be displayed at the startup of the system .....	125
"Scr list" screen .....	121
Scrolling keys shown in reverse video .....	194
Scrolling the message .....	193
Selecting the communication speed .....	76
Selecting the host communication method .....	74
Selecting the items .....	64
Sending error .....	302
Set (Touch switches) .....	234
Setting error .....	301
Setting status .....	116
Setting the support tool .....	118
Setting the word of the numeral memory table .....	218
Setting the words for the character-string memory tables .....	216
Setting unit numbers .....	77
Short intermittent sound .....	87, 138
Smoothing .....	130
Sound the buzzer .....	87
Spare PT .....	304
Special characters .....	355
Special features .....	318
Specification .....	313

Specifying the numeral setting input column . . .	175
Square . . . . .	131
Stand Alone Functions . . . . .	165
Standard equivalent to IP65 . . . . .	4
Starting . . . . .	60
Straight lines . . . . .	131
Storing . . . . .	328
Stop bit . . . . .	56
Support tool . . . . .	119, 3, 80
SW1 . . . . .	23
SW2 . . . . .	23
Switch character-strings according to the situation . . . . .	226
Switch over the screen . . . . .	165
Switching the continuous screen . . . . .	137
Switching the screen display . . . . .	207, 210
Switching to the RUN mode . . . . .	84
System (Numeral setting attribute) . . . . .	137, 173
System installer . . . . .	17, 30, 74, 349
System menu . . . . .	61
System program . . . . .	300
System program transfer . . . . .	31

## T

Temporary input fields . . . . .	189
Ten-key . . . . .	173
Ten-key type . . . . .	172, 175
Terminal resistor . . . . .	52
The lamp control bit . . . . .	232, 234, 236
Thumb wheel type . . . . .	172, 179
Tiling pattern . . . . .	132
To stop the buzzer sound . . . . .	87
Tool I/F . . . . .	103
Tool settings . . . . .	118

Touch switch (Screen printing function) . . . . .	93
Touch switch input notify command (sent from PT to host) . . . . .	289
Touch switches . . . . .	14, 161, 234
Touch switches (Displaying the system menu) . . . . .	63
Touch switches to display the system menu . . . . .	63
Transmission . . . . .	80
Transmit mode . . . . .	62, 64, 81, 123
Transmitting screen data . . . . .	123
Transparent display . . . . .	126
Transporting . . . . .	328
Trend graph . . . . .	148
Turning ON the power . . . . .	60
25-pin . . . . .	33

## U

Using the display history recording function . . . . .	96
Upgrading graphs . . . . .	230
Use touch switches for notification to the PC . . . . .	234
User (Numeral setting attribute) . . . . .	138, 173

## V

Virtual PC area . . . . .	269
Voltage of battery . . . . .	300

## W

Warning label . . . . .	23
Warning lamp . . . . .	261
Waterproofed . . . . .	4
Window . . . . .	185
Window keys (Touch switches) . . . . .	167
Window opening . . . . .	261
Window screens and display elements . . . . .	187

Wiring ..... 333, 343  
Word address setting error ..... 301

**Z**

Zero suppress ..... 143



## Revision History

A manual revision code appears as a suffix to the catalog number on the front cover of the manual.

Cat. No. V033-E1-4

↑  
Revision code

The following table outlines the changes made to the manual during each revision. Page numbers refer to the previous version.

Revision code	Date	Revised content
1	September 1995	Original production
2	August 1996	Revisions associated with model change xi, P.20, P.281 Correction of DIP switch description P.22
3	May 1997	Additional functions due to additions to installer (NT link 1:N, memory link) Correction of errors Addition of text to comply with EC directives
4	August 1997	Correction of errors